

TIMELESS EXCLUSIVE HANDLES

KATALOG UND PREISLISTE
CATALOGUE AND PRICE LIST



DATEC
TYMAN_{group}

INDEX

GENERAL INDEX

EINLEITUNG INTRODUCTION	11
----------------------------	----



TÜR- UND FENSTERBESCHLÄGE DOOR AND WINDOW HANDLES	22
FEUERSCHUTZ FIRE PROOF	180
SCHUTZGARNITUREN SECURITY SETS	192
KNÖPFE KNOBS	252
TÜRSTOPPER DOOR STOPS	257
HEBE SCHIEBETÜRBESCHLÄGE LIFT AND SLIDE PULL HANDLES	258



TÜR- UND FENSTERBESCHLÄGE DOOR AND WINDOW HANDLES	266
STOßGRIFFE PULL HANDLES	420
HEBE/SCHIEBETÜRBESCHLÄGE LIFT AND SLIDE PULL HANDLES	424
GANZGLASTÜRBESCHLÄGE GLASS DOORS	436
MÖBELBESCHLÄGE FURNITURE HARDWARE	444

BESCHLAGDISPLAY DISPLAY	452
TECHINISCHE INFORMATIONEN TECHNICAL INFO	456
CODE-INDEX CODE INDEX	500

Tür- und Fensterbeschläge

Door and window handles

JATEC



Bauhaus Eckig
J04MRJ30 p.24



Bauhaus Eckig mit Schraubköpfen
J04MRJ04 p.28



Bauhaus Rund
J04MRJ01 p.32



Belle Epoque
J12MRJ13 p.38



Belvedere
J16MPJ16 p.44



Escalier
J03MRJ03 p.52



Flux
J20MRJ37 p.58



Id-9 Eckig
J37MRJ37 p.62



Id-9 Rund
J37MRJ01 p.66



Iq-Carre
J27MRJ30 p.70



Lighthouse
J36MRJ36 p.76



Metropol Holz
J35MPJ35 p.82



Montparnasse
J01MPJ01 p.86



Portal
711MP710 p.92



Pure Eckig
J26MRJ30 p.96



Pure Rund
J26MRJ01 p.102



Sanssouci
J18MRJ18 p.106



Sanssouci Edelstahl
J18MRJ03 p.114



Sanssouci Porzellan
J18MRJ18 p.120



Schönbrunn
J14MPJ14 p.126

INDEX

GENERAL INDEX

Tür- und Fensterbeschläge

Handles

ITC



Charme
900MRD17 p.268



Cinzia
069MRD17 p.274



Claudia
101MRD17 p.278



Epoca
800MRD17 p.284



Essence Eckig
260MRQD7 p.290



Essence Rund
260MRD17 p.296



Essence Minimal
260MR022 p.302



Ginevra
040MRD17 p.306



Harmonie Eckig
004MRQD7 p.312



Harmonie Rund
004MRD17 p.318



Ixia Eckig
J40MRQD7 p.324



Ixia Rund
J40MRD17 p.328



Ixia Minimal
J40MR022 p.332



Klass
180MRD17 p.336



Linear
002MRD17 p.342



Maybach
001MRD17 p.346



Meteor Eckig
J08MRQD7 p.352



Meteor Rund
J08MRD17 p.356



New Orbis
J07MRD17 p.360



One
10NMRD1N p.364



Padua
J02MRD17 p.368

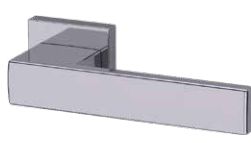

Q-Arte
124MRQD7 p.374



Sandra
168MRD17 p.378



Skyline
J06MRD17 p.384



Spring Eckig
141MRQD7 p.390



Spring Rund

141MRD17

p.394



Spring Minimal

141MR022

p.398

Feuerschutz

Fire Proof

JATEC



952 GF 914

p.182



952 GF 917

p.184



973 GF 914

p.186



973 GF 917

p.188



982 GF 922

p.190

Schutzgarnituren

Security Sets

GF1 system

JATEC



953 GF 420

p.194



955 GF 420

p.196



976 GF 373

p.198



976 GF 374

p.200



993 GF 922

p.202

INDEX

GENERAL INDEX

Schutzgarnituren Security Sets

GF2 system

JATEC



952 GF 914 p.204



973 GF 373 p.206



973 GF 374 p.208

Schutzgarnituren Security Sets

GF3 system

JATEC



351 GF 420 p.210



351 GF 421 p.212



351 GF 922 p.214



361 GF 420 p.216



371 GF 373 p.218



371 GF 374 p.220



951 GF 913 p.222

Schutzgarnituren Security Sets

AC3 system

JATEC



354 AC 420 p.224



354 AC 421 p.226



370 AC 374 p.228



950 AC 420 p.230



950 AC 913 p.232

Schutzgarnituren Security Sets

GF5 system

JATEC



CD J50 p.234



CD JQ5 p.234



J50 BY p.235



JQ5 BY p.235

Stoßgriffe Pull handles

ITC

One
10NMDXXXC0
p.422



One
10NMDXXXF0
p.423



INDEX

GENERAL INDEX

Knöpfe

Knobs

JATEC



J01PFJ01 p.254



J01PQ p.254



J02PFJ01 p.255



J02PQ p.255



J03PFJ30 p.256



J03PQ p.256

Türstopper

Door stops

JATEC



J01FE p.257



J02FE p.257

Hebe schiebetürbeschläge

Lift and slide pull handles

JATEC



Bauhaus
J04MDQ
p.260



Pure
J26MDQ
p.262



Sanssouci
J18MDC
p.264

Hebe schiebetürbeschläge

Lift and slide pull handles

DTC



Bernini
307MD0
p.426



Q-Arte
124MDQ
p.428



Spring Ecking
141MDQ
p.430



Spring Rund
141MD0
p.432



J01 PI p.434



J02 PI p.434



J03 PI p.434

INDEX

GENERAL INDEX

Ganzglastürbeschläge

Glass doors

ITC



Ambiente plus p.438



Ambition plus p.439



Avantgarde plus p.440



Compact square p.441



493 CE P39 p.442



592 CE p.442

Möbelbeschläge

Furniture Hardware

ITC



122 PN 025 p.446



J05 PN 025 p.446



J07 PN 025 p.447



J07 PN 032 p.447



J08 PN 030 p.447



536 PI p.448



J08 PI p.448



J10 PI p.449



J12 PI p.449



J71 BN

p.450



J73 BN

p.450



TYMAN

International

JATEC

DIE TYMAN INTERNATIONAL WELT DER LUXUS GRIFFE TYMAN INTERNATIONAL WORLD OF LUXURY HANDLES

Jatec ist die deutsche Premiummarke, die seit jeher für die hohe Qualität und das elegante Design ihrer Drücker bekannt ist.

Jatec liefert eine komplette Linie von Griffen und Zubehör im Coordinated Design in einer Vielzahl von Stilen, von klassisch bis modern.

Jatec wird in luxuriöser Umgebung sehr geschätzt, da es das Prestige der Türen und der Räume erhöht.

Jatec is the German brand known for the high quality and the smart design of its handles.

It features a complete range of handles and accessories with coordinated design and variety of styles, from classic to modern.

Jatec is very appreciated in luxurious environment, as it enhances the prestige of the doors and the environment.



13

JATEC MODELLE
JATEC MODELS

19

JTC MODELLE
JTC MODELS

6875

KATALOGPRODUKTE
CATALOG PRODUCTS

55

OBERFLÄCHE
FINISHES

UNSERE LÖSUNGEN GESTALTEN DIE ZUKUNFT

OUR SOLUTIONS SHAPE THE FUTURE

PARTNERSCHAFT. LEISTUNG. QUALITÄT. INNOVATION. DESIGN.
PARTNERSHIP. PERFORMANCE. QUALITY. INNOVATION. DESIGN.

Dies sind die Werte, auf denen wir unsere Identität und unsere Art, Ideen zu generieren, aufbauen.

Das Geheimnis unseres Erfolgs liegt in unserer Fähigkeit, innovative Lösungen zu entwerfen, herzustellen und umzusetzen, und in unserer Entschlossenheit, im Bereich Fenster, Türen und Vorhangfassaden einen Mehrwert zu liefern.

These are the values upon which we base our identity and our way of generating ideas.

The secret to our success lies in our ability to design, manufacture and implement cutting-edge solutions and in our singleminded determination to deliver added value in the field of windows, doors and curtain walls.



TEAMWORK
TEAMWORK



VERANTWORTUNG
RESPONSABILITY



LEIDENSCHSDE
PASSION



INNOVATION
INNOVATION

JATEC TIMELINE

1890

Jans und Roth in Offenbach bei Frankfurt am Main eine Manufaktur, in der Beschläge für Lederkoffer hergestellt wurden.

Jans and Roth founded a manufactory in Offenbach near Frankfurt am Main, In which fittings for leather cases were manufactured.

1949

Herr Jans und sein neuer Partner Heinsdorf die Produktion auf Beschläge für die stark wachsende Möbelindustrie umstellten. Jans & Heinsdorf wird gegründet.

Jans & Heinsdorf is founded, also producing fittings for the furniture industry.

1975

Anfang der Siebziger Jahre wurde das Sortiment - begleitet von zahlreichen Patenten- um Tür- und Fensterbeschläge erweitert. Das Unternehmen ändert seinen Namen in JADO.

The company changes its name to JADO. The range is expanded with door and window handles.

1982

JADO vergrößert sich durch die Übernahme von Wils&Co. (WICO), einem Hersteller von Badarmaturen. Das Unternehmen gründet Niederlassungen in ganz Europa.

JADO acquires of Wils&Co. (WICO), a producer of bathroom fixtures. The company also founds branches throughout Europe.

1992

Das Unternehmen wird in eine Aktiengesellschaft umgewandelt, die JADO AG. Die Sanitärabteilung fusioniert mit der Beschläge Abteilung unter dem Namen JADO.

The company becomes a public limited company, the JADO AG. The sanitary division merges with the fittings division under the name JADO.

2000

American Standard wird Jado's größter Aktionär.

AmericanstandardbecomesJado'slargestshareholder.

2007

Die italienische Reguitti Spa übernimmt von American Standard den Bereich Jado Beschläge.

The Italian Reguitti Spa takes over the Jado fittings division from American Standard.

2016

JADO Beschläge wird JATEC.

JADO hardware becomes JATEC.

2018

Jatec und Reguitti werden von SchlegelGiesse übernommen.

Jatec and Reguitti are acquired by SchlegelGiesse.

JTC

EIN NEUER LUXUS

A NEW LUXURY

Der Wert eines Luxusgriffs liegt nicht in seinem Preis. Echter Luxus ist die ständige Suche nach authentischer Innovation, Forschung und kreativer Freiheit, Werte, die Jatec täglich mit seinen Kunden teilt.

Handwerkskunst, Materialien, Stil und Design sind die Säulen der Qualität, auf denen jedes Projekt basiert, einschließlich JTC von Jatec, einer großen Auswahl an Tür- und Fenstergriffen mit cleverem Design, widerstandsfähigen Oberflächen und nachhaltiger Verpackung, die das Angebot erweitern um alle unterschiedlichen Bedürfnisse von Jatec-Partnern zu erfüllen.

Genießen Sie einen neuen Luxus.

The value of a luxury handle lies not in its price. Real luxury is a constant search for authentic innovation, research and creative freedom, values that Jatec shares with its customers every day.

Craftmanship, materials, style and design are the pillars of quality upon which every project is based, including JTC by Jatec, a vast range of door and window handles with clever design, resistant finishes and sustainable packaging, that expand on the offer to meet every different need of Jatec partners.

Get to a new luxury.

GET USED

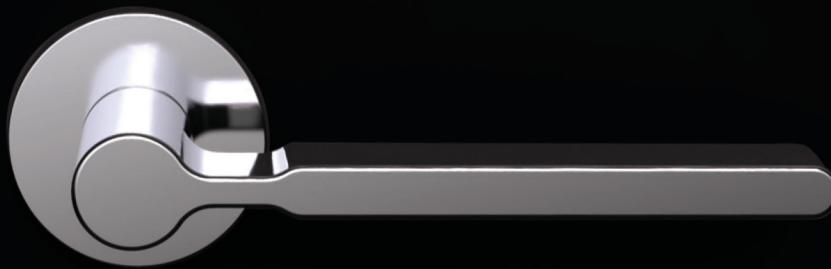

TO A NEW LUXURY

DESIGN

FOR JATEC MODELS

VON JATEC MODELLE

Die Qualität von Jatec zeichnet sich nicht nur durch Technik aus, sondern auch durch Kreativität, Kunst und Innovation. Einige Modelle von Jatec wurden von bekannten Designern entworfen, die den ausgeprägten Charakter von Jatec Drückern erweitert haben. Alle Projekte wurden dank der Zusammenarbeit mit dem technischen Büro von Reguitti realisiert.

The Jatec quality is not only technique, but creativity, art and innovation. Some Jatec models were designed by famous designers, which enhanced the distinctive character of Jatec handles. All projects have been successfully completed thanks to the partnership with the Reguitti technical office.



ARHAN MOORS

Niederländischer Trend-Designer. "Do it and Be it" ist nicht nur der Name seines berühmten Studios, sondern eine Philosophie. Ihre Kreationen sind in der Tat inspiriert durch nordisches Design und der Gestaltung einer neuen Symbiose zwischen Kunst und Studium. Mit dem Griff für Jatec hat Arjan Moors den Red Dot Design Award erhalten. Das vorgestellte Model war FLUX.

Trend Dutch designer. "Do it and Be it" is not only the name of this famous studio, but a philosophy. His creations are in fact inspired by Nordic and he shapes a new symbiosis between art and study. With Jatec handles he has won the Red Dot Design Award. The model he designed is FLUX.

Eines der renommiertesten internationalen Design-Studios. Achim Pohl und Tomas Fiegl signieren Jahr für Jahr preisgekrönte Produkte schlichter, sinnlicher Eleganz. Dabei immer zeitgemäß. Ihre Modelle sind RURE, ID-9 und METROPOL von Jatec.

One of the most prestigious international design studios. Year after year Achim Pohl and Tomas Fiegl design award-winning products with a simple, but sensual elegance that is always contemporary. Their handles are the models: PURE, ID-9 and METROPOL.



ARTEFAKT



MATTEO THUN

Italienischer Designer, dreimaliger Gewinner des "Golden Compass". Studium der Architektur, vornehmlich im Bereich Gebäude-Design aktiv (siehe auch das Side Hotel Hamburg "Hotel of the Year" im Jahr 2001), entwirft jedoch auch Alltagsgegenstände. Wie den Jatec Beschlag. Sein Model für Jatec ist IQ-CARRE.

Italian designer, three times winner of the "Golden Compass." With his degree in architecture, he is active mainly in the field of building design (see also Side Hotel Hamburg "Hotel of the Year" in 2001), but he also creates everyday objects as Jatec handles. His model for Jatec is IQ-CARRE.

Ein junges italienisches Design Studio. Alberto Gazzaroli und Andrea Gazzaroli nähern sich ihren Projekten im designorientiertem Denkprozess. Ihre Konzepte drücken einen innovativen, originellen und dynamischen Stil mit einem zeitgenössischen und funktionellen Design aus. Ihr Griff ist TRIA von Jatec.

A young Italian Design Studio. Alberto Gazzaroli and Andrea Gazzaroli approach their projects with a Design Thinking Process. Their conception express an innovative, original and dynamic style, with a contemporary and functional design. Their handle is TRIA by Jatec.



AA GAZZAROLI

Italienischer Architekt, graduiert 1982 am Polytechnikum von Mailand. Seine Aktivität fokalisiert sich besonders im Bereich von öffentlichen Projekten, wie Gesundheitsresidenzen, Sozialzentren, Sporteinrichtungen und Grünanlagen. Mit dem Türgriff „WONDER“ öffnet er sich einen neuen professionellen Kapitel, indem er seinen nüchtern-rigorosen minimalistischen Ansatz überträgt.

Italian architect graduated at the Polytechnic University of Milan in 1982. His activity has focused mainly on the design of public projects, such as health care residences, social centres, sports facilities, school buildings and green spaces. With the "WONDER" handle, the architect opens a new professional chapter, in which he brings his meticulous and clean minimalist approach.



SERGIO BARONCHELLI

ANTIGERM™



DER GRIFF, DER UNS BESCHÜTZT *THE HANDLE THAT PROTECTS US*

Statistiken zeigen, dass die Kontamination mit Bakterien, die auf den von Menschen am häufigsten verwendeten Oberflächen leben, zu den häufigsten Krankheitsursachen gehören. An öffentlichen Orten wie Kliniken, Schulen und Kindergärten werden Türgriffe täglich von einer großen Anzahl von Menschen berührt. Auf deren Oberfläche setzen sich Bakterien und Keime (die immer resistenter gegen Antibiotika werden) ab und verbreiten sich. Sie können schwerwiegende Krankheiten verursachen und bei den schwächsten Probanden sogar zum Tod führen. Sensibilität, Verantwortung, Sicherheit: Der Schutz vor Bakterien ist ein hygienisches Standardverfahren. Die AntiGerm-Beschichtung ist die Lösung zum Schutz der öffentlichen Gesundheit und für das Wohlbefinden jeder Person, die unsere Griffe berührt.

Statistics show that contamination with bacteria living over the surfaces most commonly used by people is amongst the most common causes of disease.

In public places like clinics, schools and nurseries, door handles are continuously touched by a large number of people every day. On their surface bacteria and germs (more and more resistant to antibiotic treatment) settle and spread. They can be cause of serious illnesses, even leading to death in the weakest subjects.

Sensitivity, responsibility, safety: preventing bacteria is a standard hygienic procedure.

The Antigerm™ treatment is the answer to public health responsibility and to the wellbeing of every person that touch our handles.

ANTIGERM™ IS BESONDERS GEEIGNET FÜR: *ANTIGERM™ IS ESPECIALLY INDICATED FOR:*

Antigerm™ ist die ideale Lösung für wendungen, bei denen Hygiene von entscheidender Bedeutung ist, z. B. Kindergärten, Pflegeheime, Schulen, Krankenhäuser, Freizeitzentren, Hotels und Labors.

Antigerm™ is the ideal solution for applications where hygiene is critical, such as nurseries, nursing homes, schools, hospitals, leisure centres, hotels and laboratories.

ZERTIFIZIERTE, ANTIBAKTERIELLE BESCHLÄGE *CERTIFIED ANTIBACTERIAL HANDLES*

Antigerm™ wurde von unabhängigen Behörden getestet. Die antibakterielle Behandlung von Antigerm™ für Griffe ist von imsl International Laboratories (UK Industrial Microbiological Services Limited) gemäß den Anforderungen der Norm ISO 22196: 2007 (Bestimmung der antibakteriellen Aktivität) zertifiziert.

Antigerm™ antibacterial treatment for handles is certified by IMSL international laboratories (UK Industrial Microbiological Services Limited), in accordance with the requirements of the ISO 22196:2007 standard (Determination of Antibacterial Activity).



WIE FUNKTIONIERT ES?

HOW DOES IT WORK?

Antigerm™ ist die exklusive antibakterielle SchlegelGiesse-Behandlung für Griffe. Es basiert auf einem Harz aus Silberionen und einem Lack auf Wasserbasis und enthält keine chemischen Lösungsmittel.

HALTBARKEIT

Die Antigerm-Beschichtung ist dauerhaft und funktioniert rund um die Uhr, ohne dass sie während der gesamten Lebensdauer des Produkts regeneriert werden muss. Selbst bei tiefen Kratzern auf der Oberfläche können die Silberionen ihre Arbeit fortsetzen und so die ungehinderte antibakterielle Aktivität sicherstellen, wie Labortests belegen.

KORROSIONSBESTÄNDIGKEIT

Die antibakterielle Behandlung mit Antigerm wurde gemäß der EN 1670-Zertifizierung auf Salzsprühkorrosionsbeständigkeit getestet.

Antigerm™ is the exclusive SchlegelGiesse antibacterial treatment for handles. It is based on resin composed of silver ions and water-based varnish, and contains no chemical solvents.

DURATION

The Antigerm™ treatment is permanent and it works 24/7 without needing to be regenerated throughout the life of the product. Even with deep scratches on the surface, the silver ions have the ability to continue their work, ensuring the unimpeded antibacterial activity, as demonstrated by laboratory tests.

RESISTANCE OF SURFACE

Antigerm™ antibacterial treatment was tested for salt spray corrosion resistance according to EN 1670 certification.

1.

FREISETZUNG VON SILBERIONEN SILVER IONS RELEASE

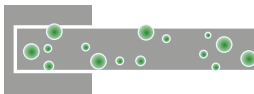

2.

BESEITIGUNG VON BAKTERIEN BACTERIAL ELIMINATION

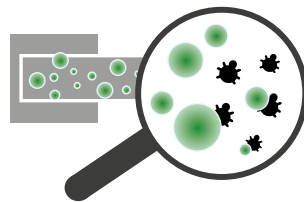

3.

24/7 SCHUTZ 24/7 PROTECTION

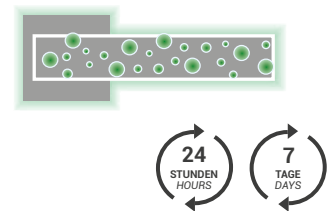

ANTIGERM™ HAS BEEN TESTED BY INDEPENDENT AUTHORITIES

ANTIGERM™ WURDE VON UNABHÄNGIGEN BEHÖRDEN GETESTET.

Die behandelten Griffe setzen langsam Silberionen frei, die innerhalb von Minuten mehr als 650 Keimarten abtöten, darunter Kolibakterien, Legionellen Pneumonien, Salmonelle Darmentzündung und mehr. Die Ionen sind für den Menschen absolut sicher, da sie Bakterien nur angreifen, indem sie ihre Fortpflanzungsfähigkeit blockieren.

The treated handles slowly release silver ions that kill more than 650 germ species in minutes, including Escherichia Coli, Legionella Pneumoniae, Salmonella Enteritidis and more. The ions are absolutely safe for humans, since they only attack bacteria by blocking their reproductive capability.

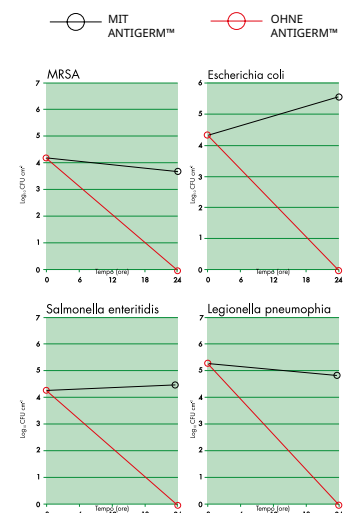

STANDARD-AUSFÜHRUNGEN VERWENDET MIT ANTIGERM™

STANDARD FINISHES WITH ANTIGERM™

Die Antigerm™ Beschichtung ist für eine Vielzahl Griffen verfügbar. Bitte kontaktieren Sie unser Vertriebsnetz für weitere Informationen.

ANTIGERM™ treatment is available on a wide range of handles. Please contact our Sales Network for more info.

MATERIALIEN

MATERIALS



MESSING BRASS

Die Legierung Messing (hauptsächlich bestehend aus Kupfer und Zink) ist ein duktileres Material und besitzt eine hohe Korrosionsbeständigkeit. Die Legierung schmilzt bei Temperaturen über 900 °. Jatec verwendet Messingbarren EN12165 CW617N.

The brass alloy (mainly composed of copper and zinc) is a ductile material, malleable and has a good resistance to corrosion. It melts at over 900 °. Jatec uses brass ingots according to EN12165 CW617N.



TEKNOMETAL

Die Legierung Zamak (hauptsächlich bestehend aus Zink, Aluminium und Magnesium) ist besonders geeignet für Druckguss bei mehr als 400 °. Die Legierung besitzt eine niedrige Korrosionsbeständigkeit. Jatec benutzt primär Zamak-Legierungen Typ 410 EN 1774.

The alloy zamak (mainly composed of zinc, aluminium and magnesium) is particularly suitable to die casting and melts at over 400 °. It is an alloy with poor corrosion resistance. Jatec uses primary zamak alloy type 410 EN 1774.



ALUMINIUM

Aluminium ist ein duktileres Metall in der Farbe Silber; es ist sehr leicht (geringes Gewicht), schmiedbar, steckbar und besitzt einen hohen Korrosionswiderstand aufgrund der Bildung einer dünnen Oxidschicht, die verhindert, dass Sauerstoff das untere Metall verätzt. Jatec verwendet Aluminiumbarren 2011. Auf Anfrage können Aluminiumgriffstücke in verschiedenen Farben, wie im Bild dargestellt, geliefert werden.

Aluminium is a ductile metal with silver colour; it is very light (low specific weight), malleable, pluggable, and has a good resistance to corrosion, due to the formation of a thin oxide layer that prevents oxygen from corroding the pluggable metal. Jatec uses aluminium board 2011. On request the handles with insert in aluminium, can be supplied in different colours as shown in the picture.



EDELSTAHL STAINLESS STEEL

Edelstahl ist eine Legierung aus Eisen und Kohlenstoff mit dem Merkmal nicht zu rosten. Auf dem Stahl erfolgt eine Passivierung, das heißt eine sehr dünne Schicht (3-5 x 10⁻⁷ mm) von Oxiden entsteht, die das Material rostfrei macht und daher keinerlei Rost bilden kann. Jatec verwendet Edelstahl 304.

The stainless steel is an alloy based on iron and carbon, with the characteristic of being stainless. On the steel occurs passivation, that means it forms a very thin layer (3-5 × 10⁻⁷ mm) of oxides which makes the material stainless and therefore rust will be avoided. Jatec uses stainless steel 304.

PERSONALISIERUNG DER PRODUKTE CUSTOMIZED PRODUCT

Jatec legt Wert auf Kundenzufriedenheit. Jede Anstrengung ist darauf ausgerichtet, die Kundenbedürfnisse zu befriedigen. Dies könnte die Möglichkeit beinhalten, einen neuen Artikel nach Kundenwunsch herzustellen. In diesen Fällen wird Jatec die Machbarkeit und die Kosten des Projekts untersuchen. Jedes neue Produkt wird dank des wertvollsten Kapitals des Unternehmens ermöglicht: Menschen, Jatec-Mitarbeiter, die mit den neuesten Technologien ausgestattet sind, sind der Grund für jedes erfolgreiche Projekt. Unsere Flexibilität und Fähigkeit, Seite an Seite mit unseren Kunden zu arbeiten, ermöglichte es uns, mehrere maßgeschneiderte Produkte zu entwickeln, die im Laufe der Jahre in unseren Katalog aufgenommen wurden.

Jatec values customer satisfaction to the point that every effort is focused on satisfying customer needs. This could include the possibility of producing a new item according to customer requirements. In those cases, Jatec will study the feasibility and costs of the project. Each new product is made possible thanks to the company most valuable asset: people. Jatec employees, equipped with the latest technologies, are the reason behind every successful project. Our flexibility and ability to work side-by-side with our customers allowed us to create several customized products that, over the years, have been added to our catalogue.

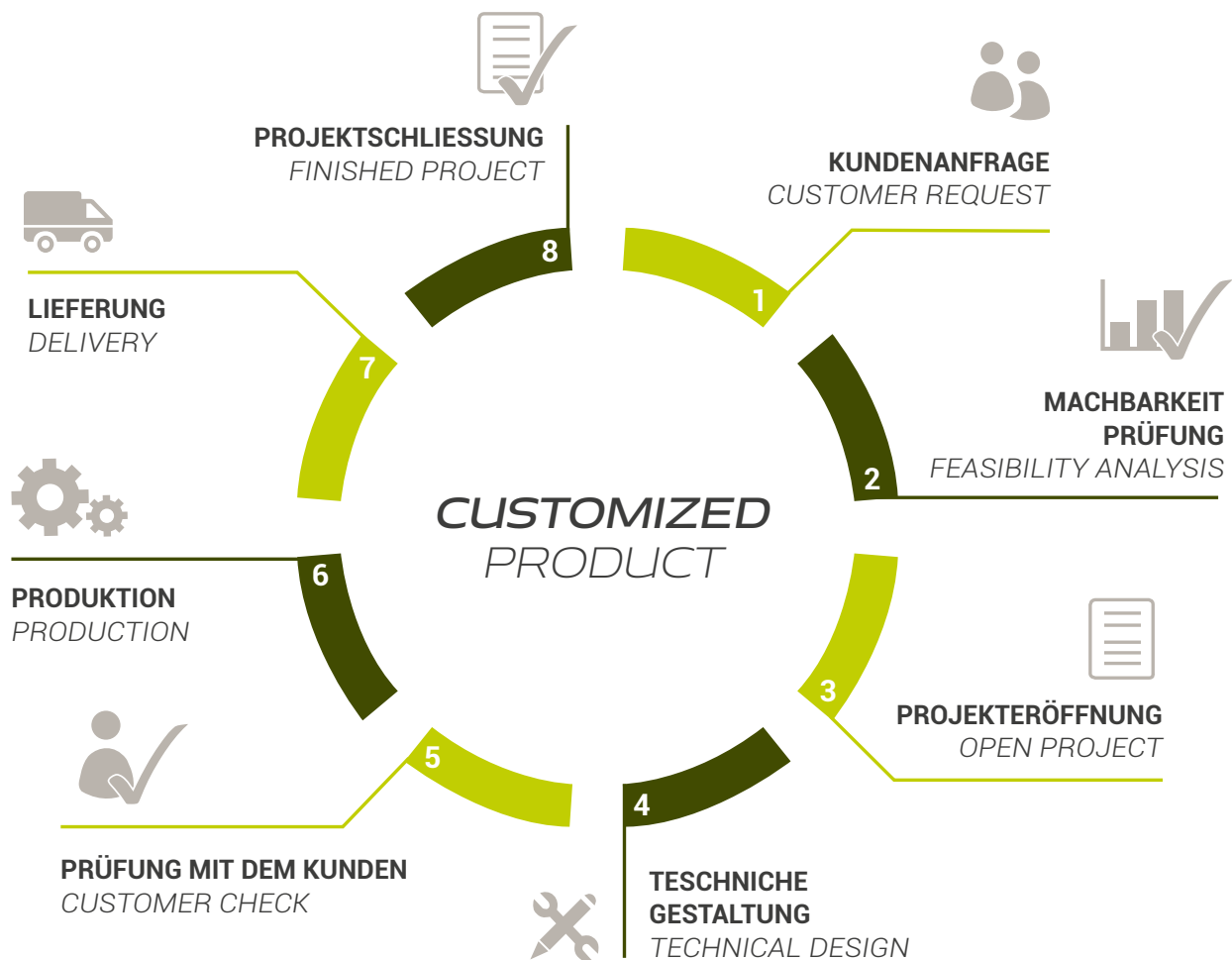

ABGESTIMMTES DESIGN

COORDINATED DESIGN



TÜRBSCHLÄGE
DOOR HANDLES



WC GARNITUREN
TOILET HANDLES



WECHSELGARNITUREN
MAIN ENTRY DOOR HANDLES SET



LANGSCHILDGARNITUREN
DOOR HANDLE ON PLATE



FENSTERBSCHLÄGE
WINDOW HANDLES



STOSSGRIFFE
PULL HANDLES FOR ENTRANCE DOOR



HEBE/SCHIEBETÜRGRIFFE
LIFT AND SLIDE PULL HANDLES



SCHIEBETÜRMUSCHELN
HANDLES AND KIT FOR SLIDING DOORS



KNÖPFE
KNOBS FOR DOOR



 JATEC

**TÜR- UND
FENSTERBESCHLÄGE**

DOOR AND WINDOW HANDLES



Bauhaus Eckig JO4

MESSING - BRASS

Datenblatt
Datasheet

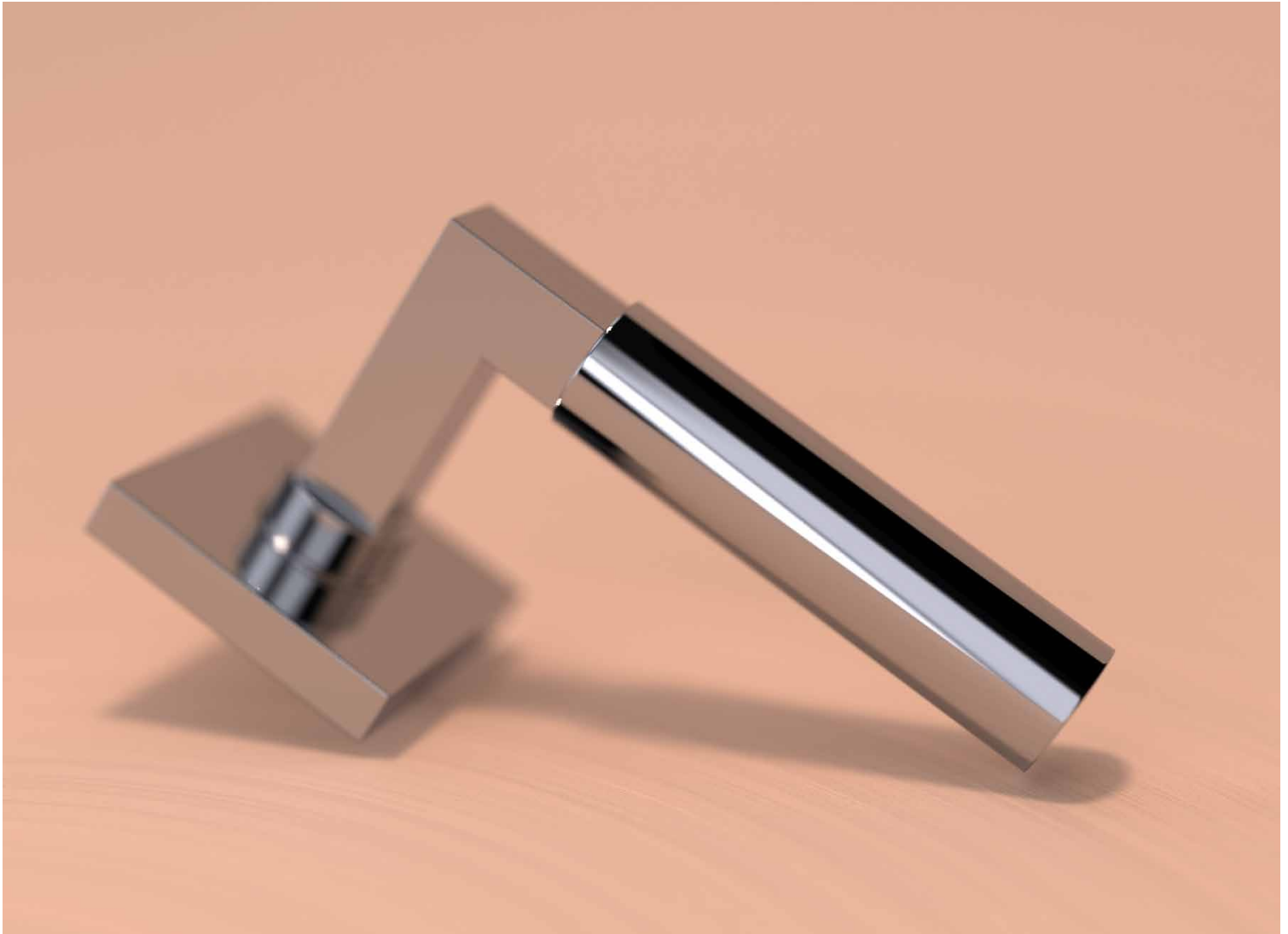

05
Chrom
Polished chrome



18
Schwarz RAL 9005
Matt black RAL 9005



46
Ultra Messing
PVD Gold



5S
Edelstahl
Stainless steel 304



K1
Nickel Spiegelpoliert Plus
Polished nickel plus

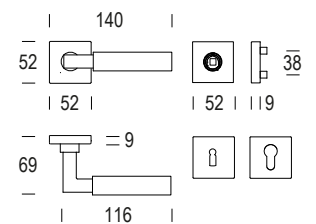

TÜRDRÜCKERGARNITUREN



J04MRJ30 *

WECHSELGARNITUREN



J04PMJ30

WC GARNITUREN



J04JRJ30

FENSTERGRIFFE



J04DKE82



J04DKC81



J04DKT81



J04TKE82

HEBE SCHIEBTÜRGRIF SET



J04MDQ01

Seite 260 / page 260



J04MRJ30	Bezeichnung - Description	Farbe - Finishes	Alte Art.-Nr. - Old code	1 Stück - Piece
	Doppelte Bezeichnung 52x52x9 mm Schlüssellochung <i>Pair lever handle on rose 52x52x9 mm key hole</i>	Chrom - Polished chrome	402-371-A00-000	1AJ04MRJ303105EJA
		Schwarz RAL 9005 - Matt black RAL 9005	402-371-A00-180	1AJ04MRJ303118EJA
		Ultra Messing - PVD Gold	402-371-A00-367	1AJ04MRJ303146EJA
		Edelstahl - Stainless steel 304	402-371-A00-055	1AJ04MRJ303155EJA
		Nickel spiegelpol. Plus - Pol. Nickel Plus	402-371-A00-004	1AJ04MRJ3031K1EJA
	Doppelte Bezeichnung 52x52x9 mm PZ <i>Pair lever handle on rose 52x52x9 mm euro profile cylinder hole</i>	Chrom - Polished chrome	402-371-B00-000	1AJ04MRJ303205EJA
		Schwarz RAL 9005 - Matt black RAL 9005	402-371-B00-180	1AJ04MRJ303218EJA
		Ultra Messing - PVD Gold	402-371-B00-367	1AJ04MRJ303246EJA
		Edelstahl - Stainless steel 304	402-371-B00-055	1AJ04MRJ303255EJA
		Nickel spiegelpol. Plus - Pol. Nickel Plus	402-371-B00-004	1AJ04MRJ3032K1EJA
	WE-Garnitur mit Knopf J03 (373) PZ rechtszeigend <i>Entrance set lever handle / knob J03 (373) Euro profile cylinder hole (right hand)</i>	Chrom - Polished chrome	402-371-H00-000	1AJ04PMJ303205JJA
		Schwarz RAL 9005 - Matt black RAL 9005	402-371-H00-180	1AJ04PMJ303218JJA
		Ultra Messing - PVD Gold	402-371-H00-367	1AJ04PMJ303246JJA
		Edelstahl - Stainless steel 304	402-371-H00-057	1AJ04PMJ303255JJA
		Nickel spiegelpol. Plus - Pol. Nickel Plus	402-371-H00-004	1AJ04PMJ3032K1JJA
	WE-Garnitur mit Knopf J03 (373) PZ linkszeigend <i>Entrance set lever handle / knob J03 (373) Euro profile cylinder hole (left hand)</i>	Chrom - Polished chrome	402-371-G00-000	1AJ04PMJ303205LJA
		Schwarz RAL 9005 - Matt black RAL 9005	402-371-G00-180	1AJ04PMJ303218LJA
		Ultra Messing - PVD Gold	402-371-G00-367	1AJ04PMJ303246LJA
		Edelstahl - Stainless steel 304	402-371-G00-057	1AJ04PMJ303255LJA
		Nickel spiegelpol. Plus - Pol. Nickel Plus	402-371-G00-004	1AJ04PMJ3032K1LJA
	WC-Garnitur mit Rosetten 52x52x9 mm mit Riegel & Schlitzschraube <i>Pair lever handle on rose 52x52x9 mm with turn and release</i>	Chrom - Polished chrome	402-371-E00-000	1AJ04JRJ304205EJA
		Schwarz RAL 9005 - Matt black RAL 9005	402-371-E00-180	1AJ04JRJ304218EJA
		Ultra Messing - PVD Gold	402-371-E00-367	1AJ04JRJ304246EJA
		Edelstahl - Stainless steel 304	402-371-E00-057	1AJ04JRJ304255EJA
		Nickel spiegelpol. Plus - Pol. Nickel Plus	402-371-E00-004	1AJ04JRJ3042K1EJA

FENSTERGRIFFE - WINDOW HANDLES

J04DKE82	Bezeichnung - Description	Farbe - Finishes	Alte Art.-Nr. - Old code	1 Stück - Piece
	Fensterlive rechteckige Ros. 33x70 ohne Rastergehäuse (separat zu notieren*) <i>Dreh Kipp on rose mm 33x70 without mechanism (to be ordered separately*)</i>	Chrom - Polished chrome	402-512-10E-000	1AJ04DKE820005XJA
		Schwarz RAL 9005 - Matt black RAL 9005	402-512-10E-180	1AJ04DKE820018XJA
		Ultra Messing - PVD Gold	402-512-10E-367	1AJ04DKE820046XJA
		Edelstahl - Stainless steel 304	402-512-10E-057	1AJ04DKE82005SXJA
		Nickel spiegelpol. Plus - Pol. Nickel Plus	402-512-10E-004	1AJ04DKE8200K1XJA
	Fensterlive rechteckige Ros. 33x70 inklusive Rastergehäuse mit 30 mm vorstehendem Stift <i>Dreh Kipp on rose mm 33x70 and 7x30 mm spindle (mechanism included)</i>	Chrom - Polished chrome	402-512-00E-000	1AJ04DKE823005XJA
		Schwarz RAL 9005 - Matt black RAL 9005	402-512-00E-180	1AJ04DKE823018XJA
		Ultra Messing - PVD Gold	402-512-00E-367	1AJ04DKE823046XJA
		Edelstahl - Stainless steel 304	402-512-00E-057	1AJ04DKE82305SXJA
		Nickel spiegelpol. Plus - Pol. Nickel Plus	402-512-00E-004	1AJ04DKE8230K1XJA
	Fensterlive rechteckige Ros. 33x70 inklusive Reastergehäuse mit 35 mm vorstehendem Stift <i>Dreh Kipp on rose mm 33x70 and 7x35 mm spindle (mechanism included)</i>	Chrom - Polished chrome	402-512-20E-000	1AJ04DKE823505XJA
		Schwarz RAL 9005 - Matt black RAL 9005	402-512-20E-180	1AJ04DKE823518XJA
		Ultra Messing - PVD Gold	402-512-20E-367	1AJ04DKE823546XJA
		Edelstahl - Stainless steel 304	402-512-20E-057	1AJ04DKE82355SXJA
		Nickel spiegelpol. Plus - Pol. Nickel Plus	402-512-20E-004	1AJ04DKE8235K1XJA

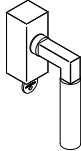
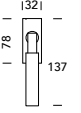
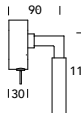

*Rastergehäuse finden Sie auf Seite 172 / For mechanism please see page 172

J04DKC81	Bezeichnung - Description	Farbe - Finishes	Alte Art.-Nr. - Old code	1 Stück - Piece
   	Fensterolive "RC 2" zertifiziert Ros. 32x78 ohne Rastergehäuse (separat zu notieren*) <i>DK with key RC2 certified on rose 32x78 without mechanism (to be ordered separately*)</i>	Chrom - Polished chrome	402-C81-10E-000	1AJ04DKC810005XJA
		Schwarz RAL 9005 - Matt black RAL 9005	402-C81-10E-180	1AJ04DKC810018XJA
		Ultra Messing - PVD Gold	402-C81-10E-367	1AJ04DKC810046XJA
	Fensterolive "RC 2" zertifiziert Ros. 32x78 inklusive Rastergehäuse mit 30 mm vorstehendem Stift <i>DK with key RC2 certified on rose 32x78 and 7x30 mm spindle (mechanism included)</i>	Chrom - Polished chrome	402-C81-00E-000	1AJ04DKC813005XJA
		Schwarz RAL 9005 - Matt black RAL 9005	402-C81-00E-180	1AJ04DKC813018XJA
		Ultra Messing - PVD Gold	402-C81-00E-367	1AJ04DKC813046XJA
	Fensterolive "RC 2" zertifiziert Ros. 32x78 inklusive Rastergehäuse mit 35 mm vorstehendem Stift <i>DK with key RC2 certified on rose 32x78 and 7x35 mm spindle (mechanism included)</i>	Chrom - Polished chrome	402-C81-20E-000	1AJ04DKC813505XJA
		Schwarz RAL 9005 - Matt black RAL 9005	402-C81-20E-180	1AJ04DKC813518XJA
		Ultra Messing - PVD Gold	402-C81-20E-367	1AJ04DKC813546XJA
		Edelstahl - Stainless steel 304	402-C81-20E-057	1AJ04DKC81355SXJA
		Nickel spiegelpol. Plus - Pol. Nickel Plus	402-C81-20E-004	1AJ04DKC8135K1XJA

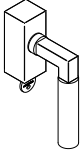
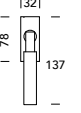
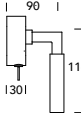
*Rastergehäuse finden Sie auf Seite 172 / For mechanism please see page 172

J04DKT81	Bezeichnung - Description	Farbe - Finishes	Alte Art.-Nr. - Old code	1 Stück - Piece
   	Fensterolive mit TBT Funktion Ros. 32x78 ohne Rastergehäuse (separat zu notieren*) <i>Dreh Kipp with key on rose 32x78 with TBT function without mechanism (to be ordered separately*)</i>	Chrom - Polished chrome	402-T81-10E-000	1AJ04DKT810005XJA
		Schwarz RAL 9005 - Matt black RAL 9005	402-T81-10E-180	1AJ04DKT810018XJA
		Ultra Messing - PVD Gold	402-T81-10E-367	1AJ04DKT810046XJA
	Fensterolive mit TBT Funktion Ros. 32x78 inklusive Rastergehäuse mit 30 mm vorstehendem Stift <i>Dreh Kipp with key on rose 32x78 with TBT function and 7x30 mm spindle (mechanism included)</i>	Chrom - Polished chrome	402-T81-00E-000	1AJ04DKT813005XJA
		Schwarz RAL 9005 - Matt black RAL 9005	402-T81-00E-180	1AJ04DKT813018XJA
		Ultra Messing - PVD Gold	402-T81-00E-367	1AJ04DKT813046XJA
	Fensterolive mit TBT Funktion Ros. 32x78 inklusive Rastergehäuse mit 35 mm vorstehendem Stift <i>Dreh Kipp with key on rose 32x78 with TBT function and 7x35 mm spindle (mechanism included)</i>	Chrom - Polished chrome	402-T81-20E-000	1AJ04DKT813505XJA
		Schwarz RAL 9005 - Matt black RAL 9005	402-T81-20E-180	1AJ04DKT813518XJA
		Ultra Messing - PVD Gold	402-T81-20E-367	1AJ04DKT813546XJA
		Edelstahl - Stainless steel 304	402-T81-20E-057	1AJ04DKT81355SXJA
		Nickel spiegelpol. Plus - Pol. Nickel Plus	402-T81-20E-004	1AJ04DKT8135K1XJA

*Rastergehäuse finden Sie auf Seite 172 / For mechanism please see page 172

J04TKE82	Bezeichnung - Description	Farbe - Finishes	Alte Art.-Nr. - Old code	1 Stück - Piece
   	Fensterolive rechteckige Ros. 33x70 ohne Rastergehäuse (separat zu notieren*) <i>TK Dreh Kipp T shape on rose mm 33x70 without mechanism (to be ordered separately*)</i>	Chrom - Polished chrome	402-512-1TE-000	1AJ04TKE820005XJA
		Schwarz RAL 9005 - Matt black RAL 9005	402-512-1TE-180	1AJ04TKE820018XJA
		Ultra Messing - PVD Gold	402-512-1TE-367	1AJ04TKE820046XJA
	Fensterolive rechteckige Ros. 33x70 inklusive Rastergehäuse mit 30 mm vorstehendem Stift <i>TK Dreh Kipp T shape on rose mm 33x70 and 7x30 mm spindle (mechanism included)</i>	Chrom - Polished chrome	402-512-0TE-000	1AJ04TKE823005XJA
		Schwarz RAL 9005 - Matt black RAL 9005	402-512-0TE-180	1AJ04TKE823018XJA
		Ultra Messing - PVD Gold	402-512-0TE-367	1AJ04TKE823046XJA
	Fensterolive rechteckige Ros. 33x70 inklusive Rastergehäuse mit 35 mm vorstehendem Stift <i>TK Dreh Kipp T shape on rose mm 33x70 and 7x35 mm spindle (mechanism included)</i>	Chrom - Polished chrome	402-512-2TE-000	1AJ04TKE823505XJA
		Schwarz RAL 9005 - Matt black RAL 9005	402-512-2TE-180	1AJ04TKE823518XJA
		Ultra Messing - PVD Gold	402-512-2TE-367	1AJ04TKE823546XJA
		Nickel spiegelpol. Plus - Pol. Nickel Plus	402-512-2TE-004	1AJ04TKE8235K1XJA

*Rastergehäuse finden Sie auf Seite 172 / For mechanism please see page 172



05
Chrom
Polished chrome



46
Ultra Messing
PVD Gold



5S
Edelstahl
Stainless steel 304



K1
Nickel Spiegelpoliert Plus
Polished nickel plus

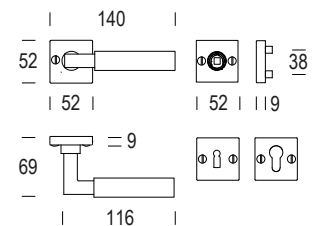

TÜRDRÜCKERGARNITUREN



J04MRJ04 *



J04MPJ04 *

WECHSELGARNITUREN



J04PMJ34



J04PMJ33

WC GARNITUREN

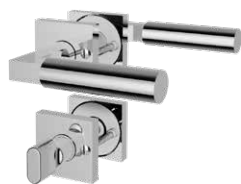

J04JRJ04



J04JPJ04

FENSTERGRIFFE



J04MAJQ6



J04SEJQ6

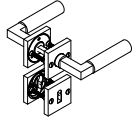
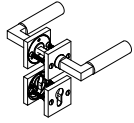
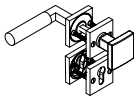
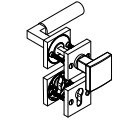
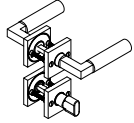
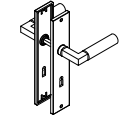
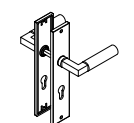

J04MRJ04	Bezeichnung - Description	Farbe - Finishes	Alte Art.-Nr. - Old code	1 Stück - Piece
	Doppelte Bezeichnung 52x52x9 mm Schlüssellochung <i>Pair lever handle on rose 52x52x9 mm key hole</i>	Chrom - Polished chrome	402-963-A00-000	1AJ04MRJ043105EJA
		Ultra Messing - PVD Gold	402-963-A00-367	1AJ04MRJ043146EJA
		Edelstahl - Stainless steel 304	402-963-A00-057	1AJ04MRJ043155EJA
		Nickel spiegelpol. Plus - Pol. Nickel Plus	402-963-A00-004	1AJ04MRJ0431K1EJA
	Doppelte Bezeichnung 52x52x9 mm PZ <i>Pair lever handle on rose 52x52x9 mm euro profile cylinder hole</i>	Chrom - Polished chrome	402-963-B00-000	1AJ04MRJ043205EJA
		Ultra Messing - PVD Gold	402-963-B00-367	1AJ04MRJ043246EJA
		Edelstahl - Stainless steel 304	402-963-B00-057	1AJ04MRJ043255EJA
		Nickel spiegelpol. Plus - Pol. Nickel Plus	402-963-B00-004	1AJ04MRJ0432K1EJA
	WE-Garnitur mit Knopf J03 (373) PZ rechtszeigend <i>Entrance set lever handle / knob J03 (373) Euro profile cylinder hole (right hand)</i>	Chrom - Polished chrome	402-963-H00-000	1AJ04PMJ343205JJA
		Ultra Messing - PVD Gold	402-963-H00-367	1AJ04PMJ343246JJA
		Edelstahl - Stainless steel 304	402-963-H00-057	1AJ04PMJ343255JJA
		Nickel spiegelpol. Plus - Pol. Nickel Plus	402-963-H00-004	1AJ04PMJ3432K1JJA
	WE-Garnitur mit Knopf J03 (373) PZ linkszeigend <i>Entrance set lever handle / knob J03 (373) Euro profile cylinder hole (left hand)</i>	Chrom - Polished chrome	402-963-G00-000	1AJ04PMJ343205LJA
		Ultra Messing - PVD Gold	402-963-G00-367	1AJ04PMJ343246LJA
		Edelstahl - Stainless steel 304	402-963-G00-057	1AJ04PMJ343255LJA
		Nickel spiegelpol. Plus - Pol. Nickel Plus	402-963-G00-004	1AJ04PMJ3432K1LJA
	WC-Garnitur mit Rosetten 52x52x9 mm mit Riegel & Schlitzschraube <i>Pair lever handle on rose 52x52x9 mm mm with turn and release</i>	Chrom - Polished chrome	402-963-E00-000	1AJ04JRJ044205EJA
		Ultra Messing - PVD Gold	402-963-E00-367	1AJ04JRJ044246EJA
		Edelstahl - Stainless steel 304	402-963-E00-057	1AJ04JRJ044255EJA
		Nickel spiegelpol. Plus - Pol. Nickel Plus	402-963-E00-004	1AJ04JRJ0442K1EJA
	ZT-Garnitur mit Schild 48x236 mm mit BB 72 mm <i>Pair lever handle on plate mm 48x236 with BB key hole 72mm</i>	Chrom - Polished chrome	402-964-100-000	1AJ04MPJ04B605XJA
		Ultra Messing - PVD Gold	402-964-100-367	1AJ04MPJ04B646XJA
		Edelstahl - Stainless steel 304	402-964-100-057	1AJ04MPJ04B655XJA
		Nickel spiegelpol. Plus - Pol. Nickel Plus	402-964-100-004	1AJ04MPJ04B6K1XJA
	ZT-Garnitur mit Schild 48x236 mm mit PZ 72 mm <i>Pair lever handle on plate mm 48x236 with Euro Profile cylinder hole 72mm</i>	Chrom - Polished chrome	402-964-200-000	1AJ04MPJ041305XJA
		Ultra Messing - PVD Gold	402-964-200-367	1AJ04MPJ041346XJA
		Edelstahl - Stainless steel 304	402-964-200-057	1AJ04MPJ041355XJA
		Nickel spiegelpol. Plus - Pol. Nickel Plus	402-964-200-004	1AJ04MPJ0413K1XJA

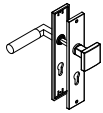
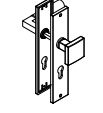
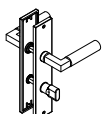
J04PMJ33	Bezeichnung - Description	Farbe - Finishes	Alte Art.-Nr. - Old code	1 Stück - Piece
	WE-Garnitur mit Knopf J03 (373) 72 mm PZ rechtszeigend <i>Entrance set lever handle / knob J03 (373) with Euro Profile cylinder hole 72mm (right hand)</i>	Chrom - Polished chrome	402-964-800-000	1AJ04PMJ331305JJA
		Ultra Messing - PVD Gold	402-964-800-367	1AJ04PMJ331346JJA
		Edelstahl - Stainless steel 304	402-964-800-057	1AJ04PMJ33135SJJA
		Nickel spiegelpol. Plus - Pol. Nickel Plus	402-964-800-004	1AJ04PMJ3313K1JJA
	WE-Garnitur mit Knopf J03 (373) 72 mm PZ linkszeigend <i>Entrance set lever handle / knob J03 (373) with Euro Profile cylinder hole 72mm (left hand)</i>	Chrom - Polished chrome	402-964-700-000	1AJ04PMJ331305LJA
		Ultra Messing - PVD Gold	402-964-700-367	1AJ04PMJ331346LJA
		Edelstahl - Stainless steel 304	402-964-700-057	1AJ04PMJ33135SLJA
		Nickel spiegelpol. Plus - Pol. Nickel Plus	402-964-700-004	1AJ04PMJ3313K1LJA
	WC-Garnitur 78 mm mit Schild 48x236 mm mit Riegel & Schlitzschraube <i>Pair lever handle on plate mm 48x236 with WC turn and release distance 78 mm</i>	Chrom - Polished chrome	402-964-600-000	1AJ04JPJ042405VJA
		Ultra Messing - PVD Gold	402-964-600-367	1AJ04JPJ042446VJA
		Edelstahl - Stainless steel 304	402-964-600-057	1AJ04JPJ04245SVJA
		Nickel spiegelpol. Plus - Pol. Nickel Plus	402-964-600-004	1AJ04JPJ0424K1VJA

FENSTERGRIFFE - WINDOW HANDLES

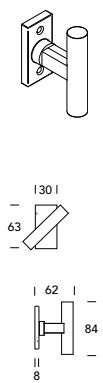
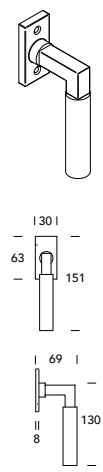
J04MAJQ6	Bezeichnung - Description	Farbe - Finishes	Alte Art.-Nr. - Old code	1 Stück - Piece
	Fensterlive mit rechteckige Rosette ohne Rasterung mit 7x30 mm Vorstehendem Stift <i>Window handle without mechanism on rectangular rose with 7mm spindle</i>	Chrom - Polished chrome	402-TQ6-000-000	1AJ04MAJQ65105XJA
		Ultra Messing - PVD Gold	402-TQ6-000-367	1AJ04MAJQ65146XJA
	Fensterlive mit rechteckige Rosette ohne Rasterung mit 7x30 mm Vorstehendem Stift <i>Window handle without mechanism on rectangular rose with 7mm spindle</i>	Chrom - Polished chrome	402-0Q6-000-000	1AJ04SEJQ65105XJA
		Ultra Messing - PVD Gold	402-0Q6-000-367	1AJ04SEJQ65146XJA

Bauhaus Rund JO4

MESSING - BRASS

Datenblatt
Datasheet



05
Chrom
Polished chrome



18
Schwarz RAL 9005
Matt black RAL 9005



46
Ultra Messing
PVD Gold



5S
Edelstahl
Stainless steel 304



K1
Nickel Spiegelpoliert Plus
Polished nickel plus

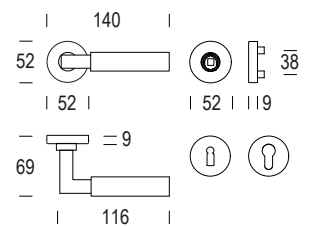
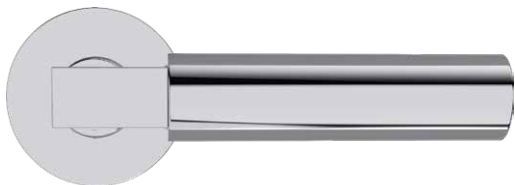

TÜRDRÜCKERGARNITUREN



J04MRJ01

WECHSELGARNITUREN



J04PMJ20

WC GARNITUREN



J04JRJ01

FENSTERGRIFFE



J04DKE66



J04DKE69



J04DKE70



J04DKC80



J04DKT80

J04MRJ01	Bezeichnung - Description	Farbe - Finishes	Alte Art.-Nr. - Old code	1 Stück - Piece
	Doppelte Bezeichnung Ø52x9 mm Schlüssellochung Pair lever handle on rose Ø52x9 mm key hole	Chrom - Polished chrome	402-373-A00-000	1AJ04MRJ013105EJA
		Schwarz RAL 9005 - Matt black RAL 9005	402-373-A00-180	1AJ04MRJ013118EJA
		Ultra Messing - PVD Gold	402-373-A00-367	1AJ04MRJ013146EJA
		Edelstahl - Stainless steel 304	402-373-A00-055	1AJ04MRJ013155EJA
		Nickel spiegelpol. Plus - Pol. Nickel Plus	402-373-A00-004	1AJ04MRJ0131K1EJA
	Doppelte Bezeichnung Ø52x9 mm PZ Pair lever handle on rose Ø52x9 mm euro profile cylinder hole	Chrom - Polished chrome	402-373-B00-000	1AJ04MRJ013205EJA
		Schwarz RAL 9005 - Matt black RAL 9005	402-373-B00-180	1AJ04MRJ013218EJA
		Ultra Messing - PVD Gold	402-373-B00-367	1AJ04MRJ013246EJA
		Edelstahl - Stainless steel 304	402-373-B00-055	1AJ04MRJ013255EJA
		Nickel spiegelpol. Plus - Pol. Nickel Plus	402-373-B00-004	1AJ04MRJ0132K1EJA
	WE-Garnitur mit Knopf J01 (420) PZ rechtszeigend Entrance set lever handle / knob J01 (420) Euro profile cylinder hole (right hand)	Chrom - Polished chrome	402-373-D00-000	1AJ04PMJ203205JJA
		Schwarz RAL 9005 - Matt black RAL 9005	402-373-D00-180	1AJ04PMJ203218JJA
		Ultra Messing - PVD Gold	402-373-D00-367	1AJ04PMJ203246JJA
		Edelstahl - Stainless steel 304	402-373-D00-057	1AJ04PMJ203255JJA
		Nickel spiegelpol. Plus - Pol. Nickel Plus	402-373-D00-004	1AJ04PMJ2032K1JJA
	WE-Garnitur mit Knopf J01 (420) PZ linkszeigend Entrance set lever handle / knob J01 (420) Euro profile cylinder hole (left hand)	Chrom - Polished chrome	402-373-C00-000	1AJ04PMJ203205LJA
		Schwarz RAL 9005 - Matt black RAL 9005	402-373-C00-180	1AJ04PMJ203218LJA
		Ultra Messing - PVD Gold	402-373-C00-367	1AJ04PMJ203246LJA
		Edelstahl - Stainless steel 304	402-373-C00-057	1AJ04PMJ203255LJA
		Nickel spiegelpol. Plus - Pol. Nickel Plus	402-373-C00-004	1AJ04PMJ2032K1LJA
	WC-Garnitur mit Rosetten Ø52x9 mm mit Riegel & Schlitzschraube Pair lever handle on rose Ø52x9 mm with turn and release	Chrom - Polished chrome	402-373-E00-000	1AJ04JRJ014205EJA
		Schwarz RAL 9005 - Matt black RAL 9005	402-373-E00-180	1AJ04JRJ014218EJA
		Ultra Messing - PVD Gold	402-373-E00-367	1AJ04JRJ014246EJA
		Edelstahl - Stainless steel 304	402-373-E00-057	1AJ04JRJ014255EJA
		Nickel spiegelpol. Plus - Pol. Nickel Plus	402-373-E00-004	1AJ04JRJ0142K1EJA

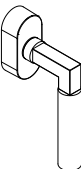
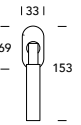
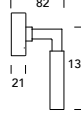
J04DKE66	Bezeichnung - Description	Farbe - Finishes	Alte Art.-Nr. - Old code	1 Stück - Piece
  	Fensterolive Ros. 33x69 ohne Rastergehäuse (separat zu notieren*) <i>Dreh Kipp on rose mm 33x69 without mechanism (to be ordered separately*)</i>	Chrom - Polished chrome	402-510-10E-000	1AJ04DKE660005XJA
		Schwarz RAL 9005 - Matt black RAL 9005	402-510-10E-180	1AJ04DKE660018XJA
		Ultra Messing - PVD Gold	402-510-10E-367	1AJ04DKE660046XJA
		Edelstahl - Stainless steel 304	402-510-10E-057	1AJ04DKE660055XJA
		Nickel spiegelpol. Plus - Pol. Nickel Plus	402-510-10E-004	1AJ04DKE6600K1XJA
	Fensterolive Ros. 33x69 inklusive Rastergehäuse mit 30 mm vorstehendem Stift <i>Dreh Kipp on rose mm 33x69 and 7x30 mm spindle (mechanism included)</i>	Chrom - Polished chrome	402-510-00E-000	1AJ04DKE663005XJA
		Schwarz RAL 9005 - Matt black RAL 9005	402-510-00E-180	1AJ04DKE663018XJA
		Ultra Messing - PVD Gold	402-510-00E-367	1AJ04DKE663046XJA
		Edelstahl - Stainless steel 304	402-510-00E-057	1AJ04DKE663055XJA
		Nickel spiegelpol. Plus - Pol. Nickel Plus	402-510-00E-004	1AJ04DKE6630K1XJA
	Fensterolive Ros. 33x69 inklusive Reastergehäuse mit 35 mm vorstehendem Stift <i>Dreh Kipp on rose mm 33x69 and 7x35 mm spindle (mechanism included)</i>	Chrom - Polished chrome	402-510-20E-000	1AJ04DKE663505XJA
		Schwarz RAL 9005 - Matt black RAL 9005	402-510-20E-180	1AJ04DKE663518XJA
		Ultra Messing - PVD Gold	402-510-20E-367	1AJ04DKE663546XJA
		Edelstahl - Stainless steel 304	402-510-20E-057	1AJ04DKE663555XJA
		Nickel spiegelpol. Plus - Pol. Nickel Plus	402-510-20E-004	1AJ04DKE6635K1XJA

*Rastergehäuse finden Sie auf Seite 172 / For mechanism please see page 172

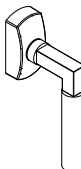
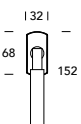
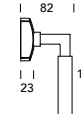
J04DKE69	Bezeichnung - Description	Farbe - Finishes	Alte Art.-Nr. - Old code	1 Stück - Piece
  	Fensterolive Ros. 33x69 ohne Rastergehäuse (separat zu notieren*) <i>Dreh Kipp on rose mm 33x69 without mechanism (to be ordered separately*)</i>	Chrom - Polished chrome	402-410-10E-000	1AJ04DKE690005XJA
		Schwarz RAL 9005 - Matt black RAL 9005	402-410-10E-180	1AJ04DKE690018XJA
		Ultra Messing - PVD Gold	402-410-10E-367	1AJ04DKE690046XJA
		Edelstahl - Stainless steel 304	402-410-10E-057	1AJ04DKE690055XJA
		Nickel spiegelpol. Plus - Pol. Nickel Plus	402-410-10E-004	1AJ04DKE6900K1XJA
	Fensterolive Ros. 33x69 inklusive Rastergehäuse mit 30 mm vorstehendem Stift <i>Dreh Kipp on rose mm 33x69 and 7x30 mm spindle (mechanism included)</i>	Chrom - Polished chrome	402-410-00E-000	1AJ04DKE693005XJA
		Schwarz RAL 9005 - Matt black RAL 9005	402-410-00E-180	1AJ04DKE693018XJA
		Ultra Messing - PVD Gold	402-410-00E-367	1AJ04DKE693046XJA
		Edelstahl - Stainless steel 304	402-410-00E-057	1AJ04DKE693055XJA
		Nickel spiegelpol. Plus - Pol. Nickel Plus	402-410-00E-004	1AJ04DKE6930K1XJA
	Fensterolive Ros. 33x69 inklusive Reastergehäuse mit 35 mm vorstehendem Stift <i>Dreh Kipp on rose mm 33x69 and 7x35 mm spindle (mechanism included)</i>	Chrom - Polished chrome	402-410-20E-000	1AJ04DKE693505XJA
		Schwarz RAL 9005 - Matt black RAL 9005	402-410-20E-180	1AJ04DKE693518XJA
		Ultra Messing - PVD Gold	402-410-20E-367	1AJ04DKE693546XJA
		Edelstahl - Stainless steel 304	402-410-20E-057	1AJ04DKE693555XJA
		Nickel spiegelpol. Plus - Pol. Nickel Plus	402-410-20E-004	1AJ04DKE6935K1XJA

*Rastergehäuse finden Sie auf Seite 172 / For mechanism please see page 172

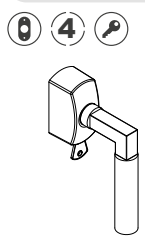
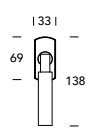
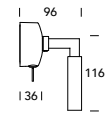
J04DKE70	Bezeichnung - Description	Farbe - Finishes	Alte Art.-Nr. - Old code	1 Stück - Piece
	Fensterolive Ros. 33x69 abschließbar ohne Rastergehäuse (separat zu notieren*) Dreh Kipp with key on rose mm 33x69 without mechanism (to be ordered separately*)	Chrom - Polished chrome	402-310-10E-000	1AJ04DKE700005XJA
		Schwarz RAL 9005 - Matt black RAL 9005	402-310-10E-180	1AJ04DKE700018XJA
		Ultra Messing - PVD Gold	402-310-10E-367	1AJ04DKE700046XJA
		Edelstahl - Stainless steel 304	402-310-10E-057	1AJ04DKE700055XJA
		Nickel spiegelpol. Plus - Pol. Nickel Plus	402-310-10E-004	1AJ04DKE7000K1XJA
	 Fensterolive Ros. 33x69 abschließbar inklusive Rastergehäuse mit 30 mm vorstehendem Stift Dreh Kipp with key on rose mm 33x69 and 7x30 mm spindle (mechanism included)	Chrom - Polished chrome	402-310-00E-000	1AJ04DKE703005XJA
		Schwarz RAL 9005 - Matt black RAL 9005	402-310-00E-180	1AJ04DKE703018XJA
		Ultra Messing - PVD Gold	402-310-00E-367	1AJ04DKE703046XJA
		Edelstahl - Stainless steel 304	402-310-00E-057	1AJ04DKE703055XJA
		Nickel spiegelpol. Plus - Pol. Nickel Plus	402-310-00E-004	1AJ04DKE7030K1XJA
 Fensterolive Ros. 33x69 abschließbar inklusive Reastergehäuse mit 35 mm vorstehendem Stift Dreh Kipp with key on rose mm 33x69 and 7x35 mm spindle (mechanism included)	Chrom - Polished chrome	402-310-20E-000	1AJ04DKE703505XJA	
	Schwarz RAL 9005 - Matt black RAL 9005	402-310-20E-180	1AJ04DKE703518XJA	
	Ultra Messing - PVD Gold	402-310-20E-367	1AJ04DKE703546XJA	
	Edelstahl - Stainless steel 304	402-310-20E-057	1AJ04DKE703555XJA	
	Nickel spiegelpol. Plus - Pol. Nickel Plus	402-310-20E-004	1AJ04DKE7035K1XJA	

*Rastergehäuse finden Sie auf Seite 172 / For mechanism please see page 172

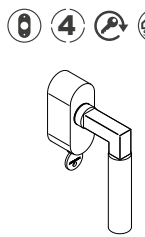
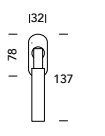
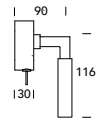
J04DKC80	Bezeichnung - Description	Farbe - Finishes	Alte Art.-Nr. - Old code	1 Stück - Piece
	Fensterolive "RC 2" zertifiziert Ros. 32x78 ohne Rastergehäuse (separat zu notieren*) DK with key RC2 certified on rose 32x78 without mechanism (to be ordered separately*)	Chrom - Polished chrome	402-C80-10E-000	1AJ04DKC800005XJA
		Schwarz RAL 9005 - Matt black RAL 9005	402-C80-10E-180	1AJ04DKC800018XJA
		Ultra Messing - PVD Gold	402-C80-10E-367	1AJ04DKC800046XJA
		Edelstahl - Stainless steel 304	402-C80-10E-057	1AJ04DKC800055XJA
		Nickel spiegelpol. Plus - Pol. Nickel Plus	402-C80-10E-004	1AJ04DKC8000K1XJA
	 Fensterolive "RC 2" zertifiziert Ros. 32x78 inklusive Rastergehäuse mit 30 mm vorstehendem Stift DK with key RC2 certified on rose 32x78 and 7x30 mm spindle (mechanism included)	Chrom - Polished chrome	402-C80-00E-000	1AJ04DKC803005XJA
		Schwarz RAL 9005 - Matt black RAL 9005	402-C80-00E-180	1AJ04DKC803018XJA
		Ultra Messing - PVD Gold	402-C80-00E-367	1AJ04DKC803046XJA
		Edelstahl - Stainless steel 304	402-C80-00E-057	1AJ04DKC803055XJA
		Nickel spiegelpol. Plus - Pol. Nickel Plus	402-C80-00E-004	1AJ04DKC8030K1XJA
 Fensterolive "RC 2" zertifiziert Ros. 32x78 inklusive Reastergehäuse mit 35 mm vorstehendem Stift DK with key RC2 certified on rose 32x78 and 7x35 mm spindle (mechanism included)	Chrom - Polished chrome	402-C80-20E-000	1AJ04DKC803505XJA	
	Schwarz RAL 9005 - Matt black RAL 9005	402-C80-20E-180	1AJ04DKC803518XJA	
	Ultra Messing - PVD Gold	402-C80-20E-367	1AJ04DKC803546XJA	
	Edelstahl - Stainless steel 304	402-C80-20E-057	1AJ04DKC803555XJA	
	Nickel spiegelpol. Plus - Pol. Nickel Plus	402-C80-20E-004	1AJ04DKC8035K1XJA	

*Rastergehäuse finden Sie auf Seite 172 / For mechanism please see page 172

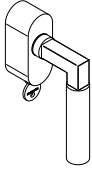
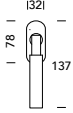
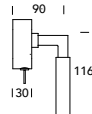
J04DKT80	Bezeichnung - Description	Farbe - Finishes	Alte Art.-Nr. - Old code	1 Stück - Piece
  	Fensterolive mit TBT Funktion Ros. 32x78 ohne Rastergehäuse (separat zu notieren*) <i>Dreh Kipp with key on rose 32x78 with TBT function without mechanism (to be ordered separately*)</i>	Chrom - Polished chrome	402-T80-10E-000	1AJ04DKT800005XJA
		Schwarz RAL 9005 - Matt black RAL 9005	402-T80-10E-180	1AJ04DKT800018XJA
		Ultra Messing - PVD Gold	402-T80-10E-367	1AJ04DKT800046XJA
		Edelstahl - Stainless steel 304	402-T80-10E-057	1AJ04DKT800055XJA
		Nickel spiegelpol. Plus - Pol. Nickel Plus	402-T80-10E-004	1AJ04DKT8000K1XJA
	Fensterolive mit TBT Funktion Ros. 32x78 inklusive Rastergehäuse mit 30 mm vorstehendem Stift <i>Dreh Kipp with key on rose 32x78 with TBT function and 7x30 mm spindle (mechanism included)</i>	Chrom - Polished chrome	402-T80-00E-000	1AJ04DKT803005XJA
		Schwarz RAL 9005 - Matt black RAL 9005	402-T80-00E-180	1AJ04DKT803018XJA
		Ultra Messing - PVD Gold	402-T80-00E-367	1AJ04DKT803046XJA
		Edelstahl - Stainless steel 304	402-T80-00E-057	1AJ04DKT803055XJA
		Nickel spiegelpol. Plus - Pol. Nickel Plus	402-T80-00E-004	1AJ04DKT8030K1XJA
	Fensterolive mit TBT Funktion Ros. 32x78 inklusive Reastergehäuse mit 35 mm vorstehendem Stift <i>Dreh Kipp with key on rose 32x78 with TBT function and 7x35 mm spindle (mechanism included)</i>	Chrom - Polished chrome	402-T80-20E-000	1AJ04DKT803505XJA
		Schwarz RAL 9005 - Matt black RAL 9005	402-T80-20E-180	1AJ04DKT803518XJA
Ultra Messing - PVD Gold		402-T80-20E-367	1AJ04DKT803546XJA	
Edelstahl - Stainless steel 304		402-T80-20E-057	1AJ04DKT803555XJA	
Nickel spiegelpol. Plus - Pol. Nickel Plus		402-T80-20E-004	1AJ04DKT8035K1XJA	

*Rastergehäuse finden Sie auf Seite 172 / For mechanism please see page 172

Belle Epoque J12

MESSING - BRASS

Datenblatt
Datasheet



05
Chrom
Polished chrome



46
Ultra Messing
PVD Gold



8B
Antik Nickel
Antique nickel

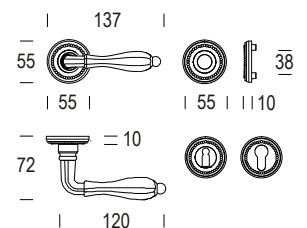

TÜRDRÜCKERGARNITUREN



J12MRJ13



J12MPJ12

WECHSELGARNITUREN



J12PMJ39



J12PMJ11

WC GARNITUREN



J12RJJ13



J12PJJ12

FENSTERGRIFFE



J12DKE69













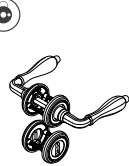



J12DKE70









J12DKC80





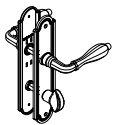

J12DKT80

J12MRJ13	Bezeichnung - Description	Farbe - Finishes	Alte Art.-Nr. - Old code	1 Stück - Piece
	Doppelte Bezeichnung Ø55x10 mm Schlüssellochung <i>Pair lever handle on rose Ø55x10 mm key hole</i>	Chrom - Polished chrome	933-984-A00-000	1AJ12MRJ133105EJA
		Ultra Messing - PVD Gold 	933-984-A00-367	1AJ12MRJ133146EJA
		Antik Nickel - Antique Nickel	933-984-A00-444	1AJ12MRJ13318BEJA
	Doppelte Bezeichnung Ø55x10 mm PZ <i>Pair lever handle on rose Ø55x10 mm euro profile cylinder hole</i>	Chrom - Polished chrome	933-984-B00-000	1AJ12MRJ133205EJA
		Ultra Messing - PVD Gold 	933-984-B00-367	1AJ12MRJ133246EJA
		Antik Nickel - Antique Nickel	933-984-B00-444	1AJ12MRJ13328BEJA
	WE-Garnitur mit Knopf J01 (420) PZ rechtszeigend <i>Entrance set lever handle / knob J01 (420) Euro profile cylinder hole (right hand)</i>	Chrom - Polished chrome	933-984-D00-000	1AJ12PMJ393205JJA
		Ultra Messing - PVD Gold 	933-984-D00-367	1AJ12PMJ393246JJA
		Antik Nickel - Antique Nickel	933-984-D00-444	1AJ12PMJ39328BJJA
	WE-Garnitur mit Knopf J01 (420) PZ linkszeigend <i>Entrance set lever handle / knob J01 (420) Euro profile cylinder hole (left hand)</i>	Chrom - Polished chrome	933-984-C00-000	1AJ12PMJ393205LJA
		Ultra Messing - PVD Gold 	933-984-C00-367	1AJ12PMJ393246LJA
		Antik Nickel - Antique Nickel	933-984-C00-444	1AJ12PMJ39328BLJA
	WC-Garnitur mit Rosetten Ø55x10 mm mit Riegel & Schlitzschraube 8mm VK <i>Pair lever handle on rose Ø55x10 mm with turn and release with 8 mm spindle</i>	Chrom - Polished chrome	933-984-E00-000	1AJ12RJJ134205EJA
		Ultra Messing - PVD Gold 	933-984-E00-367	1AJ12RJJ134246EJA
		Antik Nickel - Antique Nickel	933-984-E00-444	1AJ12RJJ13428BEJA
	ZT-Garnitur mit Schild 51x227 mm mit BB 72 mm <i>Pair lever handle on plate mm 51x227 with BB key hole 72mm</i>	Chrom - Polished chrome	933-983-100-000	1AJ12MPJ12B605XJA
		Ultra Messing - PVD Gold 	933-983-100-367	1AJ12MPJ12B646XJA
		Antik Nickel - Antique Nickel	933-983-100-444	1AJ12MPJ12B68BXJA
	ZT-Garnitur mit Schild 51x227 mm mit PZ 72 mm <i>Pair lever handle on plate mm 51x227 with Euro Profile cylinder hole 72mm</i>	Chrom - Polished chrome	933-983-200-000	1AJ12MPJ121305XJA
		Ultra Messing - PVD Gold 	933-983-200-367	1AJ12MPJ121346XJA
		Antik Nickel - Antique Nickel	933-983-200-444	1AJ12MPJ12138BXJA

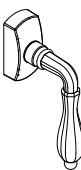
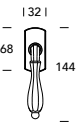
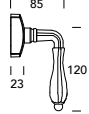
J12PMJ11	Bezeichnung - Description	Farbe - Finishes	Alte Art.-Nr. - Old code	1 Stück - Piece
	WE-Garnitur mit Knopf J02 (922) 72 mm PZ rechtszeigend <i>Entrance set lever handle / knob J02 (922) with Euro Profile cylinder hole 72mm (right hand)</i>	Chrom - Polished chrome	933-983-400-000	1AJ12PMJ111305JJA
		Ultra Messing - PVD Gold 	933-983-400-367	1AJ12PMJ111346JJA
		Antik Nickel - Antique Nickel	933-983-400-444	1AJ12PMJ11138BJJA
	WE-Garnitur mit Knopf J02 (922) 72 mm PZ linkszeigend <i>Entrance set lever handle / knob J02 (922) with Euro Profile cylinder hole 72mm (left hand)</i>	Chrom - Polished chrome	933-983-300-000	1AJ12PMJ111305LJA
		Ultra Messing - PVD Gold 	933-983-300-367	1AJ12PMJ111346LJA
		Antik Nickel - Antique Nickel	933-983-300-444	1AJ12PMJ11138BLJA
	WC-Garnitur 78 mm mit Schild 51x227mm mit Riegel & Schlitzschraube 8mm VK 8mm VK <i>Pair lever handle on plate mm51x227 with WC turn and release (8mm WC spindle) distance 78 mm (8mm WC spindle)</i>	Chrom - Polished chrome	933-983-600-000	1AJ12PJJ122405VJA
		Ultra Messing - PVD Gold 	933-983-600-367	1AJ12PJJ122446VJA
		Antik Nickel - Antique Nickel	933-983-600-444	1AJ12PJJ12248BVJA



FENSTERGRIFFE - WINDOW HANDLES

J12DKE69	Bezeichnung - Description	Farbe - Finishes	Alte Art.-Nr. - Old code	1 Stück - Piece
  	Fensterlive Ros. 33x69 ohne Rastergehäuse (separat zu notieren*) <i>Dreh Kipp on rose mm 33x69 without mechanism (to be ordered separately*)</i>	Chrom - Polished chrome	933-410-10E-000	1AJ12DKE690005XJA
		Ultra Messing - PVD Gold 	933-410-10E-367	1AJ12DKE690046XJA
		Antik Nickel - Antique Nickel	933-410-10E-444	1AJ12DKE69008BXJA
	Fensterlive Ros. 33x69 inklusive Rastergehäuse mit 30 mm vorstehendem Stift <i>Dreh Kipp on rose mm 33x69 and 7x30 mm spindle (mechanism included)</i>	Chrom - Polished chrome	933-410-00E-000	1AJ12DKE693005XJA
		Ultra Messing - PVD Gold 	933-410-00E-367	1AJ12DKE693046XJA
		Antik Nickel - Antique Nickel	933-410-00E-444	1AJ12DKE69308BXJA
	Fensterlive Ros. 33x69 inklusive Reastergehäuse mit 35 mm vorstehendem Stift <i>Dreh Kipp on rose mm 33x69 and 7x35 mm spindle (mechanism included)</i>	Chrom - Polished chrome	933-410-20E-000	1AJ12DKE693505XJA
		Ultra Messing - PVD Gold 	933-410-20E-367	1AJ12DKE693546XJA
		Antik Nickel - Antique Nickel	933-410-20E-444	1AJ12DKE69358BXJA

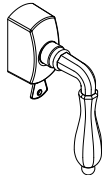
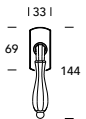
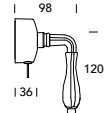
*Rastergehäuse finden Sie auf Seite 172 / For mechanism please see page 172

J12DKE70	Bezeichnung - Description	Farbe - Finishes	Alte Art.-Nr. - Old code	1 Stück - Piece
   	Fensterolive Ros. 33x69 abhließbar ohne Rastergehäuse (separat zu notieren*) Dreh Kipp with key on rose mm 33x69 without mechanism (to be ordered separately*)	Chrom - Polished chrome	933-310-10E-000	1AJ12DKE700005XJA
		Ultra Messing - PVD Gold	933-310-10E-367	1AJ12DKE700046XJA
		Antik Nickel - Antique Nickel	933-310-10E-444	1AJ12DKE70008BXJA
	Fensterolive Ros. 33x69 abhließbar inklusive Rastergehäuse mit 30 mm vorstehendem Stift Dreh Kipp with key on rose mm 33x69 and 7x30 mm spindle (mechanism included)	Chrom - Polished chrome	933-310-00E-000	1AJ12DKE703005XJA
		Ultra Messing - PVD Gold	933-310-00E-367	1AJ12DKE703046XJA
		Antik Nickel - Antique Nickel	933-310-00E-444	1AJ12DKE70308BXJA
	Fensterolive Ros. 33x69 abhließbar inklusive Rastergehäuse mit 35 mm vorstehendem Stift Dreh Kipp with key on rose mm 33x69 and 7x35 mm spindle (mechanism included)	Chrom - Polished chrome	933-310-20E-000	1AJ12DKE703505XJA
		Ultra Messing - PVD Gold	933-310-20E-367	1AJ12DKE703546XJA
		Antik Nickel - Antique Nickel	933-310-20E-444	1AJ12DKE70358BXJA

*Rastergehäuse finden Sie auf Seite 172 / For mechanism please see page 172

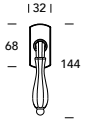
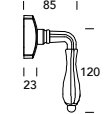
J12DKC80	Bezeichnung - Description	Farbe - Finishes	Alte Art.-Nr. - Old code	1 Stück - Piece
   	Fensterolive "RC 2" zertifiziert Ros. 32x78 ohne Rastergehäuse (separat zu notieren*) DK with key RC2 certified on rose 32x78 without mechanism (to be ordered separately*)	Chrom - Polished chrome	933-C80-10E-000	1AJ12DKC800005XJA
		Ultra Messing - PVD Gold	933-C80-10E-367	1AJ12DKC800046XJA
		Antik Nickel - Antique Nickel	933-C80-10E-444	1AJ12DKC80008BXJA
	Fensterolive "RC 2" zertifiziert Ros. 32x78 inklusive Rastergehäuse mit 30 mm vorstehendem Stift DK with key RC2 certified on rose 32x78 and 7x30 mm spindle (mechanism included)	Chrom - Polished chrome	933-C80-00E-000	1AJ12DKC803005XJA
		Ultra Messing - PVD Gold	933-C80-00E-367	1AJ12DKC803046XJA
		Antik Nickel - Antique Nickel	933-C80-00E-444	1AJ12DKC80308BXJA
	Fensterolive "RC 2" zertifiziert Ros. 32x78 inklusive Rastergehäuse mit 35 mm vorstehendem Stift DK with key RC2 certified on rose 32x78 and 7x35 mm spindle (mechanism included)	Chrom - Polished chrome	933-C80-20E-000	1AJ12DKC803505XJA
		Ultra Messing - PVD Gold	933-C80-20E-367	1AJ12DKC803546XJA
		Antik Nickel - Antique Nickel	933-C80-20E-444	1AJ12DKC80358BXJA

*Rastergehäuse finden Sie auf Seite 172 / For mechanism please see page 172

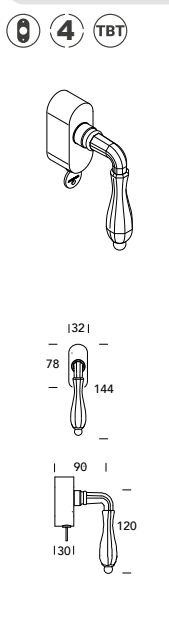
J12DKT80	Bezeichnung - Description	Farbe - Finishes	Alte Art.-Nr. - Old code	1 Stück - Piece
	Fensterolive mit TBT Funktion Ros. 32x78 ohne Rastergehäuse (separat zu notieren*) <i>Dreh Kipp with key on rose 32x78 with TBT function without mechanism (to be ordered separately*)</i>	Chrom - Polished chrome	933-T80-10E-000	1AJ12DKT800005XJA
		Ultra Messing - PVD Gold	933-T80-10E-367	1AJ12DKT800046XJA
		Antik Nickel - Antique Nickel	933-T80-10E-444	1AJ12DKT800088XJA
	Fensterolive mit TBT Funktion Ros. 32x78 inklusive Rastergehäuse mit 30 mm vorstehendem Stift <i>Dreh Kipp with key on rose 32x78 with TBT function and 7x30 mm spindle (mechanism included)</i>	Chrom - Polished chrome	933-T80-00E-000	1AJ12DKT803005XJA
		Ultra Messing - PVD Gold	933-T80-00E-367	1AJ12DKT803046XJA
		Antik Nickel - Antique Nickel	933-T80-00E-444	1AJ12DKT803088XJA
	Fensterolive mit TBT Funktion Ros. 32x78 inklusive Rastergehäuse mit 35 mm vorstehendem Stift <i>Dreh Kipp with key on rose 32x78 with TBT function and 7x35 mm spindle (mechanism included)</i>	Chrom - Polished chrome	933-T80-20E-000	1AJ12DKT803505XJA
		Ultra Messing - PVD Gold	933-T80-20E-367	1AJ12DKT803546XJA
		Antik Nickel - Antique Nickel	933-T80-20E-444	1AJ12DKT803588XJA

*Rastergehäuse finden Sie auf Seite 172 / For mechanism please see page 172

Belvedere J16

MESSING - BRASS

Datenblatt
Datasheet



46
Ultra Messing
PVD Gold

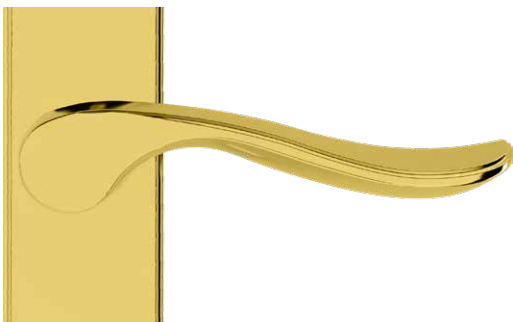

44 JATEC

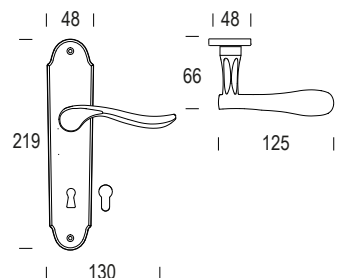

TÜRDRÜCKERGARNITUREN



J16MPJ16

WECHSELGARNITUREN



J16PMJ16

WC GARNITUREN



J16PJJ16

FENSTERGRIFFE



J16DKE66



J16DKC80



J16DKT80



J16TKE66



J16TKC80

SCHUTZGARNITUREN



J16TKT80











J16MAJ16



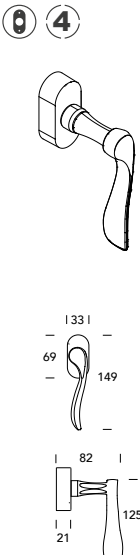





951GF913

Seite 222 / page 222

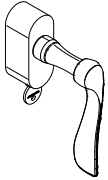
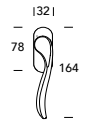
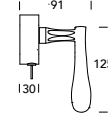





J16MPJ16	Bezeichnung - Description	Farbe - Finishes	Alte Art.-Nr. - Old code	1 Stück - Piece
	ZT-Garnitur mit Schild 44x220 mm mit BB 72 mm <i>Pair lever handle on plate mm 44x220 with BB key hole 72mm</i>	Ultra Messing - PVD Gold 	908-988-100-367	1AJ16MPJ16B646XJA
	ZT-Garnitur mit Schild 44x220 mm mit PZ 72 mm <i>Pair lever handle on plate mm 44x220 with Euro Profile cylinder hole 72mm</i>	Ultra Messing - PVD Gold 	908-988-200-367	1AJ16MPJ161346XJA
	WE-Garnitur mit Knopf J02 (922) 72 mm PZ rechtszeigend <i>Entrance set lever handle / knob J02 (922) with Euro Profile cylinder hole 72mm (right hand)</i>	Ultra Messing - PVD Gold 	908-988-400-367	1AJ16PMJ161346JJA
	WE-Garnitur mit Knopf J02 (922) 72 mm PZ linkszeigend <i>Entrance set lever handle / knob J02 (922) with Euro Profile cylinder hole 72mm (left hand)</i>	Ultra Messing - PVD Gold 	908-988-300-367	1AJ16PMJ161346LJA
	WC-Garnitur 78 mm mit Schild 44x220 mm mit Riegel & Schlitzschraube 8mm VK 8mm VK <i>Pair lever handle on plate mm44x220 with WC turn and release (8mm WC spindle) distance 78 mm (8mm WC spindle)</i>	Ultra Messing - PVD Gold 	908-988-600-367	1AJ16PJJ162446VJA

J16DKE66	Bezeichnung - Description	Farbe - Finishes	Alte Art.-Nr. - Old code	1 Stück - Piece
	<p>Fensterlive Ros. 33x69 ohne Rastergehäuse (separat zu notieren*)</p> <p><i>Dreh Kipp on rose mm 33x69 without mechanism (to be ordered separately*) (right hand)</i></p>	Ultra Messing - PVD Gold 	908-614-10E-367	1AJ16DKE660046DJA
	<p>Fensterlive Ros. 33x69 ohne Rastergehäuse (separat zu notieren*)</p> <p><i>Dreh Kipp on rose mm 33x69 without mechanism (to be ordered separately*) (left hand)</i></p>	Ultra Messing - PVD Gold 	908-613-10E-367	1AJ16DKE660046SJA
	<p>Fensterlive Ros. 33x69 inklusive Rastergehäuse mit 30 mm vorstehendem Stift</p> <p><i>Dreh Kipp on rose mm 33x69 and 7x30 mm spindle (mechanism included) (right hand)</i></p>	Ultra Messing - PVD Gold 	908-614-00E-367	1AJ16DKE663046DJA
	<p>Fensterlive Ros. 33x69 inklusive Rastergehäuse mit 30 mm vorstehendem Stift</p> <p><i>Dreh Kipp on rose mm 33x69 and 7x30 mm spindle (mechanism included) (left hand)</i></p>	Ultra Messing - PVD Gold 	908-613-00E-367	1AJ16DKE663046SJA
	<p>Fensterlive Ros. 33x69 inklusive Reastergehäuse mit 35 mm vorstehendem Stift</p> <p><i>Dreh Kipp on rose mm 33x69 and 7x35 mm spindle (mechanism included) (right hand)</i></p>	Ultra Messing - PVD Gold 	908-614-20E-367	1AJ16DKE663546DJA
	<p>Fensterlive Ros. 33x69 inklusive Reastergehäuse mit 35 mm vorstehendem Stift</p> <p><i>Dreh Kipp on rose mm 33x69 and 7x35 mm spindle (mechanism included) (left hand)</i></p>	Ultra Messing - PVD Gold 	908-613-20E-367	1AJ16DKE663546SJA

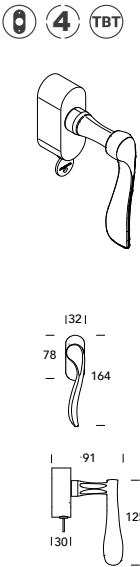
*Rastergehäuse finden Sie auf Seite 172 / For mechanism please see page 172

J16DKC80	Bezeichnung - Description	Farbe - Finishes	Alte Art.-Nr. - Old code	1 Stück - Piece
   	<p>Fensterolive "RC 2" zertifiziert Ros. 32x78 ohne Rastergehäuse (separat zu notieren*)</p> <p><i>DK with key RC2 certified on rose 32x78 without mechanism (to be ordered separately*) (right hand)</i></p>	Ultra Messing - PVD Gold 	908-C80-1RE-367	1AJ16DKC800046DJA
	<p>Fensterolive "RC 2" zertifiziert Ros. 32x78 ohne Rastergehäuse (separat zu notieren*)</p> <p><i>DK with key RC2 certified on rose 32x78 without mechanism (to be ordered separately*) (left hand)</i></p>	Ultra Messing - PVD Gold 	908-C80-1LE-367	1AJ16DKC800046SJA
	<p>Fensterolive "RC 2" zertifiziert Ros. 32x78 inklusive Rastergehäuse mit 30 mm vorstehendem Stift</p> <p><i>DK with key RC2 certified on rose 32x78 and 7x30 mm spindle (mechanism included) (right hand)</i></p>	Ultra Messing - PVD Gold 	908-C80-0RE-367	1AJ16DKC803046DJA
	<p>Fensterolive "RC 2" zertifiziert Ros. 32x78 inklusive Rastergehäuse mit 30 mm vorstehendem Stift</p> <p><i>DK with key RC2 certified on rose 32x78 and 7x30 mm spindle (mechanism included) (left hand)</i></p>	Ultra Messing - PVD Gold 	908-C80-0LE-367	1AJ16DKC803046SJA
	<p>Fensterolive "RC 2" zertifiziert Ros. 32x78 inklusive Rastergehäuse mit 35 mm vorstehendem Stift</p> <p><i>DK with key RC2 certified on rose 32x78 and 7x35 mm spindle (mechanism included) (right hand)</i></p>	Ultra Messing - PVD Gold 	908-C80-2RE-367	1AJ16DKC803546DJA
	<p>Fensterolive "RC 2" zertifiziert Ros. 32x78 inklusive Rastergehäuse mit 35 mm vorstehendem Stift</p> <p><i>DK with key RC2 certified on rose 32x78 and 7x35 mm spindle (mechanism included) (left hand)</i></p>	Ultra Messing - PVD Gold 	908-C80-2LE-367	1AJ16DKC803546SJA

*Rastergehäuse finden Sie auf Seite 172 / For mechanism please see page 172

J16DKT80	Bezeichnung - Description	Farbe - Finishes	Alte Art.-Nr. - Old code	1 Stück - Piece
	Fensterlive mit TBT Funktion Ros. 32x78 ohne Rastergehäuse (separat zu notieren*) <i>Dreh Kipp with key on rose 32x78 with TBT function without mechanism (to be ordered separately*) (right hand)</i>	Ultra Messing - PVD Gold 	908-T80-1RE-367	1AJ16DKT800046DJA
	Fensterlive mit TBT Funktion Ros. 32x78 ohne Rastergehäuse (separat zu notieren*) <i>Dreh Kipp with key on rose 32x78 with TBT function without mechanism (to be ordered separately*) (left hand)</i>	Ultra Messing - PVD Gold 	908-T80-1LE-367	1AJ16DKT800046SJA
	Fensterlive mit TBT Funktion Ros. 32x78 inklusive Rastergehäuse mit 30 mm vorstehendem Stift <i>Dreh Kipp with key on rose 32x78 with TBT function and 7x30 mm spindle (mechanism included) (right hand)</i>	Ultra Messing - PVD Gold 	908-T80-0RE-367	1AJ16DKT803046DJA
	Fensterlive mit TBT Funktion Ros. 32x78 inklusive Rastergehäuse mit 30 mm vorstehendem Stift <i>Dreh Kipp with key on rose 32x78 with TBT function and 7x30 mm spindle (mechanism included) (left hand)</i>	Ultra Messing - PVD Gold 	908-T80-0LE-367	1AJ16DKT803046SJA
	Fensterlive mit TBT Funktion Ros. 32x78 inklusive Reastergehäuse mit 35 mm vorstehendem Stift <i>Dreh Kipp with key on rose 32x78 with TBT function and 7x35 mm spindle (mechanism included) (right hand)</i>	Ultra Messing - PVD Gold 	908-T80-2RE-367	1AJ16DKT803546DJA
	Fensterlive mit TBT Funktion Ros. 32x78 inklusive Reastergehäuse mit 35 mm vorstehendem Stift <i>Dreh Kipp with key on rose 32x78 with TBT function and 7x35 mm spindle (mechanism included) (left hand)</i>	Ultra Messing - PVD Gold 	908-T80-2LE-367	1AJ16DKT803546SJA







*Rastergehäuse finden Sie auf Seite 172 / For mechanism please see page 172

J16TKE66	Bezeichnung - Description	Farbe - Finishes	Alte Art.-Nr. - Old code	1 Stück - Piece
	Fensterolive Ros. 33x69 ohne Rastergehäuse (separat zu notieren*) <i>TK Dreh Kipp T shape on rose mm 33x69 without mechanism (to be ordered separately*)</i>	Ultra Messing - PVD Gold	904-610-1TE-367	1AJ16TKE660046XJA
	Fensterolive Ros. 33x69 inklusive Rastergehäuse mit 30 mm vorstehendem Stift <i>TK Dreh Kipp T shape on rose mm 33x69 and 7x30 mm spindle (mechanism included)</i>	Ultra Messing - PVD Gold	904-610-0TE-367	1AJ16TKE663046XJA
	Fensterolive Ros. 33x69 inklusive Rastergehäuse mit 35 mm vorstehendem Stift <i>TK Dreh Kipp T shape on rose mm 33x69 and 7x35 mm spindle (mechanism included)</i>	Ultra Messing - PVD Gold	904-610-2TE-367	1AJ16TKE663546XJA

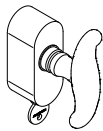
*Rastergehäuse finden Sie auf Seite 172 / For mechanism please see page 172

J16TKC80	Bezeichnung - Description	Farbe - Finishes	Alte Art.-Nr. - Old code	1 Stück - Piece
	Fensterolive "RC 2" zertifiziert Ros. 32x78 ohne Rastergehäuse (separat zu notieren*) <i>DK T shape with key RC2 certified on rose mm 32x78 without mechanism (to be ordered separately*)</i>	Ultra Messing - PVD Gold	904-C80-1TE-367	1AJ16TKC800046XJA
	Fensterolive "RC 2" zertifiziert Ros. 32x78 inklusive Rastergehäuse mit 30 mm vorstehendem Stift <i>DK T shape with key RC2 certified on rose mm 32x78 and 7x30 mm spindle (mechanism included)</i>	Ultra Messing - PVD Gold	904-C80-0TE-367	1AJ16TKC803046XJA
	Fensterolive "RC 2" zertifiziert Ros. 32x78 inklusive Rastergehäuse mit 35 mm vorstehendem Stift <i>DK T shape with key RC2 certified on rose mm 32x78 and 7x35 mm spindle (mechanism included)</i>	Ultra Messing - PVD Gold	904-C80-2TE-367	1AJ16TKC803546XJA

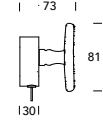
*Rastergehäuse finden Sie auf Seite 172 / For mechanism please see page 172

J16TKT80	Bezeichnung - Description	Farbe - Finishes	Alte Art.-Nr. - Old code	1 Stück - Piece
 	<p>Fensterolive mit TBT Funktion Ros. 32x78 ohne Rastergehäuse (separat zu notieren*)</p> <p><i>TK Dreh Kipp T shape with key on rose mm 32x78 with TBT function without mechanism (to be ordered separately*)</i></p>	Ultra Messing - PVD Gold 	904-T80-1TE-367	1AJ16TKT800046XJA
	<p>Fensterolive mit TBT Funktion Ros. 32x78 inklusive Rastergehäuse mit 30 mm vorstehendem Stift</p> <p><i>TK Dreh Kipp T shape with key on rose mm 32x78 with TBT function and 7x30 mm spindle (mechanism included)</i></p>	Ultra Messing - PVD Gold 	904-T80-0TE-367	1AJ16TKT803046XJA
	<p>Fensterolive mit TBT Funktion Ros. 32x78 inklusive Rastergehäuse mit 35 mm vorstehendem Stift</p> <p><i>TK Dreh Kipp T shape with key on rose mm 32x78 with TBT function and 7x35 mm spindle (mechanism included)</i></p>	Ultra Messing - PVD Gold 	904-T80-2TE-367	1AJ16TKT803546XJA

*Rastergehäuse finden Sie auf Seite 172 / For mechanism please see page 172

J16MAJ16	Bezeichnung - Description	Farbe - Finishes	Alte Art.-Nr. - Old code	1 Stück - Piece
  	<p>Fensterolive mit ovaler Rosette ohne Rasterung mit 7x30 mm Vorstehendem Stift</p> <p><i>Window handle without mechanism on oval rose with 7mm spindle</i></p>	Ultra Messing - PVD Gold 	904-000-000-367	1AJ16MAJ165146XJA

Escalier J03

MESSING - BRASS

Datenblatt
Datasheet



05
Chrom
Polished chrome



46
Ultra Messing
PVD Gold



8B
Antik Nickel
Antique nickel



98
Ultra Mattnickel
PVD Satin inox

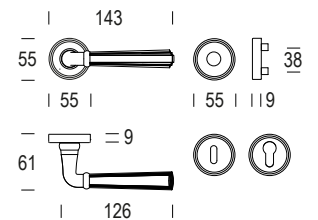
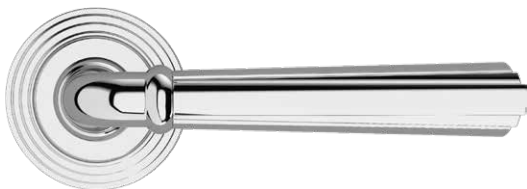

TÜRDRÜCKERGARNITUREN



J03MRJ03



J03MPJ03

WECHSELGARNITUREN



J03PMJ03



J03PMJ13

WC GARNITUREN



J03RJJ03



J03PJJ03

FENSTERGRIFFE



J03DKE66



J03DKE69



J03DKE70





J03DKC80

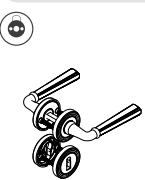
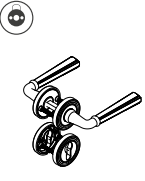
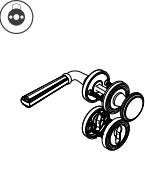
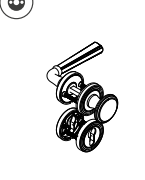
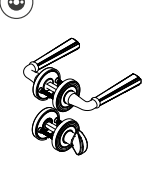
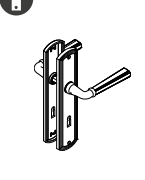
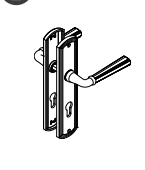

J03DKT80

J03MRJ03	Bezeichnung - Description	Farbe - Finishes	Alte Art.-Nr. - Old code	1 Stück - Piece
	Doppelte Bezeichnung Ø55x9 mm Schlüssellochung <i>Pair lever handle on rose Ø55x9 mm key hole</i>	Chrom - Polished chrome	900-993-A00-000	1AJ03MRJ033105EJA
		Ultra Messing - PVD Gold	900-993-A00-367	1AJ03MRJ033146EJA
		Antik Nickel - Antique Nickel	900-993-A00-444	1AJ03MRJ03318BEJA
		Ultra Mattnickel - PVD Satin inox	900-993-A00-066	1AJ03MRJ033198EJA
	Doppelte Bezeichnung Ø55x9 mm PZ <i>Pair lever handle on rose Ø55x9 mm euro profile cylinder hole</i>	Chrom - Polished chrome	900-993-B00-000	1AJ03MRJ033205EJA
		Ultra Messing - PVD Gold	900-993-B00-367	1AJ03MRJ033246EJA
		Antik Nickel - Antique Nickel	900-993-B00-444	1AJ03MRJ03328BEJA
		Ultra Mattnickel - PVD Satin inox	900-993-B00-066	1AJ03MRJ033298EJA
	WE-Garnitur mit Knopf J02 (922) PZ rechtszeigend <i>Entrance set lever handle / knob J02 (922) Euro profile cylinder hole (right hand)</i>	Chrom - Polished chrome	900-993-D00-000	1AJ03PMJ033205JJA
		Ultra Messing - PVD Gold	900-993-D00-367	1AJ03PMJ033246JJA
		Antik Nickel - Antique Nickel	900-993-D00-444	1AJ03PMJ03328BJJA
		Ultra Mattnickel - PVD Satin inox	900-993-D00-066	1AJ03PMJ033298JJA
	WE-Garnitur mit Knopf J02 (922) PZ linkszeigend <i>Entrance set lever handle / knob J02 (922) Euro profile cylinder hole (left hand)</i>	Chrom - Polished chrome	900-993-C00-000	1AJ03PMJ033205LJA
		Ultra Messing - PVD Gold	900-993-C00-367	1AJ03PMJ033246LJA
		Antik Nickel - Antique Nickel	900-993-C00-444	1AJ03PMJ03328BLJA
		Ultra Mattnickel - PVD Satin inox	900-993-C00-066	1AJ03PMJ033298LJA
	WC-Garnitur mit Rosetten Ø55x9 mm mit Riegel & Schlitzschraube 8mm VK <i>Pair lever handle on rose Ø55x9 mm with turn and release with 8 mm spindle</i>	Chrom - Polished chrome	900-993-E00-000	1AJ03RJJ034205EJA
		Ultra Messing - PVD Gold	900-993-E00-367	1AJ03RJJ034246EJA
		Antik Nickel - Antique Nickel	900-993-E00-444	1AJ03RJJ03428BEJA
		Ultra Mattnickel - PVD Satin inox	900-993-E00-066	1AJ03RJJ034298EJA
	ZT-Garnitur mit Schild 50x228 mm mit BB 72 mm <i>Pair lever handle on plate mm 50x228 with BB key hole 72mm</i>	Chrom - Polished chrome	900-959-100-000	1AJ03MPJ03B605XJA
		Ultra Messing - PVD Gold	900-959-100-367	1AJ03MPJ03B646XJA
		Antik Nickel - Antique Nickel	900-959-100-444	1AJ03MPJ03B68BXJA
		Ultra Mattnickel - PVD Satin inox	900-959-100-066	1AJ03MPJ03B698XJA
	ZT-Garnitur mit Schild 50x228 mm mit PZ 72 mm <i>Pair lever handle on plate mm 50x228 with Euro Profile cylinder hole 72mm</i>	Chrom - Polished chrome	900-959-200-000	1AJ03MPJ031305XJA
		Ultra Messing - PVD Gold	900-959-200-367	1AJ03MPJ031346XJA
		Antik Nickel - Antique Nickel	900-959-200-444	1AJ03MPJ03138BXJA
		Ultra Mattnickel - PVD Satin inox	900-959-200-066	1AJ03MPJ031398XJA

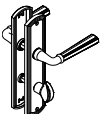
J03PMJ13	Bezeichnung - Description	Farbe - Finishes	Alte Art.-Nr. - Old code	1 Stück - Piece
	WE-Garnitur mit Knopf J02 (922) 72 mm PZ rechtszeigend <i>Entrance set lever handle / knob J02 (922) with Euro Profile cylinder hole 72mm (right hand)</i>	Chrom - Polished chrome	900-959-400-000	1AJ03PMJ131305JJA
		Ultra Messing - PVD Gold	900-959-400-367	1AJ03PMJ131346JJA
		Antik Nickel - Antique Nickel	900-959-400-444	1AJ03PMJ13138BJJA
		Ultra Mattnickel - PVD Satin inox	900-959-400-066	1AJ03PMJ131398JJA
	WE-Garnitur mit Knopf J02 (922) 72 mm PZ linkszeigend <i>Entrance set lever handle / knob J02 (922) with Euro Profile cylinder hole 72mm (left hand)</i>	Chrom - Polished chrome	900-959-300-000	1AJ03PMJ131305LJA
		Ultra Messing - PVD Gold	900-959-300-367	1AJ03PMJ131346LJA
		Antik Nickel - Antique Nickel	900-959-300-444	1AJ03PMJ13138BLJA
		Ultra Mattnickel - PVD Satin inox	900-959-300-066	1AJ03PMJ131398LJA
	WC-Garnitur 78 mm mit Schild 50x228 mm mit Riegel & Schlitzschraube 8mm VK 8mm VK <i>Pair lever handle on plate mm 50x228 with WC turn and release (8mm WC spindle) distance 78 mm (8mm WC spindle)</i>	Chrom - Polished chrome	900-959-600-000	1AJ03PJJ032405VJA
		Ultra Messing - PVD Gold	900-959-600-367	1AJ03PJJ032446VJA
		Antik Nickel - Antique Nickel	900-959-600-444	1AJ03PJJ03248BVJA
		Ultra Mattnickel - PVD Satin inox	900-959-600-066	1AJ03PJJ032498VJA

FENSTERGRIFFE - WINDOW HANDLES

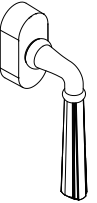
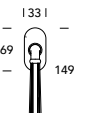
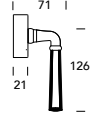
J03DKE66	Bezeichnung - Description	Farbe - Finishes	Alte Art.-Nr. - Old code	1 Stück - Piece
	Fensterolive Ros. 33x69 ohne Rastergehäuse (separat zu notieren*) <i>Dreh Kipp on rose mm 33x69 without mechanism (to be ordered separately*)</i>	Chrom - Polished chrome	900-510-10E-000	1AJ03DKE660005XJA
		Ultra Messing - PVD Gold	900-510-10E-367	1AJ03DKE660046XJA
		Antik Nickel - Antique Nickel	900-510-10E-444	1AJ03DKE66008BXJA
		Ultra Mattnickel - PVD Satin inox	900-510-10E-066	1AJ03DKE660098XJA
	Fensterolive Ros. 33x69 inklusive Rastergehäuse mit 30 mm vorstehendem Stift <i>Dreh Kipp on rose mm 33x69 and 7x30 mm spindle (mechanism included)</i>	Chrom - Polished chrome	900-510-00E-000	1AJ03DKE663005XJA
		Ultra Messing - PVD Gold	900-510-00E-367	1AJ03DKE663046XJA
		Antik Nickel - Antique Nickel	900-510-00E-444	1AJ03DKE66308BXJA
		Ultra Mattnickel - PVD Satin inox	900-510-00E-066	1AJ03DKE663098XJA
	Fensterolive Ros. 33x69 inklusive Rastergehäuse mit 35 mm vorstehendem Stift <i>Dreh Kipp on rose mm 33x69 and 7x35 mm spindle (mechanism included)</i>	Chrom - Polished chrome	900-510-20E-000	1AJ03DKE663505XJA
		Ultra Messing - PVD Gold	900-510-20E-367	1AJ03DKE663546XJA
		Antik Nickel - Antique Nickel	900-510-20E-444	1AJ03DKE66358BXJA
		Ultra Mattnickel - PVD Satin inox	900-510-20E-066	1AJ03DKE663598XJA

*Rastergehäuse finden Sie auf Seite 172 / For mechanism please see page 172

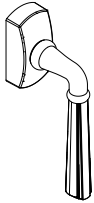
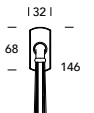
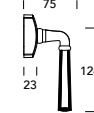
J03DKE69	Bezeichnung - Description	Farbe - Finishes	Alte Art.-Nr. - Old code	1 Stück - Piece
  	Fensterolive Ros. 33x69 ohne Rastergehäuse (separat zu notieren*) <i>Dreh Kipp on rose mm 33x69 without mechanism (to be ordered separately*)</i>	Chrom - Polished chrome	900-410-10E-000	1AJ03DKE690005XJA
		Ultra Messing - PVD Gold	900-410-10E-367	1AJ03DKE690046XJA
		Antik Nickel - Antique Nickel	900-410-10E-444	1AJ03DKE69008BXJA
		Ultra Mattnickel - PVD Satin inox	900-410-10E-066	1AJ03DKE690098XJA
	Fensterolive Ros. 33x69 inklusive Rastergehäuse mit 30 mm vorstehendem Stift <i>Dreh Kipp on rose mm 33x69 and 7x30 mm spindle (mechanism included)</i>	Chrom - Polished chrome	900-410-00E-000	1AJ03DKE693005XJA
		Ultra Messing - PVD Gold	900-410-00E-367	1AJ03DKE693046XJA
		Antik Nickel - Antique Nickel	900-410-00E-444	1AJ03DKE69308BXJA
		Ultra Mattnickel - PVD Satin inox	900-410-00E-066	1AJ03DKE693098XJA
	Fensterolive Ros. 33x69 inklusive Reastergehäuse mit 35 mm vorstehendem Stift <i>Dreh Kipp on rose mm 33x69 and 7x35 mm spindle (mechanism included)</i>	Chrom - Polished chrome	900-410-20E-000	1AJ03DKE693505XJA
		Ultra Messing - PVD Gold	900-410-20E-367	1AJ03DKE693546XJA
		Antik Nickel - Antique Nickel	900-410-20E-444	1AJ03DKE69358BXJA
		Ultra Mattnickel - PVD Satin inox	900-410-20E-066	1AJ03DKE693598XJA

*Rastergehäuse finden Sie auf Seite 172 / For mechanism please see page 172

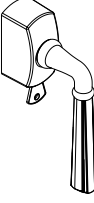
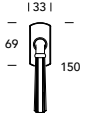
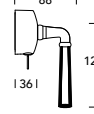
J03DKE70	Bezeichnung - Description	Farbe - Finishes	Alte Art.-Nr. - Old code	1 Stück - Piece
  	Fensterolive Ros. 33x69 abschließbar ohne Rastergehäuse (separat zu notieren*) <i>Dreh Kipp with key on rose mm 33x69 without mechanism (to be ordered separately*)</i>	Chrom - Polished chrome	900-310-10E-000	1AJ03DKE700005XJA
		Ultra Messing - PVD Gold	900-310-10E-367	1AJ03DKE700046XJA
		Antik Nickel - Antique Nickel	900-310-10E-444	1AJ03DKE70008BXJA
		Ultra Mattnickel - PVD Satin inox	900-310-10E-066	1AJ03DKE700098XJA
	Fensterolive Ros. 33x69 abschließbar inklusive Rastergehäuse mit 30 mm vorstehendem Stift <i>Dreh Kipp with key on rose mm 33x69 and 7x30 mm spindle (mechanism included)</i>	Chrom - Polished chrome	900-310-00E-000	1AJ03DKE703005XJA
		Ultra Messing - PVD Gold	900-310-00E-367	1AJ03DKE703046XJA
		Antik Nickel - Antique Nickel	900-310-00E-444	1AJ03DKE70308BXJA
		Ultra Mattnickel - PVD Satin inox	900-310-00E-066	1AJ03DKE703098XJA
	Fensterolive Ros. 33x69 abschließbar inklusive Reastergehäuse mit 35 mm vorstehendem Stift <i>Dreh Kipp with key on rose mm 33x69 and 7x35 mm spindle (mechanism included)</i>	Chrom - Polished chrome	900-310-20E-000	1AJ03DKE703505XJA
		Ultra Messing - PVD Gold	900-310-20E-367	1AJ03DKE703546XJA
		Antik Nickel - Antique Nickel	900-310-20E-444	1AJ03DKE70358BXJA
		Ultra Mattnickel - PVD Satin inox	900-310-20E-066	1AJ03DKE703598XJA

*Rastergehäuse finden Sie auf Seite 172 / For mechanism please see page 172

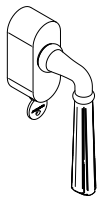
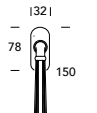
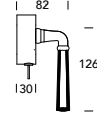
J03DKC80	Bezeichnung - Description	Farbe - Finishes	Alte Art.-Nr. - Old code	1 Stück - Piece
  	Fensterolive "RC 2" zertifiziert Ros. 32x78 ohne Rastergehäuse (separat zu notieren*) DK with key RC2 certified on rose 32x78 without mechanism (to be ordered separately*)	Chrom - Polished chrome	900-C80-10E-000	1AJ03DKC800005XJA
		Ultra Messing - PVD Gold	900-C80-10E-367	1AJ03DKC800046XJA
		Antik Nickel - Antique Nickel	900-C80-10E-444	1AJ03DKC80008BXJA
		Ultra Mattnickel - PVD Satin inox	900-C80-10E-066	1AJ03DKC800098XJA
	Fensterolive "RC 2" zertifiziert Ros. 32x78 inklusive Rastergehäuse mit 30 mm vorstehendem Stift DK with key RC2 certified on rose 32x78 and 7x30 mm spindle (mechanism included)	Chrom - Polished chrome	900-C80-00E-000	1AJ03DKC803005XJA
		Ultra Messing - PVD Gold	900-C80-00E-367	1AJ03DKC803046XJA
		Antik Nickel - Antique Nickel	900-C80-00E-444	1AJ03DKC80308BXJA
		Ultra Mattnickel - PVD Satin inox	900-C80-00E-066	1AJ03DKC803098XJA
	Fensterolive "RC 2" zertifiziert Ros. 32x78 inklusive Rastergehäuse mit 35 mm vorstehendem Stift DK with key RC2 certified on rose 32x78 and 7x35 mm spindle (mechanism included)	Chrom - Polished chrome	900-C80-20E-000	1AJ03DKC803505XJA
		Ultra Messing - PVD Gold	900-C80-20E-367	1AJ03DKC803546XJA
		Antik Nickel - Antique Nickel	900-C80-20E-444	1AJ03DKC80358BXJA
		Ultra Mattnickel - PVD Satin inox	900-C80-20E-066	1AJ03DKC803598XJA

*Rastergehäuse finden Sie auf Seite 172 / For mechanism please see page 172

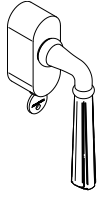
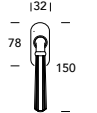
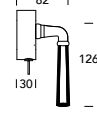
J03DKT80	Bezeichnung - Description	Farbe - Finishes	Alte Art.-Nr. - Old code	1 Stück - Piece
  	Fensterolive mit TBT Funktion Ros. 32x78 ohne Rastergehäuse (separat zu notieren*) Dreh Kipp with key on rose 32x78 with TBT function without mechanism (to be ordered separately*)	Chrom - Polished chrome	900-T80-10E-000	1AJ03DKT800005XJA
		Ultra Messing - PVD Gold	900-T80-10E-367	1AJ03DKT800046XJA
		Antik Nickel - Antique Nickel	900-T80-10E-444	1AJ03DKT80008BXJA
		Ultra Mattnickel - PVD Satin inox	900-T80-10E-066	1AJ03DKT800098XJA
	Fensterolive mit TBT Funktion Ros. 32x78 inklusive Rastergehäuse mit 30 mm vorstehendem Stift Dreh Kipp with key on rose 32x78 with TBT function and 7x30 mm spindle (mechanism included)	Chrom - Polished chrome	900-T80-00E-000	1AJ03DKT803005XJA
		Ultra Messing - PVD Gold	900-T80-00E-367	1AJ03DKT803046XJA
		Antik Nickel - Antique Nickel	900-T80-00E-444	1AJ03DKT80308BXJA
		Ultra Mattnickel - PVD Satin inox	900-T80-00E-066	1AJ03DKT803098XJA
	Fensterolive mit TBT Funktion Ros. 32x78 inklusive Rastergehäuse mit 35 mm vorstehendem Stift Dreh Kipp with key on rose 32x78 with TBT function and 7x35 mm spindle (mechanism included)	Chrom - Polished chrome	900-T80-20E-000	1AJ03DKT803505XJA
		Ultra Messing - PVD Gold	900-T80-20E-367	1AJ03DKT803546XJA
		Antik Nickel - Antique Nickel	900-T80-20E-444	1AJ03DKT80358BXJA
		Ultra Mattnickel - PVD Satin inox	900-T80-20E-066	1AJ03DKT803598XJA

*Rastergehäuse finden Sie auf Seite 172 / For mechanism please see page 172



18
Schwarz RAL 9005
Matt black RAL 9005



98
Ultra Mattnickel
PVD Satin inox

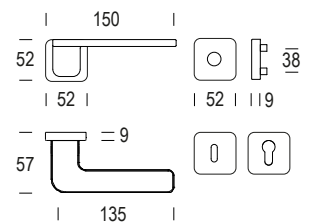

TÜRDRÜCKERGARNITUREN



J20MRJ37

WECHSELGARNITUREN











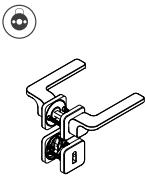

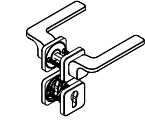
J20PMJ38

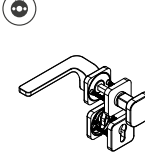
WC GARNITUREN

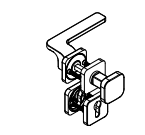

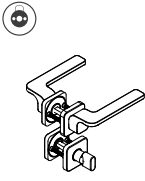
J20JRJ37

J20MRJ37	Bezeichnung - Description	Farbe - Finishes	Alte Art.-Nr. - Old code	1 Stück - Piece
	Doppelte Bezeichnung 52x52x9 mm Schlüssellochung <i>Pair lever handle on rose 52x52x9 mm key hole</i>	Schwarz RAL 9005 - Matt black RAL 9005	381-388-A00-180	1AJ20MRJ373118EJA
		Ultra Mattnickel - PVD Satin inox 	381-388-A00-066	1AJ20MRJ373198EJA
	Doppelte Bezeichnung 52x52x9 mm PZ <i>Pair lever handle on rose 52x52x9 mm euro profile cylinder hole</i>	Schwarz RAL 9005 - Matt black RAL 9005	381-388-B00-180	1AJ20MRJ373218EJA
		Ultra Mattnickel - PVD Satin inox 	381-388-B00-066	1AJ20MRJ373298EJA
	WE-Garnitur mit Knopf J37 (375) PZ rechtszeigend <i>Entrance set lever handle / knob J37 (375) Euro profile cylinder hole (right hand)</i>	Schwarz RAL 9005 - Matt black RAL 9005	381-388-D00-180	1AJ20PMJ383218JJA
		Ultra Mattnickel - PVD Satin inox 	381-388-D00-066	1AJ20PMJ383298JJA
	WE-Garnitur mit Knopf J37 (375) PZ linkszeigend <i>Entrance set lever handle / knob J37 (375) Euro profile cylinder hole (left hand)</i>	Schwarz RAL 9005 - Matt black RAL 9005	381-388-C00-180	1AJ20PMJ383218LJA
		Ultra Mattnickel - PVD Satin inox 	381-388-C00-066	1AJ20PMJ383298LJA
	WC-Garnitur mit Rosetten 52x52x9 mm mit Riegel & Schlitzschraube <i>Pair lever handle on rose 52x52x9 mm with turn and release</i>	Schwarz RAL 9005 - Matt black RAL 9005	381-388-E00-180	1AJ20JRJ374218EJA
		Ultra Mattnickel - PVD Satin inox 	381-388-E00-066	1AJ20JRJ374298EJA



ID-9 Eckig J37

MESSING - BRASS

Datenblatt
Datasheet



reddot design award



DESIGN BY ARTEFAKT



05
Chrom
Polished chrome



18
Schwarz RAL 9005
Matt black RAL 9005



5S
Edelstahl
Stainless steel 304

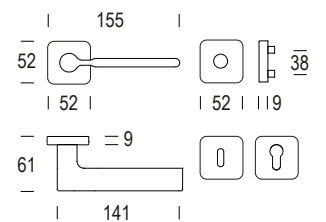

TÜRDRÜCKERGARNITUREN



J37MRJ37

WECHSELGARNITUREN



J37PMJ38

WC GARNITUREN

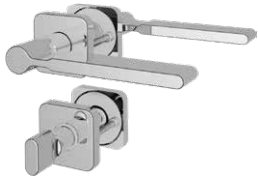

J37JRJ37

FENSTERGRIFFE



J37DKE69



J37DKE70

SCHUTZGARNITUREN



973GF374

Seite 208 / page 208

J37MRJ37	Bezeichnung - Description	Farbe - Finishes	Alte Art.-Nr. - Old code	1 Stück - Piece
	Doppelte Bezeichnung 52x52x9 mm Schlüssellochung <i>Pair lever handle on rose 52x52x9 mm key hole</i>	Chrom - Polished chrome	377-388-A00-000	1AJ37MRJ373105EJA
		Schwarz RAL 9005 - Matt black RAL 9005	377-388-A00-180	1AJ37MRJ373118EJA
		Edelstahl - Stainless steel 304	377-388-A00-055	1AJ37MRJ373155EJA
	Doppelte Bezeichnung 52x52x9 mm PZ <i>Pair lever handle on rose 52x52x9 mm euro profile cylinder hole</i>	Chrom - Polished chrome	377-388-B00-000	1AJ37MRJ373205EJA
		Schwarz RAL 9005 - Matt black RAL 9005	377-388-B00-180	1AJ37MRJ373218EJA
		Edelstahl - Stainless steel 304	377-388-B00-055	1AJ37MRJ373255EJA
	WE-Garnitur mit Knopf J37 (375) PZ rechtszeigend <i>Entrance set lever handle / knob J37 (375) Euro profile cylinder hole (right hand)</i>	Chrom - Polished chrome	377-388-D00-000	1AJ37PMJ383205JJA
		Schwarz RAL 9005 - Matt black RAL 9005	377-388-D00-180	1AJ37PMJ383218JJA
		Edelstahl - Stainless steel 304	377-388-D00-057	1AJ37PMJ383255JJA
	WE-Garnitur mit Knopf J37 (375) PZ linkszeigend <i>Entrance set lever handle / knob J37 (375) Euro profile cylinder hole (left hand)</i>	Chrom - Polished chrome	377-388-C00-000	1AJ37PMJ383205LJA
		Schwarz RAL 9005 - Matt black RAL 9005	377-388-C00-180	1AJ37PMJ383218LJA
		Edelstahl - Stainless steel 304	377-388-C00-057	1AJ37PMJ383255LJA
	WC-Garnitur mit Rosetten 52x52x9 mm mit Riegel & Schlitzschraube <i>Pair lever handle on rose 52x52x9 mm with turn and release</i>	Chrom - Polished chrome	377-388-E00-000	1AJ37JRJ374205EJA
		Schwarz RAL 9005 - Matt black RAL 9005	377-388-E00-180	1AJ37JRJ374218EJA
		Edelstahl - Stainless steel 304	377-388-E00-057	1AJ37JRJ374255EJA

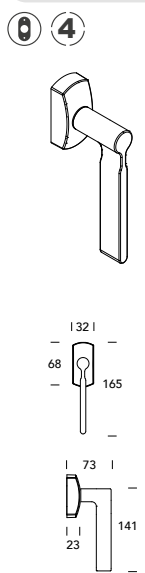
J37DKE69	Bezeichnung - Description	Farbe - Finishes	Alte Art.-Nr. - Old code	1 Stück - Piece
	Fensterlive Ros. 33x69 ohne Rastergehäuse (separat zu notieren*) <i>Dreh Kipp on rose mm 33x69 without mechanism (to be ordered separately*)</i>	Chrom - Polished chrome	377-410-10E-000	1AJ37DKE690005XJA
		Schwarz RAL 9005 - Matt black RAL 9005	377-410-10E-180	1AJ37DKE690018XJA
		Edelstahl - Stainless steel 304	377-410-10E-057	1AJ37DKE69005SXJA
	Fensterlive Ros. 33x69 inklusive Rastergehäuse mit 30 mm vorstehendem Stift <i>Dreh Kipp on rose mm 33x69 and 7x30 mm spindle (mechanism included)</i>	Chrom - Polished chrome	377-410-00E-000	1AJ37DKE693005XJA
		Schwarz RAL 9005 - Matt black RAL 9005	377-410-00E-180	1AJ37DKE693018XJA
		Edelstahl - Stainless steel 304	377-410-00E-057	1AJ37DKE69305SXJA
	Fensterlive Ros. 33x69 inklusive Reastergehäuse mit 35 mm vorstehendem Stift <i>Dreh Kipp on rose mm 33x69 and 7x35 mm spindle (mechanism included)</i>	Chrom - Polished chrome	377-410-20E-000	1AJ37DKE693505XJA
		Schwarz RAL 9005 - Matt black RAL 9005	377-410-20E-180	1AJ37DKE693518XJA
		Edelstahl - Stainless steel 304	377-410-20E-057	1AJ37DKE69355SXJA

*Rastergehäuse finden Sie auf Seite 172 / For mechanism please see page 172

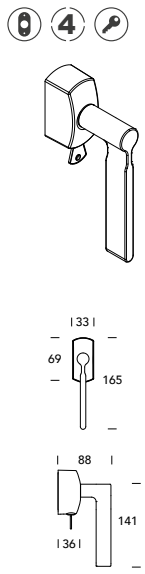
J37DKE70	Bezeichnung - Description	Farbe - Finishes	Alte Art.-Nr. - Old code	1 Stück - Piece
	Fensterlive Ros. 33x69 abschließbar ohne Rastergehäuse (separat zu notieren*) <i>Dreh Kipp with key on rose mm 33x69 without mechanism (to be ordered separately*)</i>	Chrom - Polished chrome	377-310-10E-000	1AJ37DKE700005XJA
		Schwarz RAL 9005 - Matt black RAL 9005	377-310-10E-180	1AJ37DKE700018XJA
		Edelstahl - Stainless steel 304	377-310-10E-057	1AJ37DKE70005SXJA
	Fensterlive Ros. 33x69 abschließbar inklusive Rastergehäuse mit 30 mm vorstehendem Stift <i>Dreh Kipp with key on rose mm 33x69 and 7x30 mm spindle (mechanism included)</i>	Chrom - Polished chrome	377-310-00E-000	1AJ37DKE703005XJA
		Schwarz RAL 9005 - Matt black RAL 9005	377-310-00E-180	1AJ37DKE703018XJA
		Edelstahl - Stainless steel 304	377-310-00E-057	1AJ37DKE70305SXJA
	Fensterlive Ros. 33x69 abschließbar inklusive Reastergehäuse mit 35 mm vorstehendem Stift <i>Dreh Kipp with key on rose mm 33x69 and 7x35 mm spindle (mechanism included)</i>	Chrom - Polished chrome	377-310-20E-000	1AJ37DKE703505XJA
		Schwarz RAL 9005 - Matt black RAL 9005	377-310-20E-180	1AJ37DKE703518XJA
		Edelstahl - Stainless steel 304	377-310-20E-057	1AJ37DKE70355SXJA

*Rastergehäuse finden Sie auf Seite 172 / For mechanism please see page 172

ID-9 Rund J37

MESSING - BRASS

Datenblatt
Datasheet



red dot design award



DESIGN BY ARTEFAKT



05
Chrom
Polished chrome



18
Schwarz RAL 9005
Matt black RAL 9005



5S
Edelstahl
Stainless steel 304

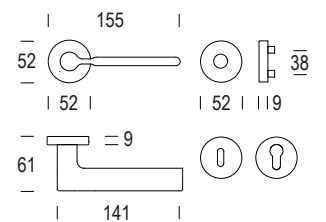

TÜRDRÜCKERGARNITUREN



J37MRJ01

WECHSELGARNITUREN



J37PMJ20 *

WC GARNITUREN



J37JRJ01

FENSTERGRIFFE



J37DKE66



J37DKC80





J37DKT80

J37MRJ01	Bezeichnung - Description	Farbe - Finishes	Alte Art.-Nr. - Old code	1 Stück - Piece
	Doppelte Bezeichnung Ø52x9 mm Schlüssellochung Pair lever handle on rose Ø52x9 mm key hole	Chrom - Polished chrome	377-373-A00-000	1AJ37MRJ013105EJA
		Schwarz RAL 9005 - Matt black RAL 9005	377-373-A00-180	1AJ37MRJ013118EJA
		Edelstahl - Stainless steel 304	377-373-A00-055	1AJ37MRJ01315SEJA
	Doppelte Bezeichnung Ø52x9 mm PZ Pair lever handle on rose Ø52x9 mm euro profile cylinder hole	Chrom - Polished chrome	377-373-B00-000	1AJ37MRJ013205EJA
		Schwarz RAL 9005 - Matt black RAL 9005	377-373-B00-180	1AJ37MRJ013218EJA
		Edelstahl - Stainless steel 304	377-373-B00-055	1AJ37MRJ01325SEJA
	WE-Garnitur mit Knopf J01 (420) PZ rechtszeigend Entrance set lever handle / knob J01 (420) Euro profile cylinder hole (right hand)	Chrom - Polished chrome	377-373-D00-000	1AJ37PMJ203205JJA
		Schwarz RAL 9005 - Matt black RAL 9005	377-373-D00-180	1AJ37PMJ203218JJA
		Edelstahl - Stainless steel 304	377-373-D00-057	1AJ37PMJ20325SJJJA
	WE-Garnitur mit Knopf J01 (420) PZ linkszeigend Entrance set lever handle / knob J01 (420) Euro profile cylinder hole (left hand)	Chrom - Polished chrome	377-373-C00-000	1AJ37PMJ203205LJA
		Schwarz RAL 9005 - Matt black RAL 9005	377-373-C00-180	1AJ37PMJ203218LJA
		Edelstahl - Stainless steel 304	377-373-C00-057	1AJ37PMJ20325SLJA
	WC-Garnitur mit Rosetten Ø52x9 mm mit Riegel & Schlitzschraube Pair lever handle on rose Ø52x9 mm with turn and release	Chrom - Polished chrome	377-373-E00-000	1AJ37JRJ014205EJA
		Schwarz RAL 9005 - Matt black RAL 9005	377-373-E00-180	1AJ37JRJ014218EJA
		Edelstahl - Stainless steel 304	377-373-E00-057	1AJ37JRJ01425SEJA

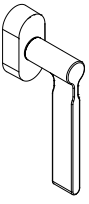
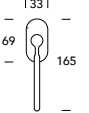
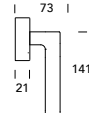

FENSTERGRIFFE - WINDOW HANDLES

J37DKE66	Bezeichnung - Description	Farbe - Finishes	Alte Art.-Nr. - Old code	1 Stück - Piece
	Fensterlive Ros. 33x69 ohne Rastergehäuse (separat zu notieren*) Dreh Kipp on rose mm 33x69 without mechanism (to be ordered separately*)	Chrom - Polished chrome	377-510-10E-000	1AJ37DKE660005XJA
		Schwarz RAL 9005 - Matt black RAL 9005	377-510-10E-180	1AJ37DKE660018XJA
		Edelstahl - Stainless steel 304	377-510-10E-057	1AJ37DKE66005SXJA
	Fensterlive Ros. 33x69 inklusive Rastergehäuse mit 30 mm vorstehendem Stift Dreh Kipp on rose mm 33x69 and 7x30 mm spindle (mechanism included)	Chrom - Polished chrome	377-510-00E-000	1AJ37DKE663005XJA
		Schwarz RAL 9005 - Matt black RAL 9005	377-510-00E-180	1AJ37DKE663018XJA
		Edelstahl - Stainless steel 304	377-510-00E-057	1AJ37DKE66305SXJA
	Fensterlive Ros. 33x69 inklusive Rastergehäuse mit 35 mm vorstehendem Stift Dreh Kipp on rose mm 33x69 and 7x35 mm spindle (mechanism included)	Chrom - Polished chrome	377-510-20E-000	1AJ37DKE663505XJA
		Schwarz RAL 9005 - Matt black RAL 9005	377-510-20E-180	1AJ37DKE663518XJA
		Edelstahl - Stainless steel 304	377-510-20E-057	1AJ37DKE66355SXJA

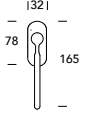
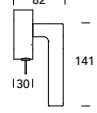
*Rastergehäuse finden Sie auf Seite 172 / For mechanism please see page 172

J37DKC80		Bezeichnung - Description	Farbe - Finishes	Alte Art.-Nr. - Old code	1 Stück - Piece
   	Fensterolive "RC 2" zertifiziert Ros. 32x78 ohne Rastergehäuse (separat zu notieren*) <i>DK with key RC2 certified on rose 32x78 without mechanism (to be ordered separately*)</i>	Chrom - Polished chrome	377-C80-10E-000	1AJ37DKC800005XJA	
		Schwarz RAL 9005 - Matt black RAL 9005	377-C80-10E-180	1AJ37DKC800018XJA	
		Edelstahl - Stainless steel 304	377-C80-10E-055	1AJ37DKC800055XJA	
	Fensterolive "RC 2" zertifiziert Ros. 32x78 inklusive Rastergehäuse mit 30 mm vorstehendem Stift <i>DK with key RC2 certified on rose 32x78 and 7x30 mm spindle (mechanism included)</i>	Chrom - Polished chrome	377-C80-00E-000	1AJ37DKC803005XJA	
		Schwarz RAL 9005 - Matt black RAL 9005	377-C80-00E-180	1AJ37DKC803018XJA	
		Edelstahl - Stainless steel 304	377-C80-00E-055	1AJ37DKC803055XJA	
	Fensterolive "RC 2" zertifiziert Ros. 32x78 inklusive Reastergehäuse mit 35 mm vorstehendem Stift <i>DK with key RC2 certified on rose 32x78 and 7x35 mm spindle (mechanism included)</i>	Chrom - Polished chrome	377-C80-20E-000	1AJ37DKC803505XJA	
		Schwarz RAL 9005 - Matt black RAL 9005	377-C80-20E-180	1AJ37DKC803518XJA	
		Edelstahl - Stainless steel 304	377-C80-20E-055	1AJ37DKC803555XJA	

*Rastergehäuse finden Sie auf Seite 172 / For mechanism please see page 172

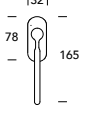
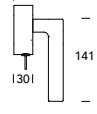
J37DKT80		Bezeichnung - Description	Farbe - Finishes	Alte Art.-Nr. - Old code	1 Stück - Piece
   	Fensterolive mit TBT Funktion Ros. 32x78 ohne Rastergehäuse (separat zu notieren*) <i>Dreh Kipp with key on rose 32x78 with TBT function without mechanism (to be ordered separately*)</i>	Chrom - Polished chrome	377-T80-10E-000	1AJ37DKT800005XJA	
		Schwarz RAL 9005 - Matt black RAL 9005	377-T80-10E-180	1AJ37DKT800018XJA	
		Edelstahl - Stainless steel 304	377-T80-10E-055	1AJ37DKT800055XJA	
	Fensterolive mit TBT Funktion Ros. 32x78 inklusive Rastergehäuse mit 30 mm vorstehendem Stift <i>Dreh Kipp with key on rose 32x78 with TBT function and 7x30 mm spindle (mechanism included)</i>	Chrom - Polished chrome	377-T80-00E-000	1AJ37DKT803005XJA	
		Schwarz RAL 9005 - Matt black RAL 9005	377-T80-00E-180	1AJ37DKT803018XJA	
		Edelstahl - Stainless steel 304	377-T80-00E-055	1AJ37DKT803055XJA	
	Fensterolive mit TBT Funktion Ros. 32x78 inklusive Reastergehäuse mit 35 mm vorstehendem Stift <i>Dreh Kipp with key on rose 32x78 with TBT function and 7x35 mm spindle (mechanism included)</i>	Chrom - Polished chrome	377-T80-20E-000	1AJ37DKT803505XJA	
		Schwarz RAL 9005 - Matt black RAL 9005	377-T80-20E-180	1AJ37DKT803518XJA	
		Edelstahl - Stainless steel 304	377-T80-20E-055	1AJ37DKT803555XJA	

*Rastergehäuse finden Sie auf Seite 172 / For mechanism please see page 172

IQ-Carre J27

MESSING - BRASS

Datenblatt
Datasheet



DESIGN BY MATTEO THUN



05
Chrom
Polished chrome



18
Schwarz RAL 9005
Matt black RAL 9005

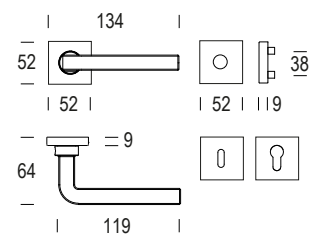
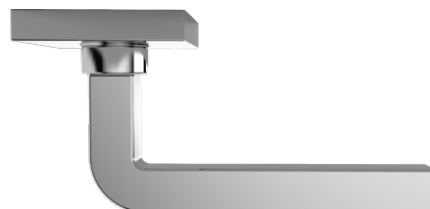
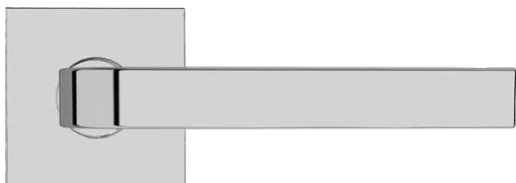

TÜRDRÜCKERGARNITUREN



J27MRJ30



J27MPJ04

WECHSELGARNITUREN



J27PMJ30



J27PMJ33

SCHUTZGARNITUREN



973GF373
Seite 206 / page 206

WC GARNITUREN

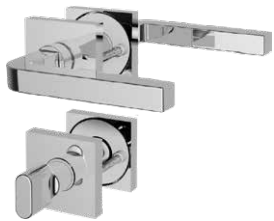

J27JRJ30



J27JPJ04

FENSTERGRIFFE



J27DKE69



J27DKE70



J27DKC81



J27DKT81



J27DKE82



130TKC81 *









130TKE82 *



J27SEJ06



130MAJQ6 *

J27MRJ30	Bezeichnung - Description	Farbe - Finishes	Alte Art.-Nr. - Old code	1 Stück - Piece
	Doppelte Bezeichnung 52x52x9 mm Schlüssellochung <i>Pair lever handle on rose 52x52x9 mm key hole</i>	Chrom - Polished chrome	373-371-A00-000	1AJ27MRJ303105EJA
		Schwarz RAL 9005 - Matt black RAL 9005	373-371-A00-180	1AJ27MRJ303118EJA
	Doppelte Bezeichnung 52x52x9 mm PZ <i>Pair lever handle on rose 52x52x9 mm euro profile cylinder hole</i>	Chrom - Polished chrome	373-371-B00-000	1AJ27MRJ303205EJA
		Schwarz RAL 9005 - Matt black RAL 9005	373-371-B00-180	1AJ27MRJ303218EJA
J27PMJ30	Bezeichnung - Description	Farbe - Finishes	Alte Art.-Nr. - Old code	1 Stück - Piece
	WE-Garnitur mit Knopf J03 (373) PZ rechtszeigend <i>Entrance set lever handle / knob J03 (373) Euro profile cylinder hole (right hand)</i>	Chrom - Polished chrome	373-371-D00-000	1AJ27PMJ303205JJA
		Schwarz RAL 9005 - Matt black RAL 9005	373-371-D00-180	1AJ27PMJ303218JJA
	WE-Garnitur mit Knopf J03 (373) PZ linkszeigend <i>Entrance set lever handle / knob J03 (373) Euro profile cylinder hole (left hand)</i>	Chrom - Polished chrome	373-371-C00-000	1AJ27PMJ303205LJA
		Schwarz RAL 9005 - Matt black RAL 9005	373-371-C00-180	1AJ27PMJ303218LJA
J27JRJ30	Bezeichnung - Description	Farbe - Finishes	Alte Art.-Nr. - Old code	1 Stück - Piece
	WC-Garnitur mit Rosetten 52x52x9 mm mit Riegel & Schlitzschraube <i>Pair lever handle on rose 52x52x9 mm with turn and release</i>	Chrom - Polished chrome	373-371-E00-000	1AJ27JRJ304205EJA
		Schwarz RAL 9005 - Matt black RAL 9005	373-371-E00-180	1AJ27JRJ304218EJA
J27MPJ04	Bezeichnung - Description	Farbe - Finishes	Alte Art.-Nr. - Old code	1 Stück - Piece
	ZT-Garnitur mit Schild 48x236 mm mit BB 72 mm <i>Pair lever handle on plate mm 48x236 with BB key hole 72mm</i>	Chrom - Polished chrome	373-964-100-000	1AJ27MPJ04B605XJA
		Schwarz RAL 9005 - Matt black RAL 9005	373-964-100-180	1AJ27MPJ04B618XJA
	ZT-Garnitur mit Schild 48x236 mm mit PZ 72 mm <i>Pair lever handle on plate mm 48x236 with Euro Profile cylinder hole 72mm</i>	Chrom - Polished chrome	373-964-200-000	1AJ27MPJ041305XJA
		Schwarz RAL 9005 - Matt black RAL 9005	373-964-200-180	1AJ27MPJ041318XJA

J27PMJ33	Bezeichnung - Description	Farbe - Finishes	Alte Art.-Nr. - Old code	1 Stück - Piece
	WE-Garnitur mit Knopf J03 (373) 72 mm PZ rechtszeigend <i>Entrance set lever handle / knob J03 (373) with Euro Profile cylinder hole 72mm (right hand)</i>	Chrom - Polished chrome	373-964-400-000	1AJ27PMJ331305JJA
		Schwarz RAL 9005 - Matt black RAL 9005	373-964-400-180	1AJ27PMJ331318JJA
	WE-Garnitur mit Knopf J03 (373) 72 mm PZ linkszeigend <i>Entrance set lever handle / knob J03 (373) with Euro Profile cylinder hole 72mm (left hand)</i>	Chrom - Polished chrome	373-964-300-000	1AJ27PMJ331305LJA
		Schwarz RAL 9005 - Matt black RAL 9005	373-964-300-180	1AJ27PMJ331318LJA
J27JPJ04	Bezeichnung - Description	Farbe - Finishes	Alte Art.-Nr. - Old code	1 Stück - Piece
	WC-Garnitur 78 mm mit Schild 48x236 mm mit Riegel & Schlitzschraube <i>Pair lever handle on plate mm 48x236 with WC turn and release distance 78 mm</i>	Chrom - Polished chrome	373-964-600-000	1AJ27JPJ042405VJA
		Schwarz RAL 9005 - Matt black RAL 9005	373-964-600-180	1AJ27JPJ042418VJA

FENSTERGRIFFE - WINDOW HANDLES

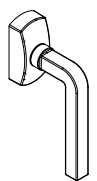
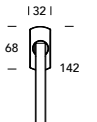
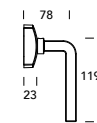
J27DKE69	Bezeichnung - Description	Farbe - Finishes	Alte Art.-Nr. - Old code	1 Stück - Piece
  	Fensterolive Ros. 33x69 ohne Rastergehäuse (separat zu notieren*) <i>Dreh Kipp on rose mm 33x69 without mechanism (to be ordered separately*)</i>	Chrom - Polished chrome	373-410-10E-000	1AJ27DKE690005XJA
		Schwarz RAL 9005 - Matt black RAL 9005	373-410-10E-180	1AJ27DKE690018XJA
	Fensterolive Ros. 33x69 inklusive Rastergehäuse mit 30 mm vorstehendem Stift <i>Dreh Kipp on rose mm 33x69 and 7x30 mm spindle (mechanism included)</i>	Chrom - Polished chrome	373-410-00E-000	1AJ27DKE693005XJA
		Schwarz RAL 9005 - Matt black RAL 9005	373-410-00E-180	1AJ27DKE693018XJA
	Fensterolive Ros. 33x69 inklusive Rastergehäuse mit 35 mm vorstehendem Stift <i>Dreh Kipp on rose mm 33x69 and 7x35 mm spindle (mechanism included)</i>	Chrom - Polished chrome	373-410-20E-000	1AJ27DKE693505XJA
		Schwarz RAL 9005 - Matt black RAL 9005	373-410-20E-180	1AJ27DKE693518XJA

*Rastergehäuse finden Sie auf Seite 172 / For mechanism please see page 172

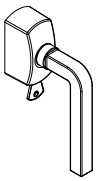
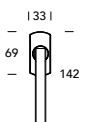
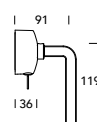
J27DKE70	Bezeichnung - Description	Farbe - Finishes	Alte Art.-Nr. - Old code	1 Stück - Piece
  	Fensterolive Ros. 33x69 abschließbar ohne Rastergehäuse (separat zu notieren*) <i>Dreh Kipp with key on rose mm 33x69 without mechanism (to be ordered separately*)</i>	Chrom - Polished chrome	373-310-10E-000	1AJ27DKE700005XJA
		Schwarz RAL 9005 - Matt black RAL 9005	373-310-10E-180	1AJ27DKE700018XJA
	Fensterolive Ros. 33x69 abschließbar inklusive Rastergehäuse mit 30 mm vorstehendem Stift <i>Dreh Kipp with key on rose mm 33x69 and 7x30 mm spindle (mechanism included)</i>	Chrom - Polished chrome	373-310-00E-000	1AJ27DKE703005XJA
		Schwarz RAL 9005 - Matt black RAL 9005	373-310-00E-180	1AJ27DKE703018XJA
	Fensterolive Ros. 33x69 abschließbar inklusive Rastergehäuse mit 35 mm vorstehendem Stift <i>Dreh Kipp with key on rose mm 33x69 and 7x35 mm spindle (mechanism included)</i>	Chrom - Polished chrome	373-310-20E-000	1AJ27DKE703505XJA
		Schwarz RAL 9005 - Matt black RAL 9005	373-310-20E-180	1AJ27DKE703518XJA

*Rastergehäuse finden Sie auf Seite 172 / For mechanism please see page 172

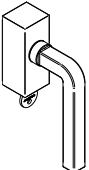
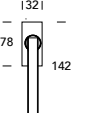
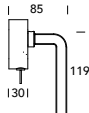
J27DKC81	Bezeichnung - Description	Farbe - Finishes	Alte Art.-Nr. - Old code	1 Stück - Piece
   	Fensterolive "RC 2" zertifiziert Ros. 32x78 ohne Rastergehäuse (separat zu notieren*) <i>DK with key RC2 certified on rose 32x78 without mechanism (to be ordered separately*)</i>	Chrom - Polished chrome Schwarz RAL 9005 - Matt black RAL 9005	373-C81-10E-000 373-C81-10E-180	1AJ27DKC810005XJA 1AJ27DKC810018XJA
	Fensterolive "RC 2" zertifiziert Ros. 32x78 inklusive Rastergehäuse mit 30 mm vorstehendem Stift <i>DK with key RC2 certified on rose 32x78 and 7x30 mm spindle (mechanism included)</i>	Chrom - Polished chrome Schwarz RAL 9005 - Matt black RAL 9005	373-C81-00E-000 373-C81-00E-180	1AJ27DKC813005XJA 1AJ27DKC813018XJA
	Fensterolive "RC 2" zertifiziert Ros. 32x78 inklusive Reastergehäuse mit 35 mm vorstehendem Stift <i>DK with key RC2 certified on rose 32x78 and 7x35 mm spindle (mechanism included)</i>	Chrom - Polished chrome Schwarz RAL 9005 - Matt black RAL 9005	373-C81-20E-000 373-C81-20E-180	1AJ27DKC813505XJA 1AJ27DKC813518XJA
	*Rastergehäuse finden Sie auf Seite 172 / For mechanism please see page 172			

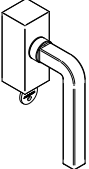
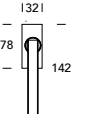
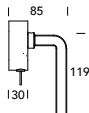
J27DKT81	Bezeichnung - Description	Farbe - Finishes	Alte Art.-Nr. - Old code	1 Stück - Piece
   	Fensterolive mit TBT Funktion Ros. 32x78 ohne Rastergehäuse (separat zu notieren*) <i>Dreh Kipp with key on rose 32x78 with TBT function without mechanism (to be ordered separately*)</i>	Chrom - Polished chrome Schwarz RAL 9005 - Matt black RAL 9005	373-T81-10E-000 373-T81-10E-180	1AJ27DKT810005XJA 1AJ27DKT810018XJA
	Fensterolive mit TBT Funktion Ros. 32x78 inklusive Rastergehäuse mit 30 mm vorstehendem Stift <i>Dreh Kipp with key on rose 32x78 with TBT function and 7x30 mm spindle (mechanism included)</i>	Chrom - Polished chrome Schwarz RAL 9005 - Matt black RAL 9005	373-T81-00E-000 373-T81-00E-180	1AJ27DKT813005XJA 1AJ27DKT813018XJA
	Fensterolive mit TBT Funktion Ros. 32x78 inklusive Reastergehäuse mit 35 mm vorstehendem Stift <i>Dreh Kipp with key on rose 32x78 with TBT function and 7x35 mm spindle (mechanism included)</i>	Chrom - Polished chrome Schwarz RAL 9005 - Matt black RAL 9005	373-T81-20E-000 373-T81-20E-180	1AJ27DKT813505XJA 1AJ27DKT813518XJA
	*Rastergehäuse finden Sie auf Seite 172 / For mechanism please see page 172			

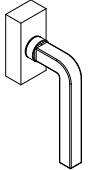
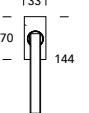
J27DKE82	Bezeichnung - Description	Farbe - Finishes	Alte Art.-Nr. - Old code	1 Stück - Piece
   	Fensterolive rechteckige Ros. 33x70 ohne Rastergehäuse (separat zu notieren*) <i>Dreh Kipp on rose mm 33x70 without mechanism (to be ordered separately*)</i>	Chrom - Polished chrome Schwarz RAL 9005 - Matt black RAL 9005	373-512-10E-000 373-512-10E-180	1AJ27DKE820005XJA 1AJ27DKE820018XJA
	Fensterolive rechteckige Ros. 33x70 inklusive Rastergehäuse mit 30 mm vorstehendem Stift <i>Dreh Kipp on rose mm 33x70 and 7x30 mm spindle (mechanism included)</i>	Chrom - Polished chrome Schwarz RAL 9005 - Matt black RAL 9005	373-512-00E-000 373-512-00E-180	1AJ27DKE823005XJA 1AJ27DKE823018XJA
	Fensterolive rechteckige Ros. 33x70 inklusive Reastergehäuse mit 35 mm vorstehendem Stift <i>Dreh Kipp on rose mm 33x70 and 7x35 mm spindle (mechanism included)</i>	Chrom - Polished chrome Schwarz RAL 9005 - Matt black RAL 9005	373-512-20E-000 373-512-20E-180	1AJ27DKE823505XJA 1AJ27DKE823518XJA
	*Rastergehäuse finden Sie auf Seite 172 / For mechanism please see page 172			

130TKE82	Bezeichnung - Description	Farbe - Finishes	Alte Art.-Nr. - Old code	1 Stück - Piece
	Fensterlive rechteckige Ros. 33x70 ohne Rastergehäuse (separat zu notieren*) <i>TK Dreh Kipp T shape on rose mm 33x70 without mechanism (to be ordered separately*)</i>	Chrom - Polished chrome	373-512-1TE-000	1A130TKE820005XJA
		Schwarz RAL 9005 - Matt black RAL 9005	373-512-1TE-180	1A130TKE820018XJA
	Fensterlive rechteckige Ros. 33x70 inklusive Rastergehäuse mit 30 mm vorstehendem Stift <i>TK Dreh Kipp T shape on rose mm 33x70 and 7x30 mm spindle (mechanism included)</i>	Chrom - Polished chrome	373-512-0TE-000	1A130TKE823005XJA
		Schwarz RAL 9005 - Matt black RAL 9005	373-512-0TE-180	1A130TKE823018XJA
	Fensterlive rechteckige Ros. 33x70 inklusive Rastergehäuse mit 35 mm vorstehendem Stift <i>TK Dreh Kipp T shape on rose mm 33x70 and 7x35 mm spindle (mechanism included)</i>	Chrom - Polished chrome	373-512-2TE-000	1A130TKE823505XJA
		Schwarz RAL 9005 - Matt black RAL 9005	373-512-2TE-180	1A130TKE823518XJA

*Rastergehäuse finden Sie auf Seite 172 / For mechanism please see page 172

J27SEJQ6	Bezeichnung - Description	Farbe - Finishes	Alte Art.-Nr. - Old code	1 Stück - Piece	
	Fensterlive mit rechteckige Rosette ohne Rasterung mit 7x30 mm Vorstehendem Stift <i>Window handle without mechanism on rectangular rose with 7mm spindle</i>	Chrom - Polished chrome	373-0Q6-000-000	1AJ27SEJQ65105XJA	
		Schwarz RAL 9005 - Matt black RAL 9005	373-0Q6-000-180	1AJ27SEJQ65118XJA	

130MAJQ6	Bezeichnung - Description	Farbe - Finishes	Alte Art.-Nr. - Old code	1 Stück - Piece	
	Fensterlive mit rechteckige Rosette ohne Rasterung mit 7x30 mm Vorstehendem Stift <i>Window handle without mechanism on rectangular rose with 7mm spindle</i>	Chrom - Polished chrome	373-TQ6-000-000	1A130MAJQ65105XJA	
		Schwarz RAL 9005 - Matt black RAL 9005	373-TQ6-000-180	1A130MAJQ65118XJA	

Lighthouse J36

MESSING - BRASS

Datenblatt
Datasheet



05
Chrom
Polished chrome



46
Ultra Messing
PVD Gold



8B
Antik Nickel
Antique nickel



98
Ultra Mattnickel
PVD Satin inox

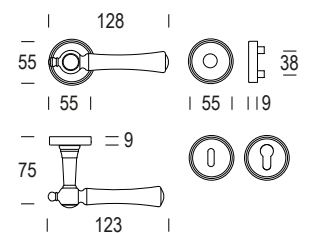

TÜRDRÜCKERGARNITUREN



J36MRJ36

WECHSELGARNITUREN



J36PMJ36

WC GARNITUREN



J36RJJ36

FENSTERGRIFFE



J36DKE66



J36DKE69



J36DKE70



J36DKC80

















J36DKT80

SCHUTZGARNITUREN



953GF420

Seite 194 / page 194

J36MRJ36	Bezeichnung - Description	Farbe - Finishes	Alte Art.-Nr. - Old code	1 Stück - Piece		
	Doppelte Bezeichnung Ø55x9 mm Schlüssellochung Pair lever handle on rose Ø55x9 mm key hole	Chrom - Polished chrome	428-428-A00-000	1AJ36MRJ363105EJA		
		Ultra Messing - PVD Gold 	428-428-A00-367	1AJ36MRJ363146EJA		
		Antik Nickel - Antique Nickel	428-428-A00-444	1AJ36MRJ36318BEJA		
		Ultra Mattnickel - PVD Satin inox 	428-428-A00-066	1AJ36MRJ363198EJA		
	Doppelte Bezeichnung Ø55x9 mm PZ Pair lever handle on rose Ø55x9 mm euro profile cylinder hole	Chrom - Polished chrome	428-428-B00-000	1AJ36MRJ363205EJA		
		Ultra Messing - PVD Gold 	428-428-B00-367	1AJ36MRJ363246EJA		
		Antik Nickel - Antique Nickel	428-428-B00-444	1AJ36MRJ36328BEJA		
		Ultra Mattnickel - PVD Satin inox 	428-428-B00-066	1AJ36MRJ363298EJA		
J36PMJ36	Bezeichnung - Description	Farbe - Finishes	Alte Art.-Nr. - Old code	1 Stück - Piece		
			WE-Garnitur mit Knopf J01 (420) PZ rechtszeigend Entrance set lever handle / knob J01 (420) Euro profile cylinder hole (right hand)	Chrom - Polished chrome	428-428-D00-000	1AJ36PMJ363205JJA
				Ultra Messing - PVD Gold 	428-428-D00-367	1AJ36PMJ363246JJA
				Antik Nickel - Antique Nickel	428-428-D00-444	1AJ36PMJ36328BJJA
Ultra Mattnickel - PVD Satin inox 	428-428-D00-066			1AJ36PMJ363298JJA		
	WE-Garnitur mit Knopf J01 (420) PZ linkszeigend Entrance set lever handle / knob J01 (420) Euro profile cylinder hole (left hand)	Chrom - Polished chrome	428-428-C00-000	1AJ36PMJ363205LJA		
		Ultra Messing - PVD Gold 	428-428-C00-367	1AJ36PMJ363246LJA		
		Antik Nickel - Antique Nickel	428-428-C00-444	1AJ36PMJ36328BLJA		
		Ultra Mattnickel - PVD Satin inox 	428-428-C00-066	1AJ36PMJ363298LJA		
J36RJJ36	Bezeichnung - Description	Farbe - Finishes	Alte Art.-Nr. - Old code	1 Stück - Piece		
			WC-Garnitur mit Rosetten Ø55x9 mm mit Riegel & Schlitzschraube 8mm VK Pair lever handle on rose Ø55x9 mm with turn and release with 8 mm spindle	Chrom - Polished chrome	428-428-E00-000	1AJ36RJJ364205EJA
				Ultra Messing - PVD Gold 	428-428-E00-367	1AJ36RJJ364246EJA
				Antik Nickel - Antique Nickel	428-428-E00-444	1AJ36RJJ36428BEJA
Ultra Mattnickel - PVD Satin inox 	428-428-E00-066			1AJ36RJJ364298EJA		

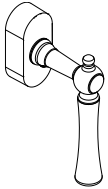
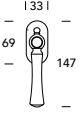
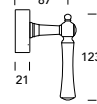
J36DKE66	Bezeichnung - Description	Farbe - Finishes	Alte Art.-Nr. - Old code	1 Stück - Piece
  	Fensterolive Ros. 33x69 ohne Rastergehäuse (separat zu notieren*) <i>Dreh Kipp on rose mm 33x69 without mechanism (to be ordered separately*)</i>	Chrom - Polished chrome	428-510-10E-000	1AJ36DKE660005XJA
		Ultra Messing - PVD Gold	428-510-10E-367	1AJ36DKE660046XJA
		Antik Nickel - Antique Nickel	428-510-10E-444	1AJ36DKE660088XJA
		Ultra Mattnickel - PVD Satin inox	428-510-10E-066	1AJ36DKE660098XJA
	Fensterolive Ros. 33x69 inklusive Rastergehäuse mit 30 mm vorstehendem Stift <i>Dreh Kipp on rose mm 33x69 and 7x30 mm spindle (mechanism included)</i>	Chrom - Polished chrome	428-510-00E-000	1AJ36DKE663005XJA
		Ultra Messing - PVD Gold	428-510-00E-367	1AJ36DKE663046XJA
		Antik Nickel - Antique Nickel	428-510-00E-444	1AJ36DKE663088XJA
		Ultra Mattnickel - PVD Satin inox	428-510-00E-066	1AJ36DKE663098XJA
	Fensterolive Ros. 33x69 inklusive Reastergehäuse mit 35 mm vorstehendem Stift <i>Dreh Kipp on rose mm 33x69 and 7x35 mm spindle (mechanism included)</i>	Chrom - Polished chrome	428-510-20E-000	1AJ36DKE663505XJA
		Ultra Messing - PVD Gold	428-510-20E-367	1AJ36DKE663546XJA
		Antik Nickel - Antique Nickel	428-510-20E-444	1AJ36DKE663588XJA
		Ultra Mattnickel - PVD Satin inox	428-510-20E-066	1AJ36DKE663598XJA

*Rastergehäuse finden Sie auf Seite 172 / For mechanism please see page 172

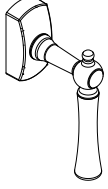
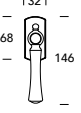
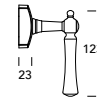
J36DKE69	Bezeichnung - Description	Farbe - Finishes	Alte Art.-Nr. - Old code	1 Stück - Piece
  	Fensterolive Ros. 33x69 ohne Rastergehäuse (separat zu notieren*) <i>Dreh Kipp on rose mm 33x69 without mechanism (to be ordered separately*)</i>	Chrom - Polished chrome	428-410-10E-000	1AJ36DKE690005XJA
		Ultra Messing - PVD Gold	428-410-10E-367	1AJ36DKE690046XJA
		Antik Nickel - Antique Nickel	428-410-10E-444	1AJ36DKE690088XJA
		Ultra Mattnickel - PVD Satin inox	428-410-10E-066	1AJ36DKE690098XJA
	Fensterolive Ros. 33x69 inklusive Rastergehäuse mit 30 mm vorstehendem Stift <i>Dreh Kipp on rose mm 33x69 and 7x30 mm spindle (mechanism included)</i>	Chrom - Polished chrome	428-410-00E-000	1AJ36DKE693005XJA
		Ultra Messing - PVD Gold	428-410-00E-367	1AJ36DKE693046XJA
		Antik Nickel - Antique Nickel	428-410-00E-444	1AJ36DKE693088XJA
		Ultra Mattnickel - PVD Satin inox	428-410-00E-066	1AJ36DKE693098XJA
	Fensterolive Ros. 33x69 inklusive Reastergehäuse mit 35 mm vorstehendem Stift <i>Dreh Kipp on rose mm 33x69 and 7x35 mm spindle (mechanism included)</i>	Chrom - Polished chrome	428-410-20E-000	1AJ36DKE693505XJA
		Ultra Messing - PVD Gold	428-410-20E-367	1AJ36DKE693546XJA
		Antik Nickel - Antique Nickel	428-410-20E-444	1AJ36DKE693588XJA
		Ultra Mattnickel - PVD Satin inox	428-410-20E-066	1AJ36DKE693598XJA



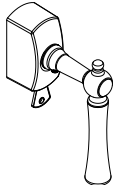
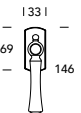
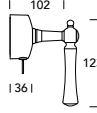

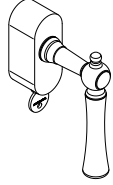
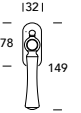
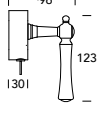

*Rastergehäuse finden Sie auf Seite 172 / For mechanism please see page 172

J36DKE70	Bezeichnung - Description	Farbe - Finishes	Alte Art.-Nr. - Old code	1 Stück - Piece
   	Fensterolive Ros. 33x69 abschließbar ohne Rastergehäuse (separat zu notieren*) Dreh Kipp with key on rose mm 33x69 without mechanism (to be ordered separately*)	Chrom - Polished chrome	428-310-10E-000	1AJ36DKE700005XJA
		Ultra Messing - PVD Gold	428-310-10E-367	1AJ36DKE700046XJA
		Antik Nickel - Antique Nickel	428-310-10E-444	1AJ36DKE70008BXJA
		Ultra Mattnickel - PVD Satin inox	428-310-10E-066	1AJ36DKE700098XJA
	Fensterolive Ros. 33x69 abschließbar inklusive Rastergehäuse mit 30 mm vorstehendem Stift Dreh Kipp with key on rose mm 33x69 and 7x30 mm spindle (mechanism included)	Chrom - Polished chrome	428-310-00E-000	1AJ36DKE703005XJA
		Ultra Messing - PVD Gold	428-310-00E-367	1AJ36DKE703046XJA
		Antik Nickel - Antique Nickel	428-310-00E-444	1AJ36DKE70308BXJA
		Ultra Mattnickel - PVD Satin inox	428-310-00E-066	1AJ36DKE703098XJA
	Fensterolive Ros. 33x69 abschließbar inklusive Rastergehäuse mit 35 mm vorstehendem Stift Dreh Kipp with key on rose mm 33x69 and 7x35 mm spindle (mechanism included)	Chrom - Polished chrome	428-310-20E-000	1AJ36DKE703505XJA
		Ultra Messing - PVD Gold	428-310-20E-367	1AJ36DKE703546XJA
		Antik Nickel - Antique Nickel	428-310-20E-444	1AJ36DKE70358BXJA
		Ultra Mattnickel - PVD Satin inox	428-310-20E-066	1AJ36DKE703598XJA

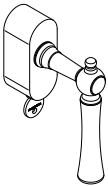
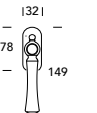
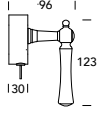
*Rastergehäuse finden Sie auf Seite 172 / For mechanism please see page 172

J36DKC80	Bezeichnung - Description	Farbe - Finishes	Alte Art.-Nr. - Old code	1 Stück - Piece
   	Fensterolive "RC 2" zertifiziert Ros. 32x78 ohne Rastergehäuse (separat zu notieren*) DK with key RC2 certified on rose 32x78 without mechanism (to be ordered separately*)	Chrom - Polished chrome	428-C80-10E-000	1AJ36DKC800005XJA
		Ultra Messing - PVD Gold	428-C80-10E-367	1AJ36DKC800046XJA
		Antik Nickel - Antique Nickel	428-C80-10E-444	1AJ36DKC80008BXJA
		Ultra Mattnickel - PVD Satin inox	428-C80-10E-066	1AJ36DKC800098XJA
	Fensterolive "RC 2" zertifiziert Ros. 32x78 inklusive Rastergehäuse mit 30 mm vorstehendem Stift DK with key RC2 certified on rose 32x78 and 7x30 mm spindle (mechanism included)	Chrom - Polished chrome	428-C80-00E-000	1AJ36DKC803005XJA
		Ultra Messing - PVD Gold	428-C80-00E-367	1AJ36DKC803046XJA
		Antik Nickel - Antique Nickel	428-C80-00E-444	1AJ36DKC80308BXJA
		Ultra Mattnickel - PVD Satin inox	428-C80-00E-066	1AJ36DKC803098XJA
	Fensterolive "RC 2" zertifiziert Ros. 32x78 inklusive Rastergehäuse mit 35 mm vorstehendem Stift DK with key RC2 certified on rose 32x78 and 7x35 mm spindle (mechanism included)	Chrom - Polished chrome	428-C80-20E-000	1AJ36DKC803505XJA
		Ultra Messing - PVD Gold	428-C80-20E-367	1AJ36DKC803546XJA
		Antik Nickel - Antique Nickel	428-C80-20E-444	1AJ36DKC80358BXJA
		Ultra Mattnickel - PVD Satin inox	428-C80-20E-066	1AJ36DKC803598XJA

*Rastergehäuse finden Sie auf Seite 172 / For mechanism please see page 172

J36DKT80	Bezeichnung - Description	Farbe - Finishes	Alte Art.-Nr. - Old code	1 Stück - Piece
  	<p>Fensterlive mit TBT Funktion Ros. 32x78 ohne Rastergehäuse (separat zu notieren*)</p> <p>Dreh Kipp with key on rose 32x78 with TBT function without mechanism (to be ordered separately*)</p>	<p>Chrom - Polished chrome</p> <p>Ultra Messing - PVD Gold </p> <p>Antik Nickel - Antique Nickel</p> <p>Ultra Mattnickel - PVD Satin inox </p>	<p>428-T80-10E-000</p> <p>428-T80-10E-367</p> <p>428-T80-10E-444</p> <p>428-T80-10E-066</p>	<p>1AJ36DKT800005XJA</p> <p>1AJ36DKT800046XJA</p> <p>1AJ36DKT80008BXJA</p> <p>1AJ36DKT800098XJA</p>
	<p>Fensterlive mit TBT Funktion Ros. 32x78 inklusive Rastergehäuse mit 30 mm vorstehendem Stift</p> <p>Dreh Kipp with key on rose 32x78 with TBT function and 7x30 mm spindle (mechanism included)</p>	<p>Chrom - Polished chrome</p> <p>Ultra Messing - PVD Gold </p> <p>Antik Nickel - Antique Nickel</p> <p>Ultra Mattnickel - PVD Satin inox </p>	<p>428-T80-00E-000</p> <p>428-T80-00E-367</p> <p>428-T80-00E-444</p> <p>428-T80-00E-066</p>	<p>1AJ36DKT803005XJA</p> <p>1AJ36DKT803046XJA</p> <p>1AJ36DKT80308BXJA</p> <p>1AJ36DKT803098XJA</p>
	<p>Fensterlive mit TBT Funktion Ros. 32x78 inklusive Reastergehäuse mit 35 mm vorstehendem Stift</p> <p>Dreh Kipp with key on rose 32x78 with TBT function and 7x35 mm spindle (mechanism included)</p>	<p>Chrom - Polished chrome</p> <p>Ultra Messing - PVD Gold </p> <p>Antik Nickel - Antique Nickel</p> <p>Ultra Mattnickel - PVD Satin inox </p>	<p>428-T80-20E-000</p> <p>428-T80-20E-367</p> <p>428-T80-20E-444</p> <p>428-T80-20E-066</p>	<p>1AJ36DKT803505XJA</p> <p>1AJ36DKT803546XJA</p> <p>1AJ36DKT80358BXJA</p> <p>1AJ36DKT803598XJA</p>

*Rastergehäuse finden Sie auf Seite 172 / For mechanism please see page 172

Metropol Holz J35

MESSING - BRASS

Datenblatt
Datasheet



6P

Ultra Mattnickel / Schwarz
PVD Satin inox / Dark wood



L6

Chrom / Schwarz
Chrome / Dark wood



82 JATEC

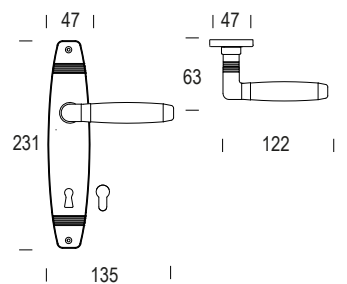

TÜRDRÜCKERGARNITUREN



J35MRJ03



J35MPJ35

WECHSELGARNITUREN



J35PMJ03



J35PMJ35

WC GARNITUREN



J35JRJ03



J35JPJ35











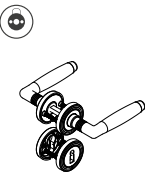

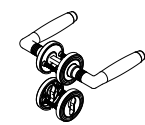

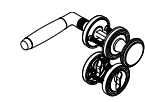
FENSTERGRIFFE



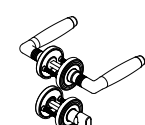

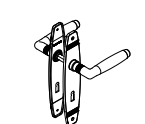

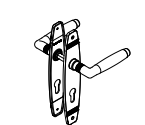

J35DKE69 *









J35DKE70 *







J35MRJ03	Bezeichnung - Description	Farbe - Finishes	Alte Art.-Nr. - Old code	1 Stück - Piece
	Doppelte Bezeichnung Ø55x9 mm Schlüssellochung <i>Pair lever handle on rose Ø55x9 mm key hole</i>	Ultra Mattnic./Holz Schwarz - Dark wood/PVD Sat. inox 	417-993-A00-280	1AJ35MRJ03316PEJA
		Chrom/Holz Schwarz - Dark Wood/Polished chrome	417-993-A00-002	1AJ35MRJ0331L6EJA
	Doppelte Bezeichnung Ø55x9 mm PZ <i>Pair lever handle on rose Ø55x9 mm euro profile cylinder hole</i>	Ultra Mattnic./Holz Schwarz - Dark wood/PVD Sat. inox 	417-993-B00-280	1AJ35MRJ03326PEJA
		Chrom/Holz Schwarz - Dark Wood/Polished chrome	417-993-B00-002	1AJ35MRJ0332L6EJA
	WE-Garnitur mit Knopf J02 (922) PZ rechtszeigend <i>Entrance set lever handle / knob J02 (922) Euro profile cylinder hole (right hand)</i>	Ultra Mattnic./Holz Schwarz - Dark wood/PVD Sat. inox 	417-993-D00-280	1AJ35PMJ03326PJJA
		Chrom/Holz Schwarz - Dark Wood/Polished chrome	417-993-D00-002	1AJ35PMJ0332L6JJJA
	WE-Garnitur mit Knopf J02 (922) PZ linkszeigend <i>Entrance set lever handle / knob J02 (922) Euro profile cylinder hole (left hand)</i>	Ultra Mattnic./Holz Schwarz - Dark wood/PVD Sat. inox 	417-993-C00-280	1AJ35PMJ03326PLJA
		Chrom/Holz Schwarz - Dark Wood/Polished chrome	417-993-C00-002	1AJ35PMJ0332L6LJA
	WC-Garnitur mit Rosetten Ø55x9 mm mit Riegel & Schlitzschraube <i>Pair lever handle on rose Ø55x9 mm with turn and release</i>	Ultra Mattnic./Holz Schwarz - Dark wood/PVD Sat. inox 	417-993-E00-280	1AJ35JRJ03426PEJA
		Chrom/Holz Schwarz - Dark Wood/Polished chrome	417-993-E00-002	1AJ35JRJ0342L6EJA
	ZT-Garnitur mit Schild 46x230 mm mit BB 72 mm <i>Pair lever handle on plate mm 46x230 with BB key hole 72mm</i>	Ultra Mattnic./Holz Schwarz - Dark wood/PVD Sat. inox 	417-356-100-280	1AJ35MPJ35B66PXJA
		Chrom/Holz Schwarz - Dark Wood/Polished chrome	417-356-100-002	1AJ35MPJ35B6L6XJA
	ZT-Garnitur mit Schild 46x230 mm mit PZ 72 mm <i>Pair lever handle on plate mm 46x230 with Euro Profile cylinder hole 72mm</i>	Ultra Mattnic./Holz Schwarz - Dark wood/PVD Sat. inox 	417-356-200-280	1AJ35MPJ35136PXJA
		Chrom/Holz Schwarz - Dark Wood/Polished chrome	417-356-200-002	1AJ35MPJ3513L6XJA

J35PMJ35	Bezeichnung - Description	Farbe - Finishes	Alte Art.-Nr. - Old code	1 Stück - Piece
	WE-Garnitur mit Knopf J01 (420) 72 mm PZ rechtszeigend <i>Entrance set lever handle / knob J01 (420) with Euro Profile cylinder hole 72mm (right hand)</i>	Ultra Mattnic./Holz Schwarz - Dark wood/PVD Sat. inox 	417-356-400-280	1AJ35PMJ35136PJJA
		Chrom/Holz Schwarz - Dark Wood/Polished chrome	417-356-400-002	1AJ35PMJ3513L6JJJA
	WE-Garnitur mit Knopf J01 (420) 72 mm PZ linkszeigend <i>Entrance set lever handle / knob J01 (420) with Euro Profile cylinder hole 72mm (left hand)</i>	Ultra Mattnic./Holz Schwarz - Dark wood/PVD Sat. inox 	417-356-300-280	1AJ35PMJ35136PLJA
		Chrom/Holz Schwarz - Dark Wood/Polished chrome	417-356-300-002	1AJ35PMJ3513L6LJA
	J35JPJ35 WC-Garnitur mit Schild 46x230 mm mit Riegel & Schlitzschraube <i>Pair lever handle on plate mm 46x230 with WC turn and release</i>	Ultra Mattnic./Holz Schwarz - Dark wood/PVD Sat. inox 	417-356-600-280	1AJ35JPJ35246PVJA
		Chrom/Holz Schwarz - Dark Wood/Polished chrome	417-356-600-002	1AJ35JPJ3524L6VJA

FENSTERGRIFFE - WINDOW HANDLES

J35DKE69	Bezeichnung - Description	Farbe - Finishes	Alte Art.-Nr. - Old code	1 Stück - Piece
   	Fensterolive Ros. 33x69 ohne Rastergehäuse (separat zu notieren*) <i>Dreh Kipp on rose mm 33x69 without mechanism (to be ordered separately*)</i>	Ultra Mattnic./Holz Schwarz - Dark wood/PVD Sat. inox 	417-410-10E-280	1AJ35DKE69006PXJA
		Chrom/Holz Schwarz - Dark Wood/Polished chrome	417-410-10E-002	1AJ35DKE6900L6XJA
	Fensterolive Ros. 33x69 inklusive Rastergehäuse mit 30 mm vorstehendem Stift <i>Dreh Kipp on rose mm 33x69 and 7x30 mm spindle (mechanism included)</i>	Ultra Mattnic./Holz Schwarz - Dark wood/PVD Sat. inox 	417-410-00E-280	1AJ35DKE69306PXJA
		Chrom/Holz Schwarz - Dark Wood/Polished chrome	417-410-00E-002	1AJ35DKE6930L6XJA
	Fensterolive Ros. 33x69 inklusive Reastergehäuse mit 35 mm vorstehendem Stift <i>Dreh Kipp on rose mm 33x69 and 7x35 mm spindle (mechanism included)</i>	Ultra Mattnic./Holz Schwarz - Dark wood/PVD Sat. inox 	417-410-20E-280	1AJ35DKE69356PXJA
		Chrom/Holz Schwarz - Dark Wood/Polished chrome	417-410-20E-002	1AJ35DKE6935L6XJA

*Rastergehäuse finden Sie auf Seite 172 / For mechanism please see page 172

J35DKE70	Bezeichnung - Description	Farbe - Finishes	Alte Art.-Nr. - Old code	1 Stück - Piece
   	Fensterolive Ros. 33x69 abschließbar ohne Rastergehäuse (separat zu notieren*) <i>Dreh Kipp with key on rose mm 33x69 without mechanism (to be ordered separately*)</i>	Ultra Mattnic./Holz Schwarz - Dark wood/PVD Sat. inox 	417-310-10E-280	1AJ35DKE70006PXJA
		Chrom/Holz Schwarz - Dark Wood/Polished chrome	417-310-10E-002	1AJ35DKE7000L6XJA
	Fensterolive Ros. 33x69 abschließbar inklusive Rastergehäuse mit 30 mm vorstehendem Stift <i>Dreh Kipp with key on rose mm 33x69 and 7x30 mm spindle (mechanism included)</i>	Ultra Mattnic./Holz Schwarz - Dark wood/PVD Sat. inox 	417-310-00E-280	1AJ35DKE70306PXJA
		Chrom/Holz Schwarz - Dark Wood/Polished chrome	417-310-00E-002	1AJ35DKE7030L6XJA
	Fensterolive Ros. 33x69 abschließbar inklusive Rastergehäuse mit 35 mm vorstehendem Stift <i>Dreh Kipp with key on rose mm 33x69 and 7x35 mm spindle (mechanism included)</i>	Ultra Mattnic./Holz Schwarz - Dark wood/PVD Sat. inox 	417-310-20E-280	1AJ35DKE70356PXJA
		Chrom/Holz Schwarz - Dark Wood/Polished chrome	417-310-20E-002	1AJ35DKE7035L6XJA

*Rastergehäuse finden Sie auf Seite 172 / For mechanism please see page 172



Montparnasse J01

MESSING - BRASS

Datenblatt
Datasheet



05
Chrom
Polished chrome



46
Ultra Messing
PVD Gold



98
Ultra Mattnickel
PVD Satin inox



5S
Edelstahl
Stainless steel 304

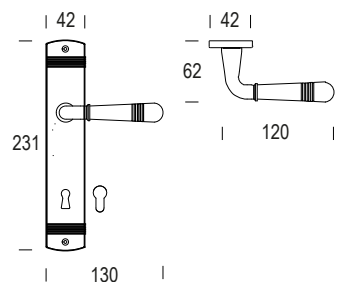
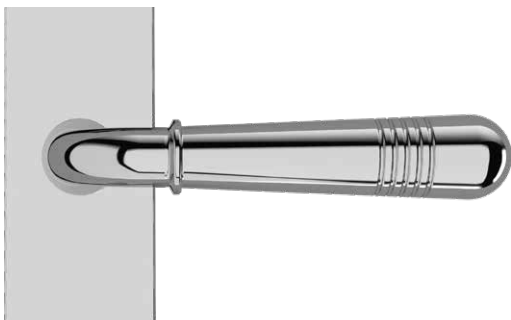

TÜRDRÜCKERGARNITUREN



J01MRJ03



J01MPJ01 *

WECHSELGARNITUREN



J01PMJ03



J01PMJ01 *

WC GARNITUREN



J01RJJ03



J01PJJ01 *

FENSTERGRIFFE



J01DKE66



J01DKC80



J01DKT80



SCHUTZGARNITUREN



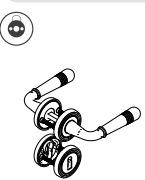
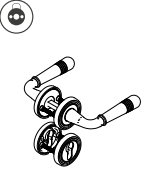
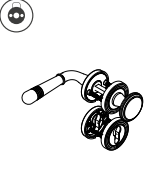

354AC421

Seite 226 / page 226

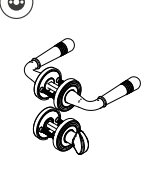
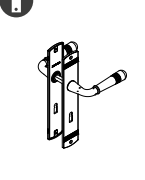
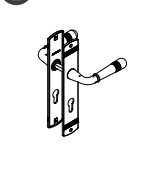

J01MRJ03	Bezeichnung - Description	Farbe - Finishes	Alte Art.-Nr. - Old code	1 Stück - Piece
	Doppelte Bezeichnung Ø55x9 mm Schlüssellochung <i>Pair lever handle on rose Ø55x9 mm key hole</i>	Chrom - Polished chrome	416-993-A00-000	1AJ01MRJ033105EJA
		Ultra Messing - PVD Gold	416-993-A00-367	1AJ01MRJ033146EJA
		Edelstahl - Stainless steel 304	416-993-A00-055	1AJ01MRJ033155EJA
		Ultra Mattnickel - PVD Satin inox	416-993-A00-066	1AJ01MRJ033198EJA
	Doppelte Bezeichnung Ø55x9 mm PZ <i>Pair lever handle on rose Ø55x9 mm euro profile cylinder hole</i>	Chrom - Polished chrome	416-993-B00-000	1AJ01MRJ033205EJA
		Ultra Messing - PVD Gold	416-993-B00-367	1AJ01MRJ033246EJA
		Edelstahl - Stainless steel 304	416-993-B00-055	1AJ01MRJ033255EJA
		Ultra Mattnickel - PVD Satin inox	416-993-B00-066	1AJ01MRJ033298EJA
	WE-Garnitur mit Knopf J02 (922) PZ rechtszeigend <i>Entrance set lever handle / knob J02 (922) Euro profile cylinder hole (right hand)</i>	Chrom - Polished chrome	416-993-D00-000	1AJ01PMJ033205JJA
		Ultra Messing - PVD Gold	416-993-D00-367	1AJ01PMJ033246JJA
		Edelstahl - Stainless steel 304	416-993-D00-055	1AJ01PMJ033255JJA
		Ultra Mattnickel - PVD Satin inox	416-993-D00-066	1AJ01PMJ033298JJA
	WE-Garnitur mit Knopf J02 (922) PZ linkszeigend <i>Entrance set lever handle / knob J02 (922) Euro profile cylinder hole (left hand)</i>	Chrom - Polished chrome	416-993-C00-000	1AJ01PMJ033205LJA
		Ultra Messing - PVD Gold	416-993-C00-367	1AJ01PMJ033246LJA
		Edelstahl - Stainless steel 304	416-993-C00-055	1AJ01PMJ033255LJA
		Ultra Mattnickel - PVD Satin inox	416-993-C00-066	1AJ01PMJ033298LJA
	WC-Garnitur mit Rosetten Ø55x9 mm mit Riegel & Schlitzschraube 8mm VK <i>Pair lever handle on rose Ø55x9 mm with turn and release with 8 mm spindle</i>	Chrom - Polished chrome	416-993-E00-000	1AJ01RJJ034205EJA
		Ultra Messing - PVD Gold	416-993-E00-367	1AJ01RJJ034246EJA
		Edelstahl - Stainless steel 304	416-993-E00-055	1AJ01RJJ034255EJA
		Ultra Mattnickel - PVD Satin inox	416-993-E00-066	1AJ01RJJ034298EJA
	ZT-Garnitur mit Schild 43x231 mm mit BB 72 mm <i>Pair lever handle on plate mm 43x231 with BB key hole 72mm</i>	Chrom - Polished chrome	416-354-100-000	1AJ01MPJ01B605XJA
		Ultra Messing - PVD Gold	416-354-100-367	1AJ01MPJ01B646XJA
		Ultra Mattnickel - PVD Satin inox	416-354-100-066	1AJ01MPJ01B698XJA
			ZT-Garnitur mit Schild 43x231 mm mit PZ 72 mm <i>Pair lever handle on plate mm 43x231 with Euro Profile cylinder hole 72mm</i>	Chrom - Polished chrome
Ultra Messing - PVD Gold	416-354-200-367			1AJ01MPJ011346XJA
Ultra Mattnickel - PVD Satin inox	416-354-200-066			1AJ01MPJ011398XJA

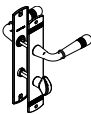

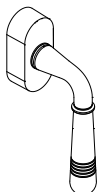
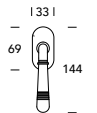
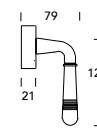

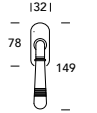
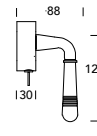

J01PMJ01	Bezeichnung - Description	Farbe - Finishes	Alte Art.-Nr. - Old code	1 Stück - Piece
	WE-Garnitur mit Knopf J01 (420) 72 mm PZ rechtszeigend <i>Entrance set lever handle / knob J01 (420) with Euro Profile cylinder hole 72mm (right hand)</i>	Chrom - Polished chrome	416-354-400-000	1AJ01PMJ011305JJA
		Ultra Messing - PVD Gold	416-354-400-367	1AJ01PMJ011346JJA
		Ultra Mattnickel - PVD Satin inox	416-354-400-066	1AJ01PMJ011398JJA
	WE-Garnitur mit Knopf J01 (420) 72 mm PZ linkszeigend <i>Entrance set lever handle / knob J01 (420) with Euro Profile cylinder hole 72mm (left hand)</i>	Chrom - Polished chrome	416-354-300-000	1AJ01PMJ011305LJA
		Ultra Messing - PVD Gold	416-354-300-367	1AJ01PMJ011346LJA
		Ultra Mattnickel - PVD Satin inox	416-354-300-066	1AJ01PMJ011398LJA
	WC-Garnitur mit Schild 43x231 mm mit Riegel & Schlitzschraube 8mm VK <i>Pair lever handle on plate mm 43x231 with WC turn and release (8mm WC spindle)</i>	Chrom - Polished chrome	416-354-600-000	1AJ01PJJ012405VJA
		Ultra Messing - PVD Gold	416-354-600-367	1AJ01PJJ012446VJA
		Ultra Mattnickel - PVD Satin inox	416-354-600-066	1AJ01PJJ012498VJA

J01DKE66	Bezeichnung - Description	Farbe - Finishes	Alte Art.-Nr. - Old code	1 Stück - Piece
  	Fensterolive Ros. 33x69 ohne Rastergehäuse (separat zu notieren*) Dreh Kipp on rose mm 33x69 without mechanism (to be ordered separately*)	Chrom - Polished chrome	416-510-110-000	1AJ01DKE660005XJA
		Ultra Messing - PVD Gold	416-510-110-367	1AJ01DKE660046XJA
		Edelstahl - Stainless steel 304	416-510-110-057	1AJ01DKE660055XJA
		Ultra Mattnickel - PVD Satin inox	416-510-110-066	1AJ01DKE660098XJA
	Fensterolive Ros. 33x69 inklusive Rastergehäuse mit 30 mm vorstehendem Stift Dreh Kipp on rose mm 33x69 and 7x30 mm spindle (mechanism included)	Chrom - Polished chrome	416-510-000-000	1AJ01DKE663005XJA
		Ultra Messing - PVD Gold	416-510-000-367	1AJ01DKE663046XJA
		Edelstahl - Stainless steel 304	416-510-000-057	1AJ01DKE663055XJA
		Ultra Mattnickel - PVD Satin inox	416-510-000-066	1AJ01DKE663098XJA
	Fensterolive Ros. 33x69 inklusive Reastergehäuse mit 35 mm vorstehendem Stift Dreh Kipp on rose mm 33x69 and 7x35 mm spindle (mechanism included)	Chrom - Polished chrome	416-510-200-000	1AJ01DKE663505XJA
		Ultra Messing - PVD Gold	416-510-200-367	1AJ01DKE663546XJA
		Edelstahl - Stainless steel 304	416-510-200-057	1AJ01DKE663555XJA
		Ultra Mattnickel - PVD Satin inox	416-510-200-066	1AJ01DKE663598XJA

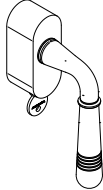
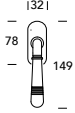
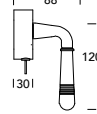
*Rastergehäuse finden Sie auf Seite 172 / For mechanism please see page 172

J01DKC80	Bezeichnung - Description	Farbe - Finishes	Alte Art.-Nr. - Old code	1 Stück - Piece	€/St	
  	Fensterolive "RC 2" zertifiziert Ros. 32x78 ohne Rastergehäuse (separat zu notieren*) DK with key RC2 certified on rose 32x78 without mechanism (to be ordered separately*)	Chrom - Polished chrome	416-C80-10E-000	1AJ01DKC800005XJA		
		Ultra Messing - PVD Gold	416-C80-10E-367	1AJ01DKC800046XJA		
		Edelstahl - Stainless steel 304	416-C80-10E-055	1AJ01DKC800055XJA		
		Ultra Mattnickel - PVD Satin inox	416-C80-10E-066	1AJ01DKC800098XJA		
	Fensterolive "RC 2" zertifiziert Ros. 32x78 inklusive Rastergehäuse mit 30 mm vorstehendem Stift DK with key RC2 certified on rose 32x78 and 7x30 mm spindle (mechanism included)	Chrom - Polished chrome	416-C80-00E-000	1AJ01DKC803005XJA		
		Ultra Messing - PVD Gold	416-C80-00E-367	1AJ01DKC803046XJA		
		Edelstahl - Stainless steel 304	416-C80-00E-055	1AJ01DKC803055XJA		
		Ultra Mattnickel - PVD Satin inox	416-C80-00E-066	1AJ01DKC803098XJA		
	Fensterolive "RC 2" zertifiziert Ros. 32x78 inklusive Reastergehäuse mit 35 mm vorstehendem Stift DK with key RC2 certified on rose 32x78 and 7x35 mm spindle (mechanism included)	Chrom - Polished chrome	416-C80-20E-000	1AJ01DKC803505XJA		
		Ultra Messing - PVD Gold	416-C80-20E-367	1AJ01DKC803546XJA		
		Edelstahl - Stainless steel 304	416-C80-20E-055	1AJ01DKC803555XJA		
		Ultra Mattnickel - PVD Satin inox	416-C80-20E-066	1AJ01DKC803598XJA		

*Rastergehäuse finden Sie auf Seite 172 / For mechanism please see page 172

J01DKT80	Bezeichnung - Description	Farbe - Finishes	Alte Art.-Nr. - Old code	1 Stück - Piece
  	Fensterolive mit TBT Funktion Ros. 32x78 ohne Rastergehäuse (separat zu notieren*) Dreh Kipp with key on rose 32x78 with TBT function without mechanism (to be ordered separately*)	Chrom - Polished chrome Ultra Messing - PVD Gold  Edelstahl - Stainless steel 304 Ultra Mattnickel - PVD Satin inox 	416-T80-10E-000 416-T80-10E-367 416-T80-10E-055 416-T80-10E-066	1AJ01DKT800005XJA 1AJ01DKT800046XJA 1AJ01DKT800055XJA 1AJ01DKT800098XJA
	Fensterolive mit TBT Funktion Ros. 32x78 inklusive Rastergehäuse mit 30 mm vorstehendem Stift Dreh Kipp with key on rose 32x78 with TBT function and 7x30 mm spindle (mechanism included)	Chrom - Polished chrome Ultra Messing - PVD Gold  Edelstahl - Stainless steel 304 Ultra Mattnickel - PVD Satin inox 	416-T80-00E-000 416-T80-00E-367 416-T80-00E-055 416-T80-00E-066	1AJ01DKT803005XJA 1AJ01DKT803046XJA 1AJ01DKT803055XJA 1AJ01DKT803098XJA
	Fensterolive mit TBT Funktion Ros. 32x78 inklusive Reastergehäuse mit 35 mm vorstehendem Stift Dreh Kipp with key on rose 32x78 with TBT function and 7x35 mm spindle (mechanism included)	Chrom - Polished chrome Ultra Messing - PVD Gold  Edelstahl - Stainless steel 304 Ultra Mattnickel - PVD Satin inox 	416-T80-20E-000 416-T80-20E-367 416-T80-20E-055 416-T80-20E-066	1AJ01DKT803505XJA 1AJ01DKT803546XJA 1AJ01DKT803555XJA 1AJ01DKT803598XJA

*Rastergehäuse finden Sie auf Seite 172 / For mechanism please see page 172

Portal 711

MESSING - BRASS

Datenblatt
Datasheet



05
Chrom
Polished chrome



46
Ultra Messing
PVD Gold

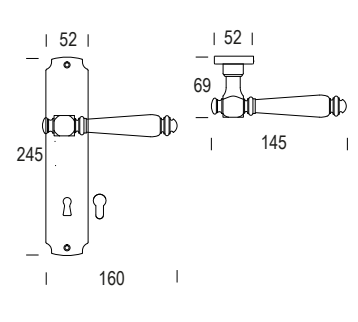
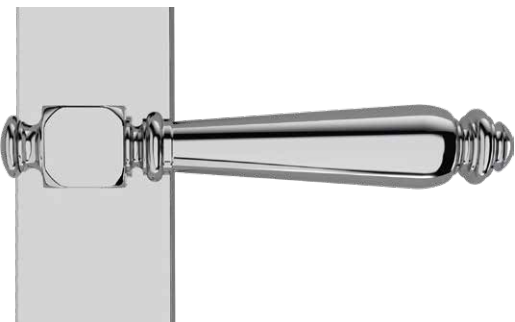

TÜRDRÜCKERGARNITUREN



711MRJ36



711MP710

WECHSELGARNITUREN



711PMJ36



711PM061

WC GARNITUREN



711RJJ36



711PJ710

FENSTERGRIFFE



711DKE69 *



711DKE70 *















SCHUTZGARNITUREN









950AC420

Seite 230 / page 230



711MRJ36	Bezeichnung - Description	Farbe - Finishes	Alte Art.-Nr. - Old code	1 Stück - Piece
	Doppelte Bezeichnung Ø55x9 mm Schlüsselbohrung <i>Pair lever handle on rose Ø55x9 mm key hole</i>	Chrom - Polished chrome	711-428-A00-000	1A711MRJ363105EJA
		Ultra Messing - PVD Gold 	711-428-A00-367	1A711MRJ363146EJA
	Doppelte Bezeichnung Ø55x9 mm PZ <i>Pair lever handle on rose Ø55x9 mm euro profile cylinder hole</i>	Chrom - Polished chrome	711-428-B00-000	1A711MRJ363205EJA
		Ultra Messing - PVD Gold 	711-428-B00-367	1A711MRJ363246EJA
	WE-Garnitur mit Knopf J01 (420) PZ rechtszeigend <i>Entrance set lever handle / knob J01 (420) Euro profile cylinder hole (right hand)</i>	Chrom - Polished chrome	711-428-D00-000	1A711PMJ363205JJA
		Ultra Messing - PVD Gold 	711-428-D00-367	1A711PMJ363246JJA
	WE-Garnitur mit Knopf J01 (420) PZ linkszeigend <i>Entrance set lever handle / knob J01 (420) Euro profile cylinder hole (left hand)</i>	Chrom - Polished chrome	711-428-C00-000	1A711PMJ363205LJA
		Ultra Messing - PVD Gold 	711-428-C00-367	1A711PMJ363246LJA
	WC-Garnitur mit Rosetten Ø55x9 mm mit Riegel & Schlitzschraube 8mm VK <i>Pair lever handle on rose Ø55x9 mm with turn and release with 8 mm spindle</i>	Chrom - Polished chrome	711-428-E00-000	1A711RJJ364205EJA
		Ultra Messing - PVD Gold 	711-428-E00-367	1A711RJJ364246EJA
	ZT-Garnitur mit Schild 52x245 mm mit BB 72 mm <i>Pair lever handle on plate mm 52x245 with BB key hole 72mm</i>	Chrom - Polished chrome	711-710-100-000	1A711MP710B605XJA
		Ultra Messing - PVD Gold 	711-710-100-367	1A711MP710B646XJA
	ZT-Garnitur mit Schild 52x245 mm mit PZ 72 mm <i>Pair lever handle on plate mm 52x245 with Euro Profile cylinder hole 72mm</i>	Chrom - Polished chrome	711-710-200-000	1A711MP7101305XJA
		Ultra Messing - PVD Gold 	711-710-200-367	1A711MP7101346XJA

711PM061	Bezeichnung - Description	Farbe - Finishes	Alte Art.-Nr. - Old code	1 Stück - Piece
	WE-Garnitur mit Knopf J01 (420) 72 mm PZ rechtszeigend <i>Entrance set lever handle / knob J01 (420) with Euro Profile cylinder hole 72mm (right hand)</i>	Chrom - Polished chrome	711-710-400-000	1A711PM0611305JJA
		Ultra Messing - PVD Gold 	711-710-400-367	1A711PM0611346JJA
	WE-Garnitur mit Knopf J01 (420) 72 mm PZ linkszeigend <i>Entrance set lever handle / knob J01 (420) with Euro Profile cylinder hole 72mm (left hand)</i>	Chrom - Polished chrome	711-710-300-000	1A711PM0611305LJA
		Ultra Messing - PVD Gold 	711-710-300-367	1A711PM0611346LJA
	WC-Garnitur mit Schild 52x245 mm mit Riegel & Schlitzschraube 8mm VK <i>Pair lever handle on plate mm 52x245 with WC turn and release (8mm WC spindle)</i>	Chrom - Polished chrome	711-710-600-000	1A711PJ7102405VJA
		Ultra Messing - PVD Gold 	711-710-600-367	1A711PJ7102446VJA

FENSTERGRIFFE - WINDOW HANDLES

711DKE69	Bezeichnung - Description	Farbe - Finishes	Alte Art.-Nr. - Old code	1 Stück - Piece
       	Fensterlive Ros. 33x69 ohne Rastergehäuse (separat zu notieren*) <i>Dreh Kipp on rose mm 33x69 without mechanism (to be ordered separately*)</i>	Chrom - Polished chrome	711-410-10E-000	1A711DKE690005XJA
		Ultra Messing - PVD Gold 	711-410-10E-367	1A711DKE690046XJA
		Fensterlive Ros. 33x69 inklusive Rastergehäuse mit 30 mm vorstehendem Stift <i>Dreh Kipp on rose mm 33x69 and 7x30 mm spindle (mechanism included)</i>	Chrom - Polished chrome	711-410-00E-000
		Ultra Messing - PVD Gold 	711-410-00E-367	1A711DKE693046XJA
	Fensterlive Ros. 33x69 inklusive Reastergehäuse mit 35 mm vorstehendem Stift <i>Dreh Kipp on rose mm 33x69 and 7x35 mm spindle (mechanism included)</i>	Chrom - Polished chrome	711-410-20E-000	1A711DKE693505XJA
		Ultra Messing - PVD Gold 	711-410-20E-367	1A711DKE693546XJA

*Rastergehäuse finden Sie auf Seite 172 / For mechanism please see page 172

711DKE70	Bezeichnung - Description	Farbe - Finishes	Alte Art.-Nr. - Old code	1 Stück - Piece
       	Fensterlive Ros. 33x69 abschließbar ohne Rastergehäuse (separat zu notieren*) <i>Dreh Kipp with key on rose mm 33x69 without mechanism (to be ordered separately*)</i>	Chrom - Polished chrome	711-310-10E-000	1A711DKE700005XJA
		Ultra Messing - PVD Gold 	711-310-10E-367	1A711DKE700046XJA
		Fensterlive Ros. 33x69 abschließbar inklusive Rastergehäuse mit 30 mm vorstehendem Stift <i>Dreh Kipp with key on rose mm 33x69 and 7x30 mm spindle (mechanism included)</i>	Chrom - Polished chrome	711-310-00E-000
		Ultra Messing - PVD Gold 	711-310-00E-367	1A711DKE703046XJA
	Fensterlive Ros. 33x69 abschließbar inklusive Reastergehäuse mit 35 mm vorstehendem Stift <i>Dreh Kipp with key on rose mm 33x69 and 7x35 mm spindle (mechanism included)</i>	Chrom - Polished chrome	711-310-20E-000	1A711DKE703505XJA
		Ultra Messing - PVD Gold 	711-310-20E-367	1A711DKE703546XJA

*Rastergehäuse finden Sie auf Seite 172 / For mechanism please see page 172

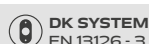

Pure Eckig J26

MESSING - BRASS

Datenblatt
Datasheet

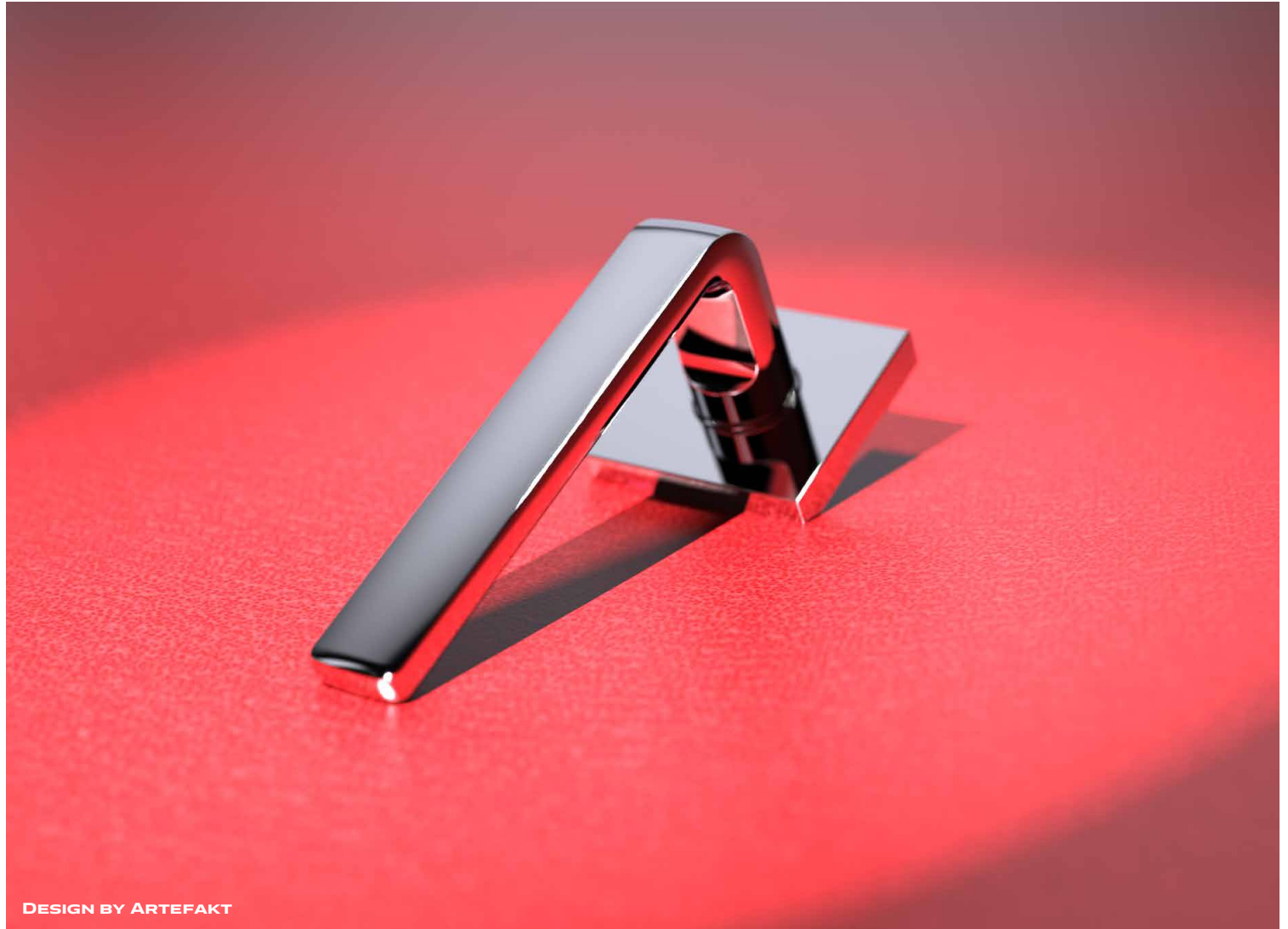

DESIGN BY ARTEFAKT



05
Chrom
Polished chrome



18
Schwarz RAL 9005
Matt black RAL 9005



5S
Edelstahl
Stainless steel 304

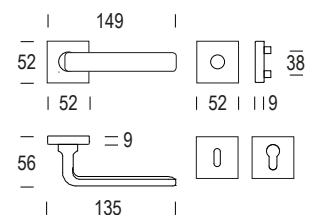

TÜRDRÜCKERGARNITUREN



J26MRJ30



J26MRJ37

WECHSELGARNITUREN



J26PMJ30



J26PMJ38

WC GARNITUREN



J26JRJ30



J26JRJ37

FENSTERGRIFFE



J26DKE82



J26DKC81



J26DKT81

HEBE SCHIEBTÜRGRIF SET



J26MDQ01

Seite 262 / page 262

SCHUTZGARNITUREN



976GF373

Seite 198 / page 198

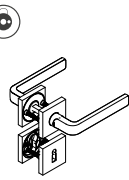
J26MRJ30	Bezeichnung - Description	Farbe - Finishes	Alte Art.-Nr. - Old code	1 Stück - Piece
	Doppelte Bezeichnung 52x52x9 mm Schlüssellochung <i>Pair lever handle on rose 52x52x9 mm key hole</i>	Chrom - Polished chrome	368-371-A00-000	1AJ26MRJ303105EJA
		Schwarz RAL 9005 - Matt black RAL 9005	368-371-A00-180	1AJ26MRJ303118EJA
		Edelstahl - Stainless steel 304	368-371-A00-055	1AJ26MRJ303155EJA
	Doppelte Bezeichnung 52x52x9 mm PZ <i>Pair lever handle on rose 52x52x9 mm euro profile cylinder hole</i>	Chrom - Polished chrome	368-371-B00-000	1AJ26MRJ303205EJA
		Schwarz RAL 9005 - Matt black RAL 9005	368-371-B00-180	1AJ26MRJ303218EJA
		Edelstahl - Stainless steel 304	368-371-B00-055	1AJ26MRJ303255EJA
	WE-Garnitur mit Knopf J03 (373) PZ rechtszeigend <i>Entrance set lever handle / knob J03 (373) Euro profile cylinder hole (right hand)</i>	Chrom - Polished chrome	368-371-D00-000	1AJ26PMJ303205JJA
		Schwarz RAL 9005 - Matt black RAL 9005	368-371-D00-180	1AJ26PMJ303218JJA
		Edelstahl - Stainless steel 304	368-371-D00-057	1AJ26PMJ303255JJA
	WE-Garnitur mit Knopf J03 (373) PZ linkszeigend <i>Entrance set lever handle / knob J03 (373) Euro profile cylinder hole (left hand)</i>	Chrom - Polished chrome	368-371-C00-000	1AJ26PMJ303205LJA
		Schwarz RAL 9005 - Matt black RAL 9005	368-371-C00-180	1AJ26PMJ303218LJA
		Edelstahl - Stainless steel 304	368-371-C00-057	1AJ26PMJ303255SLJA
	WC-Garnitur mit Rosetten 52x52x9 mm mit Riegel & Schlitzschraube <i>Pair lever handle on rose 52x52x9 mm with turn and release</i>	Chrom - Polished chrome	368-371-E00-000	1AJ26JRJ304205EJA
		Schwarz RAL 9005 - Matt black RAL 9005	368-371-E00-180	1AJ26JRJ304218EJA
		Edelstahl - Stainless steel 304	368-371-E00-057	1AJ26JRJ304255EJA

J26MRJ37	Bezeichnung - Description	Farbe - Finishes	Alte Art.-Nr. - Old code	1 Stück - Piece					
	Doppelte Bezeichnung 52x52x9 mm Schlüssellochung Pair lever handle on rose 52x52x9 mm key hole	Chrom - Polished chrome	368-388-A00-000	1AJ26MRJ373105EJA					
		Schwarz RAL 9005 - Matt black RAL 9005	368-388-A00-180	1AJ26MRJ373118EJA					
		Edelstahl - Stainless steel 304	368-388-A00-055	1AJ26MRJ37315SEJA					
	Doppelte Bezeichnung 52x52x9 mm PZ Pair lever handle on rose 52x52x9 mm euro profile cylinder hole	Chrom - Polished chrome	368-388-B00-000	1AJ26MRJ373205EJA					
		Schwarz RAL 9005 - Matt black RAL 9005	368-388-B00-180	1AJ26MRJ373218EJA					
		Edelstahl - Stainless steel 304	368-388-B00-055	1AJ26MRJ37325SEJA					
J26PMJ38	Bezeichnung - Description	Farbe - Finishes	Alte Art.-Nr. - Old code	1 Stück - Piece					
						WE-Garnitur mit Knopf J37 (375) PZ rechtszeigend Entrance set lever handle / knob J37 (375) Euro profile cylinder hole (right hand)	Chrom - Polished chrome	368-388-D00-000	1AJ26PMJ383205JJA
							Schwarz RAL 9005 - Matt black RAL 9005	368-388-D00-180	1AJ26PMJ383218JJA
							Edelstahl - Stainless steel 304	368-388-D00-057	1AJ26PMJ38325SJJJA
	WE-Garnitur mit Knopf J37 (375) PZ linkszeigend Entrance set lever handle / knob J37 (375) Euro profile cylinder hole (left hand)	Chrom - Polished chrome	368-388-C00-000	1AJ26PMJ383205LJA					
		Schwarz RAL 9005 - Matt black RAL 9005	368-388-C00-180	1AJ26PMJ383218LJA					
		Edelstahl - Stainless steel 304	368-388-C00-057	1AJ26PMJ38325SLJA					
J26JRJ37	Bezeichnung - Description	Farbe - Finishes	Alte Art.-Nr. - Old code	1 Stück - Piece					
						WC-Garnitur mit Rosetten 52x52x9 mm mit Riegel & Schlitzschraube Pair lever handle on rose 52x52x9 mm with turn and release	Chrom - Polished chrome	368-388-E00-000	1AJ26JRJ374205EJA
							Schwarz RAL 9005 - Matt black RAL 9005	368-388-E00-180	1AJ26JRJ374218EJA
							Edelstahl - Stainless steel 304	368-388-E00-057	1AJ26JRJ37425SEJA

J26DKE82	Bezeichnung - Description	Farbe - Finishes	Alte Art.-Nr. - Old code	1 Stück - Piece
	Fensterlive rechteckige Ros. 33x70 ohne Rastergehäuse (separat zu notieren*) <i>Dreh Kipp on rose mm 33x70 without mechanism (to be ordered separately*)</i>	Chrom - Polished chrome	368-512-10E-000	1AJ26DKE820005XJA
		Schwarz RAL 9005 - Matt black RAL 9005	368-512-10E-180	1AJ26DKE820018XJA
		Edelstahl - Stainless steel 304	368-512-10E-057	1AJ26DKE82005SXJA
	Fensterlive rechteckige Ros. 33x70 inklusive Rastergehäuse mit 30 mm vorstehendem Stift <i>Dreh Kipp on rose mm 33x70 and 7x30 mm spindle (mechanism included)</i>	Chrom - Polished chrome	368-512-00E-000	1AJ26DKE823005XJA
		Schwarz RAL 9005 - Matt black RAL 9005	368-512-00E-180	1AJ26DKE823018XJA
		Edelstahl - Stainless steel 304	368-512-00E-057	1AJ26DKE82305SXJA
	Fensterlive rechteckige Ros. 33x70 inklusive Reastergehäuse mit 35 mm vorstehendem Stift <i>Dreh Kipp on rose mm 33x70 and 7x35 mm spindle (mechanism included)</i>	Chrom - Polished chrome	368-512-20E-000	1AJ26DKE823505XJA
		Schwarz RAL 9005 - Matt black RAL 9005	368-512-20E-180	1AJ26DKE823518XJA
		Edelstahl - Stainless steel 304	368-512-20E-057	1AJ26DKE82355SXJA

*Rastergehäuse finden Sie auf Seite 172 / For mechanism please see page 172

J26DKC81	Bezeichnung - Description	Farbe - Finishes	Alte Art.-Nr. - Old code	1 Stück - Piece
	Fensterlive "RC 2" zertifiziert Ros. 32x78 ohne Rastergehäuse (separat zu notieren*) <i>DK with key RC2 certified on rose 32x78 without mechanism (to be ordered separately*)</i>	Chrom - Polished chrome	368-C81-10E-000	1AJ26DKC810005XJA
		Schwarz RAL 9005 - Matt black RAL 9005	368-C81-10E-180	1AJ26DKC810018XJA
		Edelstahl - Stainless steel 304	368-C81-10E-055	1AJ26DKC81005SXJA
	Fensterlive "RC 2" zertifiziert Ros. 32x78 inklusive Rastergehäuse mit 30 mm vorstehendem Stift <i>DK with key RC2 certified on rose 32x78 and 7x30 mm spindle (mechanism included)</i>	Chrom - Polished chrome	368-C81-00E-000	1AJ26DKC813005XJA
		Schwarz RAL 9005 - Matt black RAL 9005	368-C81-00E-180	1AJ26DKC813018XJA
		Edelstahl - Stainless steel 304	368-C81-00E-055	1AJ26DKC81305SXJA
	Fensterlive "RC 2" zertifiziert Ros. 32x78 inklusive Reastergehäuse mit 35 mm vorstehendem Stift <i>DK with key RC2 certified on rose 32x78 and 7x35 mm spindle (mechanism included)</i>	Chrom - Polished chrome	368-C81-20E-000	1AJ26DKC813505XJA
		Schwarz RAL 9005 - Matt black RAL 9005	368-C81-20E-180	1AJ26DKC813518XJA
		Edelstahl - Stainless steel 304	368-C81-20E-055	1AJ26DKC81355SXJA

*Rastergehäuse finden Sie auf Seite 172 / For mechanism please see page 172

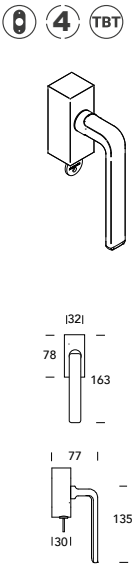
J26DKT81	Bezeichnung - Description	Farbe - Finishes	Alte Art.-Nr. - Old code	1 Stück - Piece
	Fensterolive mit TBT Funktion Ros. 32x78 ohne Rastergehäuse (separat zu notieren*) <i>Dreh Kipp with key on rose 32x78 with TBT function without mechanism (to be ordered separately*)</i>	Chrom - Polished chrome	368-T81-10E-000	1AJ26DKT810005XJA
		Schwarz RAL 9005 - Matt black RAL 9005	368-T81-10E-180	1AJ26DKT810018XJA
		Edelstahl - Stainless steel 304	368-T81-10E-055	1AJ26DKT81005SXJA
	Fensterolive mit TBT Funktion Ros. 32x78 inklusive Rastergehäuse mit 30 mm vorstehendem Stift <i>Dreh Kipp with key on rose 32x78 with TBT function and 7x30 mm spindle (mechanism included)</i>	Chrom - Polished chrome	368-T81-00E-000	1AJ26DKT813005XJA
		Schwarz RAL 9005 - Matt black RAL 9005	368-T81-00E-180	1AJ26DKT813018XJA
		Edelstahl - Stainless steel 304	368-T81-00E-055	1AJ26DKT81305SXJA
	Fensterolive mit TBT Funktion Ros. 32x78 inklusive Reastergehäuse mit 35 mm vorstehendem Stift <i>Dreh Kipp with key on rose 32x78 with TBT function and 7x35 mm spindle (mechanism included)</i>	Chrom - Polished chrome	368-T81-20E-000	1AJ26DKT813505XJA
		Schwarz RAL 9005 - Matt black RAL 9005	368-T81-20E-180	1AJ26DKT813518XJA
		Edelstahl - Stainless steel 304	368-T81-20E-055	1AJ26DKT81355SXJA

*Rastergehäuse finden Sie auf Seite 172 / For mechanism please see page 172

Pure Rund J26

MESSING - BRASS

Datenblatt
Datasheet



DESIGN BY ARTEFAKT



05
Chrom
Polished chrome



18
Schwarz RAL 9005
Matt black RAL 9005



5S
Edelstahl
Stainless steel 304

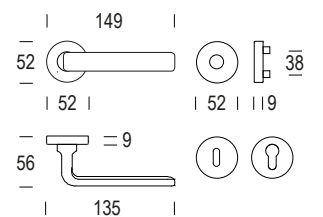

TÜRDRÜCKERGARNITUREN



J26MRJ01

WECHSELGARNITUREN



J26PMJ20

WC GARNITUREN



J26JRJ01

FENSTERGRIFFE



J26DKE66



J26DKC80



J26DKT80

J26MRJ01	Bezeichnung - Description	Farbe - Finishes	Alte Art.-Nr. - Old code	1 Stück - Piece
	Doppelte Bezeichnung Ø52x9 mm Schlüssellochung Pair lever handle on rose Ø52x9 mm key hole	Chrom - Polished chrome	368-373-A00-000	1AJ26MRJ013105EJA
		Schwarz RAL 9005 - Matt black RAL 9005	368-373-A00-180	1AJ26MRJ013118EJA
		Edelstahl - Stainless steel 304	368-373-A00-055	1AJ26MRJ01315SEJA
	Doppelte Bezeichnung Ø52x9 mm PZ Pair lever handle on rose Ø52x9 mm euro profile cylinder hole	Chrom - Polished chrome	368-373-B00-000	1AJ26MRJ013205EJA
		Schwarz RAL 9005 - Matt black RAL 9005	368-373-B00-180	1AJ26MRJ013218EJA
		Edelstahl - Stainless steel 304	368-373-B00-055	1AJ26MRJ01325SEJA
	WE-Garnitur mit Knopf J01 (420) PZ rechtszeigend Entrance set lever handle / knob J01 (420) Euro profile cylinder hole (right hand)	Chrom - Polished chrome	368-373-D00-000	1AJ26PMJ203205JJA
		Schwarz RAL 9005 - Matt black RAL 9005	368-373-D00-180	1AJ26PMJ203218JJA
		Edelstahl - Stainless steel 304	368-373-D00-057	1AJ26PMJ20325SJJJA
	WE-Garnitur mit Knopf J01 (420) PZ linkszeigend Entrance set lever handle / knob J01 (420) Euro profile cylinder hole (left hand)	Chrom - Polished chrome	368-373-C00-000	1AJ26PMJ203205LJA
		Schwarz RAL 9005 - Matt black RAL 9005	368-373-C00-180	1AJ26PMJ203218LJA
		Edelstahl - Stainless steel 304	368-373-C00-057	1AJ26PMJ20325SLJA
	WC-Garnitur mit Rosetten Ø52x9 mm mit Riegel & Schlitzschraube Pair lever handle on rose Ø52x9 mm with turn and release	Chrom - Polished chrome	368-373-E00-000	1AJ26JRJ014205EJA
		Schwarz RAL 9005 - Matt black RAL 9005	368-373-E00-180	1AJ26JRJ014218EJA
		Edelstahl - Stainless steel 304	368-373-E00-057	1AJ26JRJ01425SEJA

FENSTERGRIFFE - WINDOW HANDLES

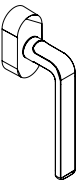
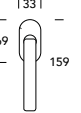
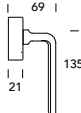
J26DKE66	Bezeichnung - Description	Farbe - Finishes	Alte Art.-Nr. - Old code	1 Stück - Piece
	Fensterlive Ros. 33x69 ohne Rastergehäuse (separat zu notieren*) Dreh Kipp on rose mm 33x69 without mechanism (to be ordered separately*)	Chrom - Polished chrome	368-510-10E-000	1AJ26DKE660005XJA
		Schwarz RAL 9005 - Matt black RAL 9005	368-510-10E-180	1AJ26DKE660018XJA
		Edelstahl - Stainless steel 304	368-510-10E-057	1AJ26DKE66005SXJA
	Fensterlive Ros. 33x69 inklusive Rastergehäuse mit 30 mm vorstehendem Stift Dreh Kipp on rose mm 33x69 and 7x30 mm spindle (mechanism included)	Chrom - Polished chrome	368-510-00E-000	1AJ26DKE663005XJA
		Schwarz RAL 9005 - Matt black RAL 9005	368-510-00E-180	1AJ26DKE663018XJA
		Edelstahl - Stainless steel 304	368-510-00E-057	1AJ26DKE66305SXJA
	Fensterlive Ros. 33x69 inklusive Rastergehäuse mit 35 mm vorstehendem Stift Dreh Kipp on rose mm 33x69 and 7x35 mm spindle (mechanism included)	Chrom - Polished chrome	368-510-20E-000	1AJ26DKE663505XJA
		Schwarz RAL 9005 - Matt black RAL 9005	368-510-20E-180	1AJ26DKE663518XJA
		Edelstahl - Stainless steel 304	368-510-20E-057	1AJ26DKE66355SXJA

*Rastergehäuse finden Sie auf Seite 172 / For mechanism please see page 172

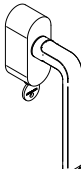
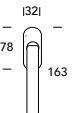
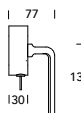
J26DKC80	Bezeichnung - Description	Farbe - Finishes	Alte Art.-Nr. - Old code	1 Stück - Piece
   	Fensterolive "RC 2" zertifiziert Ros. 32x78 ohne Rastergehäuse (separat zu notieren*) <i>DK with key RC2 certified on rose 32x78 without mechanism (to be ordered separately*)</i>	Chrom - Polished chrome Schwarz RAL 9005 - Matt black RAL 9005 Edelstahl - Stainless steel 304	368-C80-10E-000 368-C80-10E-180 368-C80-10E-055	1AJ26DKC800005XJA 1AJ26DKC800018XJA 1AJ26DKC80005SXJA
	Fensterolive "RC 2" zertifiziert Ros. 32x78 inklusive Rastergehäuse mit 30 mm vorstehendem Stift <i>DK with key RC2 certified on rose 32x78 and 7x30 mm spindle (mechanism included)</i>	Chrom - Polished chrome Schwarz RAL 9005 - Matt black RAL 9005 Edelstahl - Stainless steel 304	368-C80-00E-000 368-C80-00E-180 368-C80-00E-055	1AJ26DKC803005XJA 1AJ26DKC803018XJA 1AJ26DKC80305SXJA
	Fensterolive "RC 2" zertifiziert Ros. 32x78 inklusive Rastergehäuse mit 35 mm vorstehendem Stift <i>DK with key RC2 certified on rose 32x78 and 7x35 mm spindle (mechanism included)</i>	Chrom - Polished chrome Schwarz RAL 9005 - Matt black RAL 9005 Edelstahl - Stainless steel 304	368-C80-20E-000 368-C80-20E-180 368-C80-20E-055	1AJ26DKC803505XJA 1AJ26DKC803518XJA 1AJ26DKC80355SXJA

*Rastergehäuse finden Sie auf Seite 172 / For mechanism please see page 172

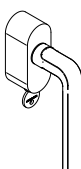
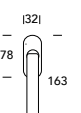
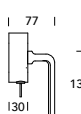
J26DKT80	Bezeichnung - Description	Farbe - Finishes	Alte Art.-Nr. - Old code	1 Stück - Piece
   	Fensterolive mit TBT Funktion Ros. 32x78 ohne Rastergehäuse (separat zu notieren*) <i>Dreh Kipp with key on rose 32x78 with TBT function without mechanism (to be ordered separately*)</i>	Chrom - Polished chrome Schwarz RAL 9005 - Matt black RAL 9005 Edelstahl - Stainless steel 304	368-T80-10E-000 368-T80-10E-180 368-T80-10E-055	1AJ26DKT800005XJA 1AJ26DKT800018XJA 1AJ26DKT80005SXJA
	Fensterolive mit TBT Funktion Ros. 32x78 inklusive Rastergehäuse mit 30 mm vorstehendem Stift <i>Dreh Kipp with key on rose 32x78 with TBT function and 7x30 mm spindle (mechanism included)</i>	Chrom - Polished chrome Schwarz RAL 9005 - Matt black RAL 9005 Edelstahl - Stainless steel 304	368-T80-00E-000 368-T80-00E-180 368-T80-00E-055	1AJ26DKT803005XJA 1AJ26DKT803018XJA 1AJ26DKT80305SXJA
	Fensterolive mit TBT Funktion Ros. 32x78 inklusive Rastergehäuse mit 35 mm vorstehendem Stift <i>Dreh Kipp with key on rose 32x78 with TBT function and 7x35 mm spindle (mechanism included)</i>	Chrom - Polished chrome Schwarz RAL 9005 - Matt black RAL 9005 Edelstahl - Stainless steel 304	368-T80-20E-000 368-T80-20E-180 368-T80-20E-055	1AJ26DKT803505XJA 1AJ26DKT803518XJA 1AJ26DKT80355SXJA

*Rastergehäuse finden Sie auf Seite 172 / For mechanism please see page 172

Sanssouci J18

MESSING - BRASS

Datenblatt
Datasheet



05
Chrom
Polished chrome



46
Ultra Messing
PVD Gold



K1
Nickel Spiegelpoliert Plus
Polished nickel plus

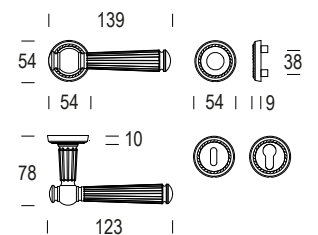
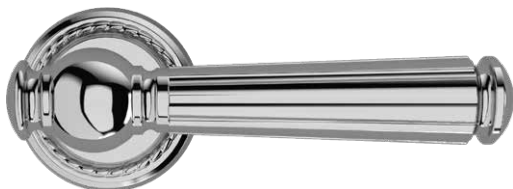

TÜRDRÜCKERGARNITUREN



J18MRJ18



J18MPJ03 *



J18MPJ18 *

WECHSELGARNITUREN



J18PMJ19



J18PMJ13 *



J18PMJ18 *

WC GARNITUREN



J18RJJ18



J18PJJ03 *



J18PJJ18 *

HEBE SCHIEBTÜRGRIFF SET



J18MDC01

Seite 264 / page 264

FENSTERGRIFFE



J18DKE66



J18DKE69



J18DKE70



J18DKC80



J18DKT80



J18SEJ16











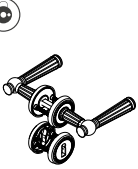

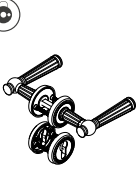

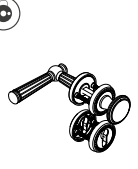

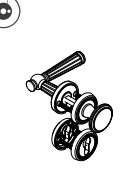

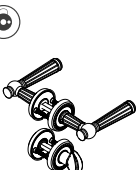

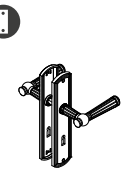
J18MAJ16

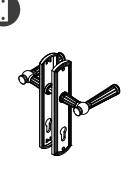

J18TKE69

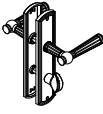
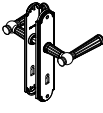
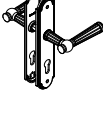

J18MRJ18	Bezeichnung - Description	Farbe - Finishes	Alte Art.-Nr. - Old code	1 Stück - Piece
	Doppelte Bezeichnung Ø54x10 mm Schlüssellochung <i>Pair lever handle on rose Ø54x10 mm key hole</i>	Chrom - Polished chrome	949-992-A00-000	1AJ18MRJ183105EJA
		Ultra Messing - PVD Gold 	949-992-A00-367	1AJ18MRJ183146EJA
		Nickel spiegelpol. Plus - Pol. Nickel Plus 	949-992-A00-004	1AJ18MRJ1831K1EJA
	Doppelte Bezeichnung Ø54x10 mm PZ <i>Pair lever handle on rose Ø54x10 mm euro profile cylinder hole</i>	Chrom - Polished chrome	949-992-B00-000	1AJ18MRJ183205EJA
		Ultra Messing - PVD Gold 	949-992-B00-367	1AJ18MRJ183246EJA
		Nickel spiegelpol. Plus - Pol. Nickel Plus 	949-992-B00-004	1AJ18MRJ1832K1EJA
	WE-Garnitur mit Knopf J02 (922) PZ rechtszeigend <i>Entrance set lever handle / knob J02 (922) Euro profile cylinder hole (right hand)</i>	Chrom - Polished chrome	949-992-D00-000	1AJ18PMJ193205JJA
		Ultra Messing - PVD Gold 	949-992-D00-367	1AJ18PMJ193246JJA
		Nickel spiegelpol. Plus - Pol. Nickel Plus 	949-992-D00-004	1AJ18PMJ1932K1JJA
	WE-Garnitur mit Knopf J02 (922) PZ linkszeigend <i>Entrance set lever handle / knob J02 (922) Euro profile cylinder hole (left hand)</i>	Chrom - Polished chrome	949-992-C00-000	1AJ18PMJ193205LJA
		Ultra Messing - PVD Gold 	949-992-C00-367	1AJ18PMJ193246LJA
		Nickel spiegelpol. Plus - Pol. Nickel Plus 	949-992-C00-004	1AJ18PMJ1932K1LJA
	WC-Garnitur mit Rosetten Ø54x10 mm mit Riegel & Schlitzschraube 8mm VK <i>Pair lever handle on rose Ø54x10 mm with turn and release with 8 mm spindle</i>	Chrom - Polished chrome	949-992-E00-000	1AJ18RJJ184205EJA
		Ultra Messing - PVD Gold 	949-992-E00-367	1AJ18RJJ184246EJA
		Nickel spiegelpol. Plus - Pol. Nickel Plus 	949-992-E00-004	1AJ18RJJ1842K1EJA
	ZT-Garnitur mit Schild 50x228 mm mit BB 72 mm <i>Pair lever handle on plate mm 50x228 with BB key hole 72mm</i>	Chrom - Polished chrome	949-959-100-000	1AJ18MPJ03B605XJA
		Ultra Messing - PVD Gold 	949-959-100-367	1AJ18MPJ03B646XJA
	ZT-Garnitur mit Schild 50x228 mm mit PZ 72 mm <i>Pair lever handle on plate mm 50x228 with Euro Profile cylinder hole 72mm</i>	Chrom - Polished chrome	949-959-200-000	1AJ18MPJ031305XJA
		Ultra Messing - PVD Gold 	949-959-200-367	1AJ18MPJ031346XJA

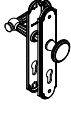
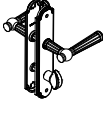
J18PMJ13	Bezeichnung - Description	Farbe - Finishes	Alte Art.-Nr. - Old code	1 Stück - Piece
	WE-Garnitur mit Knopf J02 (922) 72 mm PZ rechtszeigend <i>Entrance set lever handle / knob J02 (922) with Euro Profile cylinder hole 72mm (right hand)</i>	Chrom - Polished chrome	949-959-400-000	1AJ18PMJ131305JJA
		Ultra Messing - PVD Gold	949-959-400-367	1AJ18PMJ131346JJA
	WE-Garnitur mit Knopf J02 (922) 72 mm PZ linkszeigend <i>Entrance set lever handle / knob J02 (922) with Euro Profile cylinder hole 72mm (left hand)</i>	Chrom - Polished chrome	949-959-300-000	1AJ18PMJ131305LJA
		Ultra Messing - PVD Gold	949-959-300-367	1AJ18PMJ131346LJA
	WC-Garnitur 78 mm mit Schild 50x228 mm mit Riegel & Schlitzschraube 8mm VK 8mm VK <i>Pair lever handle on plate mm 50x228 with WC turn and release (8mm WC spindle) distance 78 mm (8mm WC spindle)</i>	Chrom - Polished chrome	949-959-600-000	1AJ18PJJ032405VJA
		Ultra Messing - PVD Gold	949-959-600-367	1AJ18PJJ032446VJA
	ZT-Garnitur mit Schild 50x227 mm mit BB 72 mm <i>Pair lever handle on plate mm 50x227 with BB key hole 72mm</i>	Chrom - Polished chrome	949-990-100-000	1AJ18MPJ18B605XJA
		Ultra Messing - PVD Gold	949-990-100-367	1AJ18MPJ18B646XJA
	ZT-Garnitur mit Schild 50x227 mm mit PZ 72 mm <i>Pair lever handle on plate mm 50x227 with Euro Profile cylinder hole 72mm</i>	Chrom - Polished chrome	949-990-200-000	1AJ18MPJ181305XJA
		Ultra Messing - PVD Gold	949-990-200-367	1AJ18MPJ181346XJA
	WE-Garnitur mit Knopf J02 (922) 72 mm PZ rechtszeigend <i>Entrance set lever handle / knob J02 (922) with Euro Profile cylinder hole 72mm (right hand)</i>	Chrom - Polished chrome	949-990-400-000	1AJ18PMJ181305JJA
		Ultra Messing - PVD Gold	949-990-400-367	1AJ18PMJ181346JJA
	WE-Garnitur mit Knopf J02 (922) 72 mm PZ linkszeigend <i>Entrance set lever handle / knob J02 (922) with Euro Profile cylinder hole 72mm (left hand)</i>	Chrom - Polished chrome	949-990-300-000	1AJ18PMJ181305LJA
		Ultra Messing - PVD Gold	949-990-300-367	1AJ18PMJ181346LJA
	WC-Garnitur mit Schild 50x227 mm mit Riegel & Schlitzschraube 8mm VK <i>Pair lever handle on plate mm 50x227 with WC turn and release (8mm WC spindle)</i>	Chrom - Polished chrome	949-990-600-000	1AJ18PJJ182405VJA
		Ultra Messing - PVD Gold	949-990-600-367	1AJ18PJJ182446VJA

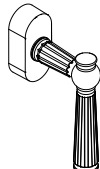
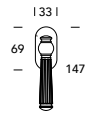
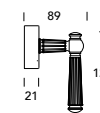
J18DKE66	Bezeichnung - Description	Farbe - Finishes	Alte Art.-Nr. - Old code	1 Stück - Piece
  	Fensterolive Ros. 33x69 ohne Rastergehäuse (separat zu notieren*) <i>Dreh Kipp on rose mm 33x69 without mechanism (to be ordered separately*)</i>	Chrom - Polished chrome	949-510-10E-000	1AJ18DKE660005XJA
		Ultra Messing - PVD Gold	949-510-10E-367	1AJ18DKE660046XJA
		Nickel spiegelpol. Plus - Pol. Nickel Plus	949-510-10E-004	1AJ18DKE6600K1XJA
	Fensterolive Ros. 33x69 inklusive Rastergehäuse mit 30 mm vorstehendem Stift <i>Dreh Kipp on rose mm 33x69 and 7x30 mm spindle (mechanism included)</i>	Chrom - Polished chrome	949-510-00E-000	1AJ18DKE663005XJA
		Ultra Messing - PVD Gold	949-510-00E-367	1AJ18DKE663046XJA
		Nickel spiegelpol. Plus - Pol. Nickel Plus	949-510-00E-004	1AJ18DKE6630K1XJA
	Fensterolive Ros. 33x69 inklusive Reastergehäuse mit 35 mm vorstehendem Stift <i>Dreh Kipp on rose mm 33x69 and 7x35 mm spindle (mechanism included)</i>	Chrom - Polished chrome	949-510-20E-000	1AJ18DKE663505XJA
		Ultra Messing - PVD Gold	949-510-20E-367	1AJ18DKE663546XJA
		Nickel spiegelpol. Plus - Pol. Nickel Plus	949-510-20E-004	1AJ18DKE6635K1XJA

*Rastergehäuse finden Sie auf Seite 172 / For mechanism please see page 172

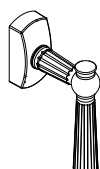
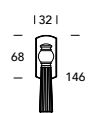
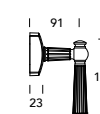
J18DKE69	Bezeichnung - Description	Farbe - Finishes	Alte Art.-Nr. - Old code	1 Stück - Piece
  	Fensterolive Ros. 33x69 ohne Rastergehäuse (separat zu notieren*) <i>Dreh Kipp on rose mm 33x69 without mechanism (to be ordered separately*)</i>	Chrom - Polished chrome	949-410-10E-000	1AJ18DKE690005XJA
		Ultra Messing - PVD Gold	949-410-10E-367	1AJ18DKE690046XJA
		Nickel spiegelpol. Plus - Pol. Nickel Plus	949-410-10E-004	1AJ18DKE6900K1XJA
	Fensterolive Ros. 33x69 inklusive Rastergehäuse mit 30 mm vorstehendem Stift <i>Dreh Kipp on rose mm 33x69 and 7x30 mm spindle (mechanism included)</i>	Chrom - Polished chrome	949-410-00E-000	1AJ18DKE693005XJA
		Ultra Messing - PVD Gold	949-410-00E-367	1AJ18DKE693046XJA
		Nickel spiegelpol. Plus - Pol. Nickel Plus	949-410-00E-004	1AJ18DKE6930K1XJA
	Fensterolive Ros. 33x69 inklusive Reastergehäuse mit 35 mm vorstehendem Stift <i>Dreh Kipp on rose mm 33x69 and 7x35 mm spindle (mechanism included)</i>	Chrom - Polished chrome	949-410-20E-000	1AJ18DKE693505XJA
		Ultra Messing - PVD Gold	949-410-20E-367	1AJ18DKE693546XJA
		Nickel spiegelpol. Plus - Pol. Nickel Plus	949-410-20E-004	1AJ18DKE6935K1XJA

*Rastergehäuse finden Sie auf Seite 172 / For mechanism please see page 172

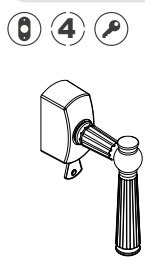
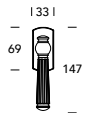
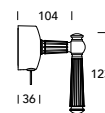
J18DKE70	Bezeichnung - Description	Farbe - Finishes	Alte Art.-Nr. - Old code	1 Stück - Piece	
	Fensterlive Ros. 33x69 abschließbar ohne Rastergehäuse (separat zu notieren*) Dreh Kipp with key on rose mm 33x69 without mechanism (to be ordered separately*)	Chrom - Polished chrome	949-310-10E-000	1AJ18DKE700005XJA	
		Ultra Messing - PVD Gold	949-310-10E-367	1AJ18DKE700046XJA	
		Nickel spiegelpol. Plus - Pol. Nickel Plus	949-310-10E-004	1AJ18DKE7000K1XJA	
		Fensterlive Ros. 33x69 abschließbar inklusive Rastergehäuse mit 30 mm vorstehendem Stift Dreh Kipp with key on rose mm 33x69 and 7x30 mm spindle (mechanism included)	Chrom - Polished chrome	949-310-00E-000	1AJ18DKE703005XJA
			Ultra Messing - PVD Gold	949-310-00E-367	1AJ18DKE703046XJA
			Nickel spiegelpol. Plus - Pol. Nickel Plus	949-310-00E-004	1AJ18DKE7030K1XJA
		Fensterlive Ros. 33x69 abschließbar inklusive Rastergehäuse mit 35 mm vorstehendem Stift Dreh Kipp with key on rose mm 33x69 and 7x35 mm spindle (mechanism included)	Chrom - Polished chrome	949-310-20E-000	1AJ18DKE703505XJA
			Ultra Messing - PVD Gold	949-310-20E-367	1AJ18DKE703546XJA
			Nickel spiegelpol. Plus - Pol. Nickel Plus	949-310-20E-004	1AJ18DKE7035K1XJA

*Rastergehäuse finden Sie auf Seite 172 / For mechanism please see page 172

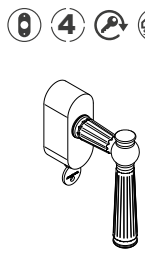
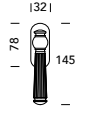
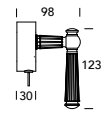
J18DKC80	Bezeichnung - Description	Farbe - Finishes	Alte Art.-Nr. - Old code	1 Stück - Piece	
	Fensterlive "RC 2" zertifiziert Ros. 32x78 ohne Rastergehäuse (separat zu notieren*) DK with key RC2 certified on rose 32x78 without mechanism (to be ordered separately*)	Chrom - Polished chrome	949-C80-10E-000	1AJ18DKC800005XJA	
		Ultra Messing - PVD Gold	949-C80-10E-367	1AJ18DKC800046XJA	
		Nickel spiegelpol. Plus - Pol. Nickel Plus	949-C80-10E-004	1AJ18DKC8000K1XJA	
		Fensterlive "RC 2" zertifiziert Ros. 32x78 inklusive Rastergehäuse mit 30 mm vorstehendem Stift DK with key RC2 certified on rose 32x78 and 7x30 mm spindle (mechanism included)	Chrom - Polished chrome	949-C80-00E-000	1AJ18DKC803005XJA
			Ultra Messing - PVD Gold	949-C80-00E-367	1AJ18DKC803046XJA
			Nickel spiegelpol. Plus - Pol. Nickel Plus	949-C80-00E-004	1AJ18DKC8030K1XJA
		Fensterlive "RC 2" zertifiziert Ros. 32x78 inklusive Rastergehäuse mit 35 mm vorstehendem Stift DK with key RC2 certified on rose 32x78 and 7x35 mm spindle (mechanism included)	Chrom - Polished chrome	949-C80-20E-000	1AJ18DKC803505XJA
			Ultra Messing - PVD Gold	949-C80-20E-367	1AJ18DKC803546XJA
			Nickel spiegelpol. Plus - Pol. Nickel Plus	949-C80-20E-004	1AJ18DKC8035K1XJA

*Rastergehäuse finden Sie auf Seite 172 / For mechanism please see page 172

J18DKT80	Bezeichnung - Description	Farbe - Finishes	Alte Art.-Nr. - Old code	1 Stück - Piece
	Fensterolive mit TBT Funktion Ros. 32x78 ohne Rastergehäuse (separat zu notieren*) <i>Dreh Kipp with key on rose 32x78 with TBT function without mechanism (to be ordered separately*)</i>	Chrom - Polished chrome	949-T80-10E-000	1AJ18DKT800005XJA
		Ultra Messing - PVD Gold	949-T80-10E-367	1AJ18DKT800046XJA
		Nickel spiegelpol. Plus - Pol. Nickel Plus	949-T80-10E-004	1AJ18DKT8000K1XJA
	Fensterolive mit TBT Funktion Ros. 32x78 inklusive Rastergehäuse mit 30 mm vorstehendem Stift <i>Dreh Kipp with key on rose 32x78 with TBT function and 7x30 mm spindle (mechanism included)</i>	Chrom - Polished chrome	949-T80-00E-000	1AJ18DKT803005XJA
		Ultra Messing - PVD Gold	949-T80-00E-367	1AJ18DKT803046XJA
		Nickel spiegelpol. Plus - Pol. Nickel Plus	949-T80-00E-004	1AJ18DKT8030K1XJA
	Fensterolive mit TBT Funktion Ros. 32x78 inklusive Reastergehäuse mit 35 mm vorstehendem Stift <i>Dreh Kipp with key on rose 32x78 with TBT function and 7x35 mm spindle (mechanism included)</i>	Chrom - Polished chrome	949-T80-20E-000	1AJ18DKT803505XJA
		Ultra Messing - PVD Gold	949-T80-20E-367	1AJ18DKT803546XJA
		Nickel spiegelpol. Plus - Pol. Nickel Plus	949-T80-20E-004	1AJ18DKT8035K1XJA

*Rastergehäuse finden Sie auf Seite 172 / For mechanism please see page 172

J18SEJ16	Bezeichnung - Description	Farbe - Finishes	Alte Art.-Nr. - Old code	1 Stück - Piece
	Fensterolive mit ovaler Rosette ohne Rasterung mit 7x30 mm Vorstehendem Stift <i>Window handle without mechanism on oval rose with 7mm spindle</i>	Chrom - Polished chrome	949-000-000-000	1AJ18SEJ165105XJA
		Ultra Messing - PVD Gold	949-000-000-367	1AJ18SEJ165146XJA
		Nickel spiegelpol. Plus - Pol. Nickel Plus	949-000-000-004	1AJ18SEJ1651K1XJA

J18MAJ16	Bezeichnung - Description	Farbe - Finishes	Alte Art.-Nr. - Old code	1 Stück - Piece
	Fensterolive mit ovaler Rosette ohne Rasterung mit 7x30 mm Vorstehendem Stift <i>Window handle without mechanism on oval rose with 7mm spindle</i>	Chrom - Polished chrome	949-T00-000-000	1AJ18MAJ165105XJA
		Ultra Messing - PVD Gold	949-T00-000-367	1AJ18MAJ165146XJA
		Nickel spiegelpol. Plus - Pol. Nickel Plus	949-T00-000-004	1AJ18MAJ1651K1XJA

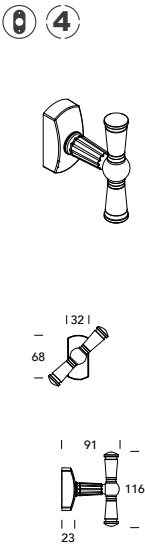
J18TKE69	Bezeichnung - Description	Farbe - Finishes	Alte Art.-Nr. - Old code	1 Stück - Piece
	Fensterolive Ros. 33x69 ohne Rastergehäuse (separat zu notieren*) <i>TK Dreh Kipp T shape on rose mm mm 33x69 without mechanism (to be ordered separately*)</i>	Chrom - Polished chrome	949-T10-1TE-000	1AJ18TKE690005XJA
		Ultra Messing - PVD Gold	949-T10-1TE-367	1AJ18TKE690046XJA
		Nickel spiegelpol. Plus - Pol. Nickel Plus	949-T10-1TE-004	1AJ18TKE6900K1XJA
	Fensterolive Ros. 33x69 inklusive Rastergehäuse mit 30 mm vorstehendem Stift <i>TK Dreh Kipp T shape on rose mm mm 33x69 and 7x30 mm spindle (mechanism included)</i>	Chrom - Polished chrome	949-T10-0TE-000	1AJ18TKE693005XJA
		Ultra Messing - PVD Gold	949-T10-0TE-367	1AJ18TKE693046XJA
		Nickel spiegelpol. Plus - Pol. Nickel Plus	949-T10-0TE-004	1AJ18TKE6930K1XJA
	Fensterolive Ros. 33x69 inklusive Rastergehäuse mit 35 mm vorstehendem Stift <i>TK Dreh Kipp T shape on rose mm mm 33x69 and 7x35 mm spindle (mechanism included)</i>	Chrom - Polished chrome	949-T10-2TE-000	1AJ18TKE693505XJA
		Ultra Messing - PVD Gold	949-T10-2TE-367	1AJ18TKE693546XJA
		Nickel spiegelpol. Plus - Pol. Nickel Plus	949-T10-2TE-004	1AJ18TKE6935K1XJA

*Rastergehäuse finden Sie auf Seite 172 / For mechanism please see page 172

Sanssouci Edelstahl J18

EDELSTAHL - STAINLESS STEEL

Datenblatt
Datasheet



50
Edelstahl Spiegelpoliert
Polished stainless steel



5S
Edelstahl
Stainless steel 304

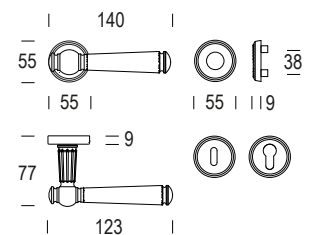

TÜRDRÜCKERGARNITUREN



J18MRJ03

WECHSELGARNITUREN



J18PMJ40

WC GARNITUREN



J18RJJ03

FENSTERGRIFFE



J18DKE66



J18DKE69





J18DKE70



J18DKC80

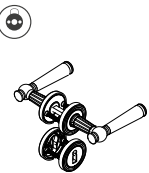
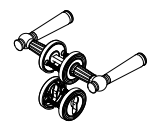
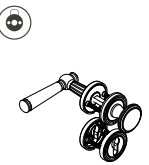

J18DKT80

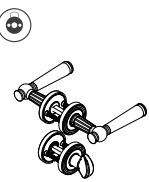
J18MRJ03	Bezeichnung - Description	Farbe - Finishes	Alte Art.-Nr. - Old code	1 Stück - Piece
	Doppelte Bezeichnung Ø55x9 mm Schlüssellochung Pair lever handle on rose Ø55x9 mm key hole	Edelstahl Spiegelpol. - Polished Stainless Steel Edelstahl - Stainless steel 304	949-993-A00-155 949-993-A00-055	1AJ18MRJ033150EJA 1AJ18MRJ03315SEJA
	Doppelte Bezeichnung Ø55x9 mm PZ Pair lever handle on rose Ø55x9 mm euro profile cylinder hole	Edelstahl Spiegelpol. - Polished Stainless Steel Edelstahl - Stainless steel 304	949-993-B00-155 949-993-B00-055	1AJ18MRJ033250EJA 1AJ18MRJ03325SEJA
	WE-Garnitur mit Knopf J02 (922) PZ rechtszeigend Entrance set lever handle / knob J02 (922) Euro profile cylinder hole (right hand)	Edelstahl Spiegelpol. - Polished Stainless Steel Edelstahl - Stainless steel 304	949-993-D00-157 949-993-D00-057	1AJ18PMJ403250JJA 1AJ18PMJ40325SJJA
	WE-Garnitur mit Knopf J02 (922) PZ linkszeigend Entrance set lever handle / knob J02 (922) Euro profile cylinder hole (left hand)	Edelstahl Spiegelpol. - Polished Stainless Steel Edelstahl - Stainless steel 304	949-993-C00-157 949-993-C00-057	1AJ18PMJ403250LJA 1AJ18PMJ40325SLJA
	WC-Garnitur mit Rosetten Ø55x9 mm mit Riegel & Schlitzschraube 8mm VK Pair lever handle on rose Ø55x9 mm with turn and release with 8 mm spindle	Edelstahl Spiegelpol. - Polished Stainless Steel Edelstahl - Stainless steel 304	949-993-E00-157 949-993-E00-057	1AJ18RJJ034250EJA 1AJ18RJJ03425SEJA

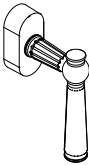
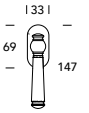
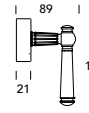
J18DKE66	Bezeichnung - Description	Farbe - Finishes	Alte Art.-Nr. - Old code	1 Stück - Piece
  	Fensterolive Ros. 33x69 ohne Rastergehäuse (separat zu notieren*) <i>Dreh Kipp on rose mm 33x69 without mechanism (to be ordered separately*)</i>	Edelstahl Spiegelpol. - Polished Stainless Steel Edelstahl - Stainless steel 304	949-510-10E-157 949-510-10E-057	1AJ18DKE660050XJA 1AJ18DKE66005SXJA
	Fensterolive Ros. 33x69 inklusive Rastergehäuse mit 30 mm vorstehendem Stift <i>Dreh Kipp on rose mm 33x69 and 7x30 mm spindle (mechanism included)</i>	Edelstahl Spiegelpol. - Polished Stainless Steel Edelstahl - Stainless steel 304	949-510-00E-157 949-510-00E-057	1AJ18DKE663050XJA 1AJ18DKE66305SXJA
	Fensterolive Ros. 33x69 inklusive Reastergehäuse mit 35 mm vorstehendem Stift <i>Dreh Kipp on rose mm 33x69 and 7x35 mm spindle (mechanism included)</i>	Edelstahl Spiegelpol. - Polished Stainless Steel Edelstahl - Stainless steel 304	949-510-20E-157 949-510-20E-057	1AJ18DKE663550XJA 1AJ18DKE66355SXJA

*Rastergehäuse finden Sie auf Seite 172 / For mechanism please see page 172

J18DKE69	Bezeichnung - Description	Farbe - Finishes	Alte Art.-Nr. - Old code	1 Stück - Piece
  	Fensterolive Ros. 33x69 ohne Rastergehäuse (separat zu notieren*) <i>Dreh Kipp on rose mm 33x69 without mechanism (to be ordered separately*)</i>	Edelstahl Spiegelpol. - Polished Stainless Steel Edelstahl - Stainless steel 304	949-410-10E-157 949-410-10E-057	1AJ18DKE690050XJA 1AJ18DKE69005SXJA
	Fensterolive Ros. 33x69 inklusive Rastergehäuse mit 30 mm vorstehendem Stift <i>Dreh Kipp on rose mm 33x69 and 7x30 mm spindle (mechanism included)</i>	Edelstahl Spiegelpol. - Polished Stainless Steel Edelstahl - Stainless steel 304	949-410-00E-157 949-410-00E-057	1AJ18DKE693050XJA 1AJ18DKE69305SXJA
	Fensterolive Ros. 33x69 inklusive Reastergehäuse mit 35 mm vorstehendem Stift <i>Dreh Kipp on rose mm 33x69 and 7x35 mm spindle (mechanism included)</i>	Edelstahl Spiegelpol. - Polished Stainless Steel Edelstahl - Stainless steel 304	949-410-20E-157 949-410-20E-057	1AJ18DKE693550XJA 1AJ18DKE69355SXJA

*Rastergehäuse finden Sie auf Seite 172 / For mechanism please see page 172

J18DKE70	Bezeichnung - Description	Farbe - Finishes	Alte Art.-Nr. - Old code	1 Stück - Piece
     	Fensterlive Ros. 33x69 abschließbar ohne Rastergehäuse (separat zu notieren*) Dreh Kipp with key on rose mm 33x69 without mechanism (to be ordered separately*)	Edelstahl Spiegelpol. - Polished Stainless Steel Edelstahl - Stainless steel 304	949-310-10E-157 949-310-10E-057	1AJ18DKE700050XJA 1AJ18DKE70005SXJA
	Fensterlive Ros. 33x69 abschließbar inklusive Rastergehäuse mit 30 mm vorstehendem Stift Dreh Kipp with key on rose mm 33x69 and 7x30 mm spindle (mechanism included)	Edelstahl Spiegelpol. - Polished Stainless Steel Edelstahl - Stainless steel 304	949-310-00E-157 949-310-00E-057	1AJ18DKE703050XJA 1AJ18DKE70305SXJA
	Fensterlive Ros. 33x69 abschließbar inklusive Rastergehäuse mit 35 mm vorstehendem Stift Dreh Kipp with key on rose mm 33x69 and 7x35 mm spindle (mechanism included)	Edelstahl Spiegelpol. - Polished Stainless Steel Edelstahl - Stainless steel 304	949-310-20E-157 949-310-20E-057	1AJ18DKE703550XJA 1AJ18DKE70355SXJA

*Rastergehäuse finden Sie auf Seite 172 / For mechanism please see page 172

J18DKC80	Bezeichnung - Description	Farbe - Finishes	Alte Art.-Nr. - Old code	1 Stück - Piece
      	Fensterlive "RC 2" zertifiziert Ros. 32x78 ohne Rastergehäuse (separat zu notieren*) DK with key RC2 certified on rose 32x78 without mechanism (to be ordered separately*)	Edelstahl Spiegelpol. - Polished Stainless Steel Edelstahl - Stainless steel 304	949-C80-10E-155 949-C80-10E-055	1AJ18DKC800050XJA 1AJ18DKC80005SXJA
	Fensterlive "RC 2" zertifiziert Ros. 32x78 inklusive Rastergehäuse mit 30 mm vorstehendem Stift DK with key RC2 certified on rose 32x78 and 7x30 mm spindle (mechanism included)	Edelstahl Spiegelpol. - Polished Stainless Steel Edelstahl - Stainless steel 304	949-C80-00E-155 949-C80-00E-055	1AJ18DKC803050XJA 1AJ18DKC80305SXJA
	Fensterlive "RC 2" zertifiziert Ros. 32x78 inklusive Rastergehäuse mit 35 mm vorstehendem Stift DK with key RC2 certified on rose 32x78 and 7x35 mm spindle (mechanism included)	Edelstahl Spiegelpol. - Polished Stainless Steel Edelstahl - Stainless steel 304	949-C80-20E-155 949-C80-20E-055	1AJ18DKC803550XJA 1AJ18DKC80355SXJA

*Rastergehäuse finden Sie auf Seite 172 / For mechanism please see page 172

J18DKT80	Bezeichnung - Description	Farbe - Finishes	Alte Art.-Nr. - Old code	1 Stück - Piece
	Fensterlive mit TBT Funktion Ros. 32x78 ohne Rastergehäuse (separat zu notieren*) <i>Dreh Kipp with key on rose 32x78 with TBT function without mechanism (to be ordered separately*)</i>	Edelstahl Spiegelpol. - Polished Stainless Steel	949-T80-10E-155	1AJ18DKT800050XJA
		Edelstahl - Stainless steel 304	949-T80-10E-055	1AJ18DKT80005SXJA
		Fensterlive mit TBT Funktion Ros. 32x78 inklusive Rastergehäuse mit 30 mm vorstehendem Stift <i>Dreh Kipp with key on rose 32x78 with TBT function and 7x30 mm spindle (mechanism included)</i>	Edelstahl Spiegelpol. - Polished Stainless Steel	949-T80-00E-155
Edelstahl - Stainless steel 304			949-T80-00E-055	1AJ18DKT80305SXJA
	Fensterlive mit TBT Funktion Ros. 32x78 inklusive Rastergehäuse mit 35 mm vorstehendem Stift <i>Dreh Kipp with key on rose 32x78 with TBT function and 7x35 mm spindle (mechanism included)</i>	Edelstahl Spiegelpol. - Polished Stainless Steel	949-T80-20E-155	1AJ18DKT803550XJA
		Edelstahl - Stainless steel 304	949-T80-20E-055	1AJ18DKT80355SXJA

*Rastergehäuse finden Sie auf Seite 172 / For mechanism please see page 172

Sanssouci Porzellan J18

MESSING - BRASS

Datenblatt
Datasheet

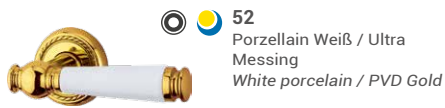

52
Porzellan Weiß / Ultra
Messing
White porcelain / PVD Gold

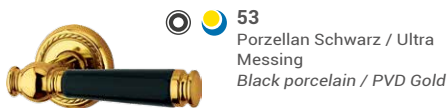

53
Porzellan Schwarz / Ultra
Messing
Black porcelain / PVD Gold

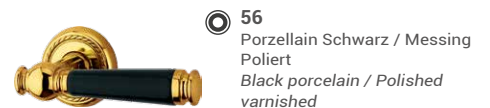

56
Porzellan Schwarz / Messing
Poliert
Black porcelain / Polished
varnished



61
Porzellan Weiß / Messing
Poliert
White porcelain / Polished
varnished

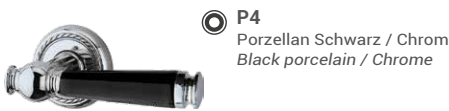

P4
Porzellan Schwarz / Chrom
Black porcelain / Chrome



P6
Porzellan Weiß / Chrom
White porcelain / Chrome

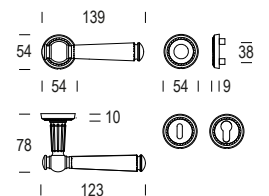

TÜRDRÜCKERGARNITUREN



J18MRJ18



J18MPJ03 *



J18MPJ18

WECHSELGARNITUREN



J18PMJ19



J18PMJ13 *



J18PMJ18

WC GARNITUREN



J18RJJ18



J18PJJ03 *



J18PJJ18

FENSTERGRIFFE



J18DKE66



J18DKE69



J18DKE70











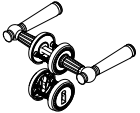

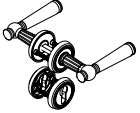

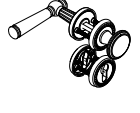





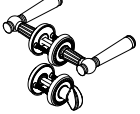



J18DKC80



J18DKT80

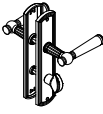
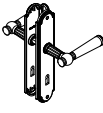
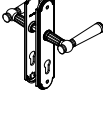
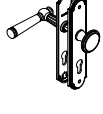

J18MRJ18	Bezeichnung - Description	Farbe - Finishes	Alte Art.-Nr. - Old code	1 Stück - Piece
	Doppelte Bezeichnung Ø54x10 mm Schlüssellochung <i>Pair lever handle on rose Ø54x10 mm key hole</i>	Porz. Weiß/Ultra Messing - White Porc./PVD Gold 	949-992-A00-118	1AJ18MRJ183152EJA
		Porz. Schwarz/Ultra Messing - Black Porc./PVD Gold 	949-992-A00-112	1AJ18MRJ183153EJA
		Porz. Schwarz/Messing Pol. - Black Porc./Pol. Varnished	949-992-A00-012	1AJ18MRJ183156EJA
		Porz. Weiß/Messing Poliert - White porc./Pol. varnished	949-992-A00-018	1AJ18MRJ183161EJA
		Porz. Schwarz/Chrom - Black Porc./Pol. Chrome	949-992-A00-002	1AJ18MRJ1831P4EJA
		Porz. Weiß/Chrom - White Porc./Pol. Chrome	949-992-A00-008	1AJ18MRJ1831P6EJA
	Doppelte Bezeichnung Ø54x10 mm PZ <i>Pair lever handle on rose Ø54x10 mm euro profile cylinder hole</i>	Porz. Weiß/Ultra Messing - White Porc./PVD Gold 	949-992-B00-118	1AJ18MRJ183252EJA
		Porz. Schwarz/Ultra Messing - Black Porc./PVD Gold 	949-992-B00-112	1AJ18MRJ183253EJA
		Porz. Schwarz/Messing Pol. - Black Porc./Pol. Varnished	949-992-B00-012	1AJ18MRJ183256EJA
		Porz. Weiß/Messing Poliert - White porc./Pol. varnished	949-992-B00-018	1AJ18MRJ183261EJA
		Porz. Schwarz/Chrom - Black Porc./Pol. Chrome	949-992-B00-002	1AJ18MRJ1832P4EJA
		Porz. Weiß/Chrom - White Porc./Pol. Chrome	949-992-B00-008	1AJ18MRJ1832P6EJA
	WE-Garnitur mit Knopf J02 (922) PZ rechtszeigend <i>Entrance set lever handle / knob J02 (922) Euro profile cylinder hole (right hand)</i>	Porz. Weiß/Ultra Messing - White Porc./PVD Gold 	949-992-D00-118	1AJ18PMJ193252JJA
		Porz. Schwarz/Ultra Messing - Black Porc./PVD Gold 	949-992-D00-112	1AJ18PMJ193253JJA
		Porz. Schwarz/Messing Pol. - Black Porc./Pol. Varnished	949-992-D00-012	1AJ18PMJ193256JJA
		Porz. Weiß/Messing Poliert - White porc./Pol. varnished	949-992-D00-018	1AJ18PMJ193261JJA
		Porz. Schwarz/Chrom - Black Porc./Pol. Chrome	949-992-D00-002	1AJ18PMJ1932P4JJA
		Porz. Weiß/Chrom - White Porc./Pol. Chrome	949-992-D00-008	1AJ18PMJ1932P6JJA
	WE-Garnitur mit Knopf J02 (922) PZ linkszeigend <i>Entrance set lever handle / knob J02 (922) Euro profile cylinder hole (left hand)</i>	Porz. Weiß/Ultra Messing - White Porc./PVD Gold 	949-992-C00-118	1AJ18PMJ193252LJA
		Porz. Schwarz/Ultra Messing - Black Porc./PVD Gold 	949-992-C00-112	1AJ18PMJ193253LJA
		Porz. Schwarz/Messing Pol. - Black Porc./Pol. Varnished	949-992-C00-012	1AJ18PMJ193256LJA
		Porz. Weiß/Messing Poliert - White porc./Pol. varnished	949-992-C00-018	1AJ18PMJ193261LJA
		Porz. Schwarz/Chrom - Black Porc./Pol. Chrome	949-992-C00-002	1AJ18PMJ1932P4LJA
		Porz. Weiß/Chrom - White Porc./Pol. Chrome	949-992-C00-008	1AJ18PMJ1932P6LJA
	WC-Garnitur mit Rosetten Ø54x10 mm mit Riegel & Schlitzschraube 8mm VK <i>Pair lever handle on rose Ø54x10 mm with turn and release with 8 mm spindle</i>	Porz. Weiß/Ultra Messing - White Porc./PVD Gold 	949-992-E00-118	1AJ18RJJ184252EJA
		Porz. Schwarz/Ultra Messing - Black Porc./PVD Gold 	949-992-E00-112	1AJ18RJJ184253EJA
		Porz. Schwarz/Messing Pol. - Black Porc./Pol. Varnished	949-992-E00-012	1AJ18RJJ184256EJA
		Porz. Weiß/Messing Poliert - White porc./Pol. varnished	949-992-E00-018	1AJ18RJJ184261EJA
		Porz. Schwarz/Chrom - Black Porc./Pol. Chrome	949-992-E00-002	1AJ18RJJ1842P4EJA
		Porz. Weiß/Chrom - White Porc./Pol. Chrome	949-992-E00-008	1AJ18RJJ1842P6EJA
	ZT-Garnitur mit Schild 50x228 mm mit BB 72 mm <i>Pair lever handle on plate mm 50x228 with BB key hole 72mm</i>	Porz. Weiß/Ultra Messing - White Porc./PVD Gold 	949-959-100-118	1AJ18MPJ03B652XJA
		Porz. Schwarz/Ultra Messing - Black Porc./PVD Gold 	949-959-100-112	1AJ18MPJ03B653XJA
		Porz. Schwarz/Messing Pol. - Black Porc./Pol. Varnished	949-959-100-012	1AJ18MPJ03B656XJA
		Porz. Weiß/Messing Poliert - White porc./Pol. varnished	949-959-100-018	1AJ18MPJ03B661XJA
	ZT-Garnitur mit Schild 50x228 mm mit PZ 72 mm <i>Pair lever handle on plate mm 50x228 with Euro Profile cylinder hole 72mm</i>	Porz. Weiß/Ultra Messing - White Porc./PVD Gold 	949-959-200-118	1AJ18MPJ031352XJA
		Porz. Schwarz/Ultra Messing - Black Porc./PVD Gold 	949-959-200-112	1AJ18MPJ031353XJA
		Porz. Schwarz/Messing Pol. - Black Porc./Pol. Varnished	949-959-200-012	1AJ18MPJ031356XJA
		Porz. Weiß/Messing Poliert - White porc./Pol. varnished	949-959-200-018	1AJ18MPJ031361XJA

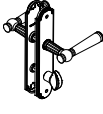
J18PMJ13	Bezeichnung - Description	Farbe - Finishes	Alte Art.-Nr. - Old code	1 Stück - Piece
	WE-Garnitur mit Knopf J02 (922) 72 mm PZ rechtszeigend <i>Entrance set lever handle / knob J02 (922) with Euro Profile cylinder hole 72mm (right hand)</i>	Porz. Weiß/Ultra Messing - White Porc./PVD Gold	949-959-400-118	1AJ18PMJ131352JJA
		Porz. Schwarz/Ultra Messing - Black Porc./PVD Gold	949-959-400-112	1AJ18PMJ131353JJA
		Porz. Schwarz/Messing Pol. - Black Porc./Pol. Varnished	949-959-400-012	1AJ18PMJ131356JJA
		Porz. Weiß/Messing Poliert - White porc./Pol. varnished	949-959-400-018	1AJ18PMJ131361JJA
	WE-Garnitur mit Knopf J02 (922) 72 mm PZ linkszeigend <i>Entrance set lever handle / knob J02 (922) with Euro Profile cylinder hole 72mm (left hand)</i>	Porz. Weiß/Ultra Messing - White Porc./PVD Gold	949-959-300-118	1AJ18PMJ131352LJA
		Porz. Schwarz/Ultra Messing - Black Porc./PVD Gold	949-959-300-112	1AJ18PMJ131353LJA
		Porz. Schwarz/Messing Pol. - Black Porc./Pol. Varnished	949-959-300-012	1AJ18PMJ131356LJA
		Porz. Weiß/Messing Poliert - White porc./Pol. varnished	949-959-300-018	1AJ18PMJ131361LJA
	WC-Garnitur 78 mm mit Schild 50x228 mm mit Riegel & Schlitzschraube 8mm VK 8mm WK <i>Pair lever handle on plate mm 50x228 with WC turn and release (8mm WC spindle) distance 78 mm (8mm WC spindle)</i>	Porz. Weiß/Ultra Messing - White Porc./PVD Gold	949-959-600-118	1AJ18PJ032452VJA
		Porz. Schwarz/Ultra Messing - Black Porc./PVD Gold	949-959-600-112	1AJ18PJ032453VJA
		Porz. Schwarz/Messing Pol. - Black Porc./Pol. Varnished	949-959-600-012	1AJ18PJ032456VJA
		Porz. Weiß/Messing Poliert - White porc./Pol. varnished	949-959-600-018	1AJ18PJ032461VJA
	ZT-Garnitur mit Schild 50x227 mm mit BB 72 mm <i>Pair lever handle on plate mm 50x227 with BB key hole 72mm</i>	Porz. Weiß/Ultra Messing - White Porc./PVD Gold	949-990-100-118	1AJ18MPJ18B652XJA
		Porz. Schwarz/Ultra Messing - Black Porc./PVD Gold	949-990-100-112	1AJ18MPJ18B653XJA
		Porz. Schwarz/Messing Pol. - Black Porc./Pol. Varnished	949-990-100-012	1AJ18MPJ18B656XJA
		Porz. Weiß/Messing Poliert - White porc./Pol. varnished	949-990-100-018	1AJ18MPJ18B661XJA
		Porz. Schwarz/Chrom - Black Porc./Pol. Chrome	949-990-100-002	1AJ18MPJ18B6P4XJA
		Porz. Weiß/Chrom - White Porc./Pol. Chrome	949-990-100-008	1AJ18MPJ18B6P6XJA
	ZT-Garnitur mit Schild 50x227 mm mit PZ 72 mm <i>Pair lever handle on plate mm 50x227 with Euro Profile cylinder hole 72mm</i>	Porz. Weiß/Ultra Messing - White Porc./PVD Gold	949-990-200-118	1AJ18MPJ181352XJA
		Porz. Schwarz/Ultra Messing - Black Porc./PVD Gold	949-990-200-112	1AJ18MPJ181353XJA
		Porz. Schwarz/Messing Pol. - Black Porc./Pol. Varnished	949-990-200-012	1AJ18MPJ181356XJA
		Porz. Weiß/Messing Poliert - White porc./Pol. varnished	949-990-200-018	1AJ18MPJ181361XJA
		Porz. Schwarz/Chrom - Black Porc./Pol. Chrome	949-990-200-002	1AJ18MPJ1813P4XJA
		Porz. Weiß/Chrom - White Porc./Pol. Chrome	949-990-200-008	1AJ18MPJ1813P6XJA
	WE-Garnitur mit Knopf J02 (922) 72 mm PZ rechtszeigend <i>Entrance set lever handle / knob J02 (922) with Euro Profile cylinder hole 72mm (right hand)</i>	Porz. Weiß/Ultra Messing - White Porc./PVD Gold	949-990-400-118	1AJ18PMJ181352JJA
		Porz. Schwarz/Ultra Messing - Black Porc./PVD Gold	949-990-400-112	1AJ18PMJ181353JJA
		Porz. Schwarz/Messing Pol. - Black Porc./Pol. Varnished	949-990-400-012	1AJ18PMJ181356JJA
		Porz. Weiß/Messing Poliert - White porc./Pol. varnished	949-990-400-018	1AJ18PMJ181361JJA
		Porz. Schwarz/Chrom - Black Porc./Pol. Chrome	949-990-400-002	1AJ18PMJ1813P4JJA
		Porz. Weiß/Chrom - White Porc./Pol. Chrome	949-990-400-008	1AJ18PMJ1813P6JJA
	WE-Garnitur mit Knopf J02 (922) 72 mm PZ linkszeigend <i>Entrance set lever handle / knob J02 (922) with Euro Profile cylinder hole 72mm (left hand)</i>	Porz. Weiß/Ultra Messing - White Porc./PVD Gold	949-990-300-118	1AJ18PMJ181352LJA
		Porz. Schwarz/Ultra Messing - Black Porc./PVD Gold	949-990-300-112	1AJ18PMJ181353LJA
		Porz. Schwarz/Messing Pol. - Black Porc./Pol. Varnished	949-990-300-012	1AJ18PMJ181356LJA
		Porz. Weiß/Messing Poliert - White porc./Pol. varnished	949-990-300-018	1AJ18PMJ181361LJA
		Porz. Schwarz/Chrom - Black Porc./Pol. Chrome	949-990-300-002	1AJ18PMJ1813P4LJA
		Porz. Weiß/Chrom - White Porc./Pol. Chrome	949-990-300-008	1AJ18PMJ1813P6LJA
	WC-Garnitur mit Schild 50x227 mm mit Riegel & Schlitzschraube 8mm VK <i>Pair lever handle on plate mm 50x227 with WC turn and release (8mm WC spindle)</i>	Porz. Weiß/Ultra Messing - White Porc./PVD Gold	949-990-600-118	1AJ18PJ182452VJA
		Porz. Schwarz/Ultra Messing - Black Porc./PVD Gold	949-990-600-112	1AJ18PJ182453VJA
		Porz. Schwarz/Messing Pol. - Black Porc./Pol. Varnished	949-990-600-012	1AJ18PJ182456VJA
		Porz. Weiß/Messing Poliert - White porc./Pol. varnished	949-990-600-018	1AJ18PJ182461VJA
		Porz. Schwarz/Chrom - Black Porc./Pol. Chrome	949-990-600-002	1AJ18PJ1824P4VJA
		Porz. Weiß/Chrom - White Porc./Pol. Chrome	949-990-600-008	1AJ18PJ1824P6VJA

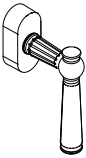
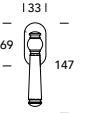
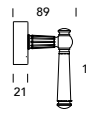
J18DKE66	Bezeichnung - Description	Farbe - Finishes	Alte Art.-Nr. - Old code	1 Stück - Piece
  	Fensterolive Ros. 33x69 ohne Rastergehäuse (separat zu notieren*) Dreh Kipp on rose mm 33x69 without mechanism (to be ordered separately*)	Porz. Weiß/Ultra Messing - White Porc./PVD Gold	949-510-10E-118	1AJ18DKE660052XJA
		Porz. Schwarz/Ultra Messing - Black Porc./PVD Gold	949-510-10E-112	1AJ18DKE660053XJA
		Porz. Schwarz/Messing Pol. - Black Porc./Pol. Varnished	949-510-10E-012	1AJ18DKE660056XJA
		Porz. Weiß/Messing Poliert - White porc./Pol. varnished	949-510-10E-018	1AJ18DKE660061XJA
		Porz. Schwarz/Chrom - Black Porc./Pol. Chrome	949-510-10E-002	1AJ18DKE660064XJA
		Porz. Weiß/Chrom - White Porc./Pol. Chrome	949-510-10E-008	1AJ18DKE660066XJA
	Fensterolive Ros. 33x69 inklusive Rastergehäuse mit 30 mm vorstehendem Stift Dreh Kipp on rose mm 33x69 and 7x30 mm spindle (mechanism included)	Porz. Weiß/Ultra Messing - White Porc./PVD Gold	949-510-00E-118	1AJ18DKE663052XJA
		Porz. Schwarz/Ultra Messing - Black Porc./PVD Gold	949-510-00E-112	1AJ18DKE663053XJA
		Porz. Schwarz/Messing Pol. - Black Porc./Pol. Varnished	949-510-00E-012	1AJ18DKE663056XJA
		Porz. Weiß/Messing Poliert - White porc./Pol. varnished	949-510-00E-018	1AJ18DKE663061XJA
		Porz. Schwarz/Chrom - Black Porc./Pol. Chrome	949-510-00E-002	1AJ18DKE663064XJA
		Porz. Weiß/Chrom - White Porc./Pol. Chrome	949-510-00E-008	1AJ18DKE663066XJA
Fensterolive Ros. 33x69 inklusive Rastergehäuse mit 35 mm vorstehendem Stift Dreh Kipp on rose mm 33x69 and 7x35 mm spindle (mechanism included)	Porz. Weiß/Ultra Messing - White Porc./PVD Gold	949-510-20E-118	1AJ18DKE663552XJA	
	Porz. Schwarz/Ultra Messing - Black Porc./PVD Gold	949-510-20E-112	1AJ18DKE663553XJA	
	Porz. Schwarz/Messing Pol. - Black Porc./Pol. Varnished	949-510-20E-012	1AJ18DKE663556XJA	
	Porz. Weiß/Messing Poliert - White porc./Pol. varnished	949-510-20E-018	1AJ18DKE663561XJA	
	Porz. Schwarz/Chrom - Black Porc./Pol. Chrome	949-510-20E-002	1AJ18DKE663564XJA	
	Porz. Weiß/Chrom - White Porc./Pol. Chrome	949-510-20E-008	1AJ18DKE663566XJA	







*Rastergehäuse finden Sie auf Seite 172 / For mechanism please see page 172

J18DKE69	Bezeichnung - Description	Farbe - Finishes	Alte Art.-Nr. - Old code	1 Stück - Piece
  	Fensterolive Ros. 33x69 ohne Rastergehäuse (separat zu notieren*) Dreh Kipp on rose mm 33x69 without mechanism (to be ordered separately*)	Porz. Weiß/Ultra Messing - White Porc./PVD Gold	949-410-10E-118	1AJ18DKE690052XJA
		Porz. Schwarz/Ultra Messing - Black Porc./PVD Gold	949-410-10E-112	1AJ18DKE690053XJA
		Porz. Schwarz/Messing Pol. - Black Porc./Pol. Varnished	949-410-10E-012	1AJ18DKE690056XJA
		Porz. Weiß/Messing Poliert - White porc./Pol. varnished	949-410-10E-018	1AJ18DKE690061XJA
		Porz. Schwarz/Chrom - Black Porc./Pol. Chrome	949-410-10E-002	1AJ18DKE690064XJA
		Porz. Weiß/Chrom - White Porc./Pol. Chrome	949-410-10E-008	1AJ18DKE690066XJA
	Fensterolive Ros. 33x69 inklusive Rastergehäuse mit 30 mm vorstehendem Stift Dreh Kipp on rose mm 33x69 and 7x30 mm spindle (mechanism included)	Porz. Weiß/Ultra Messing - White Porc./PVD Gold	949-410-00E-118	1AJ18DKE693052XJA
		Porz. Schwarz/Ultra Messing - Black Porc./PVD Gold	949-410-00E-112	1AJ18DKE693053XJA
		Porz. Schwarz/Messing Pol. - Black Porc./Pol. Varnished	949-410-00E-012	1AJ18DKE693056XJA
		Porz. Weiß/Messing Poliert - White porc./Pol. varnished	949-410-00E-018	1AJ18DKE693061XJA
		Porz. Schwarz/Chrom - Black Porc./Pol. Chrome	949-410-00E-002	1AJ18DKE693064XJA
		Porz. Weiß/Chrom - White Porc./Pol. Chrome	949-410-00E-008	1AJ18DKE693066XJA
Fensterolive Ros. 33x69 inklusive Rastergehäuse mit 35 mm vorstehendem Stift Dreh Kipp on rose mm 33x69 and 7x35 mm spindle (mechanism included)	Porz. Weiß/Ultra Messing - White Porc./PVD Gold	949-410-20E-118	1AJ18DKE693552XJA	
	Porz. Schwarz/Ultra Messing - Black Porc./PVD Gold	949-410-20E-112	1AJ18DKE693553XJA	
	Porz. Schwarz/Messing Pol. - Black Porc./Pol. Varnished	949-410-20E-012	1AJ18DKE693556XJA	
	Porz. Weiß/Messing Poliert - White porc./Pol. varnished	949-410-20E-018	1AJ18DKE693561XJA	
	Porz. Schwarz/Chrom - Black Porc./Pol. Chrome	949-410-20E-002	1AJ18DKE693564XJA	
	Porz. Weiß/Chrom - White Porc./Pol. Chrome	949-410-20E-008	1AJ18DKE693566XJA	

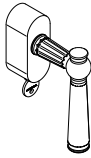
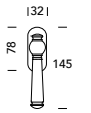
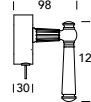







*Rastergehäuse finden Sie auf Seite 172 / For mechanism please see page 172

J18DKE70	Bezeichnung - Description	Farbe - Finishes	Alte Art.-Nr. - Old code	1 Stück - Piece
  	Fensterolive Ros. 33x69 abschließbar ohne Rastergehäuse (separat zu notieren*) Dreh Kipp with key on rose mm 33x69 without mechanism (to be ordered separately*)	Porz. Weiß/Ultra Messing - White Porc./PVD Gold	949-310-10E-118	1AJ18DKE700052XJA
		Porz. Schwarz/Ultra Messing - Black Porc./PVD Gold	949-310-10E-112	1AJ18DKE700053XJA
		Porz. Schwarz/Messing Pol. - Black Porc./Pol. Varnished	949-310-10E-012	1AJ18DKE700056XJA
		Porz. Weiß/Messing Poliert - White porc./Pol. varnished	949-310-10E-018	1AJ18DKE700061XJA
		Porz. Schwarz/Chrom - Black Porc./Pol. Chrome	949-310-10E-002	1AJ18DKE700064XJA
		Porz. Weiß/Chrom - White Porc./Pol. Chrome	949-310-10E-008	1AJ18DKE700066XJA
	Fensterolive Ros. 33x69 abschließbar inklusive Rastergehäuse mit 30 mm vorstehendem Stift Dreh Kipp with key on rose mm 33x69 and 7x30 mm spindle (mechanism included)	Porz. Weiß/Ultra Messing - White Porc./PVD Gold	949-310-00E-118	1AJ18DKE703052XJA
		Porz. Schwarz/Ultra Messing - Black Porc./PVD Gold	949-310-00E-112	1AJ18DKE703053XJA
		Porz. Schwarz/Messing Pol. - Black Porc./Pol. Varnished	949-310-00E-012	1AJ18DKE703056XJA
		Porz. Weiß/Messing Poliert - White porc./Pol. varnished	949-310-00E-018	1AJ18DKE703061XJA
		Porz. Schwarz/Chrom - Black Porc./Pol. Chrome	949-310-00E-002	1AJ18DKE703064XJA
		Porz. Weiß/Chrom - White Porc./Pol. Chrome	949-310-00E-008	1AJ18DKE703066XJA
Fensterolive Ros. 33x69 abschließbar inklusive Rastergehäuse mit 35 mm vorstehendem Stift Dreh Kipp with key on rose mm 33x69 and 7x35 mm spindle (mechanism included)	Porz. Weiß/Ultra Messing - White Porc./PVD Gold	949-310-20E-118	1AJ18DKE703552XJA	
	Porz. Schwarz/Ultra Messing - Black Porc./PVD Gold	949-310-20E-112	1AJ18DKE703553XJA	
	Porz. Schwarz/Messing Pol. - Black Porc./Pol. Varnished	949-310-20E-012	1AJ18DKE703556XJA	
	Porz. Weiß/Messing Poliert - White porc./Pol. varnished	949-310-20E-018	1AJ18DKE703561XJA	
	Porz. Schwarz/Chrom - Black Porc./Pol. Chrome	949-310-20E-002	1AJ18DKE703564XJA	
	Porz. Weiß/Chrom - White Porc./Pol. Chrome	949-310-20E-008	1AJ18DKE703566XJA	

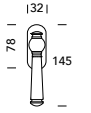
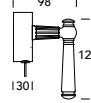
*Rastergehäuse finden Sie auf Seite 172 / For mechanism please see page 172

J18DKC80	Bezeichnung - Description	Farbe - Finishes	Alte Art.-Nr. - Old code	1 Stück - Piece
   	Fensterolive "RC 2" zertifiziert Ros. 32x78 ohne Rastergehäuse (separat zu notieren*) DK with key RC2 certified on rose 32x78 without mechanism (to be ordered separately*)	Porz. Weiß/Ultra Messing - White Porc./PVD Gold 	949-C80-10E-118	1AJ18DKC800052XJA
		Porz. Schwarz/Ultra Messing - Black Porc./PVD Gold 	949-C80-10E-112	1AJ18DKC800053XJA
		Porz. Schwarz/Messing Pol. - Black Porc./Pol. Varnished	949-C80-10E-012	1AJ18DKC800056XJA
		Porz. Weiß/Messing Poliert - White porc./Pol. varnished	949-C80-10E-018	1AJ18DKC800061XJA
		Porz. Schwarz/Chrom - Black Porc./Pol. Chrome	949-C80-10E-002	1AJ18DKC8000P4XJA
		Porz. Weiß/Chrom - White Porc./Pol. Chrome	949-C80-10E-008	1AJ18DKC8000P6XJA
	Fensterolive "RC 2" zertifiziert Ros. 32x78 inklusive Rastergehäuse mit 30 mm vorstehendem Stift DK with key RC2 certified on rose 32x78 and 7x30 mm spindle (mechanism included)	Porz. Weiß/Ultra Messing - White Porc./PVD Gold 	949-C80-00E-118	1AJ18DKC803052XJA
		Porz. Schwarz/Ultra Messing - Black Porc./PVD Gold 	949-C80-00E-112	1AJ18DKC803053XJA
		Porz. Schwarz/Messing Pol. - Black Porc./Pol. Varnished	949-C80-00E-012	1AJ18DKC803056XJA
		Porz. Weiß/Messing Poliert - White porc./Pol. varnished	949-C80-00E-018	1AJ18DKC803061XJA
		Porz. Schwarz/Chrom - Black Porc./Pol. Chrome	949-C80-00E-002	1AJ18DKC8030P4XJA
		Porz. Weiß/Chrom - White Porc./Pol. Chrome	949-C80-00E-008	1AJ18DKC8030P6XJA
Fensterolive "RC 2" zertifiziert Ros. 32x78 inklusive Reastergehäuse mit 35 mm vorstehendem Stift DK with key RC2 certified on rose 32x78 and 7x35 mm spindle (mechanism included)	Porz. Weiß/Ultra Messing - White Porc./PVD Gold 	949-C80-20E-118	1AJ18DKC803552XJA	
	Porz. Schwarz/Ultra Messing - Black Porc./PVD Gold 	949-C80-20E-112	1AJ18DKC803553XJA	
	Porz. Schwarz/Messing Pol. - Black Porc./Pol. Varnished	949-C80-20E-012	1AJ18DKC803556XJA	
	Porz. Weiß/Messing Poliert - White porc./Pol. varnished	949-C80-20E-018	1AJ18DKC803561XJA	
	Porz. Schwarz/Chrom - Black Porc./Pol. Chrome	949-C80-20E-002	1AJ18DKC8035P4XJA	
	Porz. Weiß/Chrom - White Porc./Pol. Chrome	949-C80-20E-008	1AJ18DKC8035P6XJA	

*Rastergehäuse finden Sie auf Seite 172 / For mechanism please see page 172

J18DKT80	Bezeichnung - Description	Farbe - Finishes	Alte Art.-Nr. - Old code	1 Stück - Piece
   	Fensterolive mit TBT Funktion Ros. 32x78 ohne Rastergehäuse (separat zu notieren*) Dreh Kipp with key on rose 32x78 with TBT function without mechanism (to be ordered separately*)	Porz. Weiß/Ultra Messing - White Porc./PVD Gold 	949-T80-10E-118	1AJ18DKT800052XJA
		Porz. Schwarz/Ultra Messing - Black Porc./PVD Gold 	949-T80-10E-112	1AJ18DKT800053XJA
		Porz. Schwarz/Messing Pol. - Black Porc./Pol. Varnished	949-T80-10E-012	1AJ18DKT800056XJA
		Porz. Weiß/Messing Poliert - White porc./Pol. varnished	949-T80-10E-018	1AJ18DKT800061XJA
		Porz. Schwarz/Chrom - Black Porc./Pol. Chrome	949-T80-10E-002	1AJ18DKT8000P4XJA
		Porz. Weiß/Chrom - White Porc./Pol. Chrome	949-T80-10E-008	1AJ18DKT8000P6XJA
	Fensterolive mit TBT Funktion Ros. 32x78 inklusive Rastergehäuse mit 30 mm vorstehendem Stift Dreh Kipp with key on rose 32x78 with TBT function and 7x30 mm spindle (mechanism included)	Porz. Weiß/Ultra Messing - White Porc./PVD Gold 	949-T80-00E-118	1AJ18DKT803052XJA
		Porz. Schwarz/Ultra Messing - Black Porc./PVD Gold 	949-T80-00E-112	1AJ18DKT803053XJA
		Porz. Schwarz/Messing Pol. - Black Porc./Pol. Varnished	949-T80-00E-012	1AJ18DKT803056XJA
		Porz. Weiß/Messing Poliert - White porc./Pol. varnished	949-T80-00E-018	1AJ18DKT803061XJA
		Porz. Schwarz/Chrom - Black Porc./Pol. Chrome	949-T80-00E-002	1AJ18DKT8030P4XJA
		Porz. Weiß/Chrom - White Porc./Pol. Chrome	949-T80-00E-008	1AJ18DKT8030P6XJA
Fensterolive mit TBT Funktion Ros. 32x78 inklusive Reastergehäuse mit 35 mm vorstehendem Stift Dreh Kipp with key on rose 32x78 with TBT function and 7x35 mm spindle (mechanism included)	Porz. Weiß/Ultra Messing - White Porc./PVD Gold 	949-T80-20E-118	1AJ18DKT803552XJA	
	Porz. Schwarz/Ultra Messing - Black Porc./PVD Gold 	949-T80-20E-112	1AJ18DKT803553XJA	
	Porz. Schwarz/Messing Pol. - Black Porc./Pol. Varnished	949-T80-20E-012	1AJ18DKT803556XJA	
	Porz. Weiß/Messing Poliert - White porc./Pol. varnished	949-T80-20E-018	1AJ18DKT803561XJA	
	Porz. Schwarz/Chrom - Black Porc./Pol. Chrome	949-T80-20E-002	1AJ18DKT8035P4XJA	
	Porz. Weiß/Chrom - White Porc./Pol. Chrome	949-T80-20E-008	1AJ18DKT8035P6XJA	

*Rastergehäuse finden Sie auf Seite 172 / For mechanism please see page 172

Schönbrunn J14

MESSING - BRASS

Datenblatt
Datasheet



05
Chrom
Polished chrome



1M
Messing Rustik
Rustic brass



46
Ultra Messing
PVD Gold

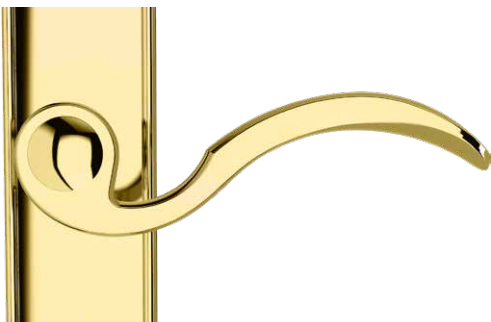

126 JATEC

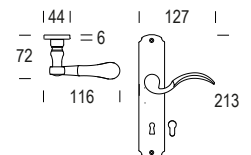

TÜRDRÜCKERGARNITUREN



J14MPJ14



J14MRJ36

WECHSELGARNITUREN



J14PMJ14



J14PMJ36

WC GARNITUREN



J14PJJ14



J14RJJ36

FENSTERGRIFFE



J16TKE66 *













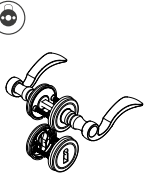

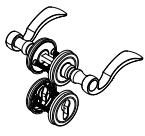

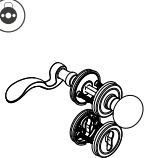
J16TKC80 *



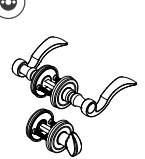

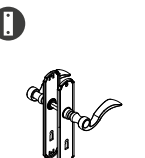

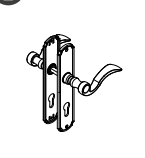

J16TKT80 *





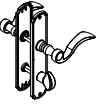



J16MAJ16 *

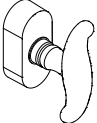

J14MRJ36	Bezeichnung - Description	Farbe - Finishes	Alte Art.-Nr. - Old code	1 Stück - Piece
	Doppelte Bezeichnung Ø55x9 mm Schlüssellochung Pair lever handle on rose Ø55x9 mm key hole	Chrom - Polished chrome	901-428-A00-000	1AJ14MRJ363105EJA
		Messing Rustik - Rustic brass	901-428-A00-01M	1AJ14MRJ36311MEJA
		Ultra Messing - PVD Gold 	901-428-A00-367	1AJ14MRJ363146EJA
	Doppelte Bezeichnung Ø55x9 mm PZ Pair lever handle on rose Ø55x9 mm euro profile cylinder hole	Chrom - Polished chrome	901-428-B00-000	1AJ14MRJ363205EJA
		Messing Rustik - Rustic brass	901-428-B00-01M	1AJ14MRJ36321MEJA
		Ultra Messing - PVD Gold 	901-428-B00-367	1AJ14MRJ363246EJA
	WE-Garnitur mit Knopf J01 (420) PZ rechtszeigend Entrance set lever handle / knob J01 (420) Euro profile cylinder hole (right hand)	Chrom - Polished chrome	901-428-D00-000	1AJ14PMJ363205JJA
		Messing Rustik - Rustic brass	901-428-D00-01M	1AJ14PMJ36321MJJA
		Ultra Messing - PVD Gold 	901-428-D00-367	1AJ14PMJ363246JJA
	WE-Garnitur mit Knopf J01 (420) PZ linkszeigend Entrance set lever handle / knob J01 (420) Euro profile cylinder hole (left hand)	Chrom - Polished chrome	901-428-C00-000	1AJ14PMJ363205LJA
		Messing Rustik - Rustic brass	901-428-C00-01M	1AJ14PMJ36321MLJA
		Ultra Messing - PVD Gold 	901-428-C00-367	1AJ14PMJ363246LJA
	WC-Garnitur mit Rosetten Ø55x9 mm mit Riegel & Schlitzschraube 8mm VK Pair lever handle on rose Ø55x9 mm with turn and release with 8 mm spindle	Chrom - Polished chrome	901-428-E00-000	1AJ14RJJ364205EJA
		Messing Rustik - Rustic brass	901-428-E00-01M	1AJ14RJJ36421MEJA
		Ultra Messing - PVD Gold 	901-428-E00-367	1AJ14RJJ364246EJA
	ZT-Garnitur mit Schild 44x213 mm mit BB 72 mm Pair lever handle on plate mm 44x213 with BB key hole 72mm	Chrom - Polished chrome	901-951-100-000	1AJ14MPJ14B605XJA
		Messing Rustik - Rustic brass	901-951-100-01M	1AJ14MPJ14B61MXJA
		Ultra Messing - PVD Gold 	901-951-100-367	1AJ14MPJ14B646XJA
	ZT-Garnitur mit Schild 44x213 mm mit PZ 72 mm Pair lever handle on plate mm 44x213 with Euro Profile cylinder hole 72mm	Chrom - Polished chrome	901-951-200-000	1AJ14MPJ141305XJA
		Messing Rustik - Rustic brass	901-951-200-01M	1AJ14MPJ14131MXJA
		Ultra Messing - PVD Gold 	901-951-200-367	1AJ14MPJ141346XJA

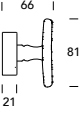
J14PMJ14	Bezeichnung - Description	Farbe - Finishes	Alte Art.-Nr. - Old code	1 Stück - Piece
	WE-Garnitur mit Knopf J02 (922) 72 mm PZ rechtszeigend <i>Entrance set lever handle / knob J02 (922) with Euro Profile cylinder hole 72mm (right hand)</i>	Chrom - Polished chrome	901-951-400-000	1AJ14PMJ141305JJA
		Messing Rustik - Rustic brass	901-951-400-01M	1AJ14PMJ14131MJJA
		Ultra Messing - PVD Gold 	901-951-400-367	1AJ14PMJ141346JJA
	WE-Garnitur mit Knopf J02 (922) 72 mm PZ linkszeigend <i>Entrance set lever handle / knob J02 (922) with Euro Profile cylinder hole 72mm (left hand)</i>	Chrom - Polished chrome	901-951-300-000	1AJ14PMJ141305LJA
		Messing Rustik - Rustic brass	901-951-300-01M	1AJ14PMJ14131MLJA
		Ultra Messing - PVD Gold 	901-951-300-367	1AJ14PMJ141346LJA
	WC-Garnitur mit Schild 44x213 mm mit Riegel & Schlitzschraube 8mm VK <i>Pair lever handle on plate mm 44x213 with WC turn and release (8mm WC spindle)</i>	Chrom - Polished chrome	901-951-600-000	1AJ14PJJ142405VJA
		Messing Rustik - Rustic brass	901-951-600-01M	1AJ14PJJ14241MVJA
		Ultra Messing - PVD Gold 	901-951-600-367	1AJ14PJJ142446VJA

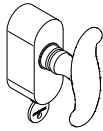

FENSTERGRIFFE - WINDOW HANDLES

J16TKE66	Bezeichnung - Description	Farbe - Finishes	Alte Art.-Nr. - Old code	1 Stück - Piece
	Fensterolive Ros. 33x69 ohne Rastergehäuse (separat zu notieren*) <i>TK Dreh Kipp T shape on rose mm 33x69 without mechanism (to be ordered separately*)</i>	Chrom - Polished chrome	904-610-1TE-000	1AJ16TKE660005XJA
		Ultra Messing - PVD Gold 	904-610-1TE-367	1AJ16TKE660046XJA
	Fensterolive Ros. 33x69 inklusive Rastergehäuse mit 30 mm vorstehendem Stift <i>TK Dreh Kipp T shape on rose mm 33x69 and 7x30 mm spindle (mechanism included)</i>	Chrom - Polished chrome	904-610-0TE-000	1AJ16TKE663005XJA
		Ultra Messing - PVD Gold 	904-610-0TE-367	1AJ16TKE663046XJA
	Fensterolive Ros. 33x69 inklusive Rastergehäuse mit 35 mm vorstehendem Stift <i>TK Dreh Kipp T shape on rose mm 33x69 and 7x35 mm spindle (mechanism included)</i>	Chrom - Polished chrome	904-610-2TE-000	1AJ16TKE663505XJA
		Ultra Messing - PVD Gold 	904-610-2TE-367	1AJ16TKE663546XJA

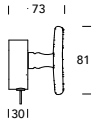
*Rastergehäuse finden Sie auf Seite 172 / For mechanism please see page 172

J16TKC80	Bezeichnung - Description	Farbe - Finishes	Alte Art.-Nr. - Old code	1 Stück - Piece
   	Fensterolive "RC 2" zertifiziert Ros. 32x78 ohne Rastergehäuse (separat zu notieren*) <i>DK T shape with key RC2 certified on rose mm 32x78 without mechanism (to be ordered separately*)</i>	Chrom - Polished chrome Ultra Messing - PVD Gold	904-C80-1TE-000 904-C80-1TE-367	1AJ16TKC800005XJA 1AJ16TKC800046XJA
	Fensterolive "RC 2" zertifiziert Ros. 32x78 inklusive Rastergehäuse mit 30 mm vorstehendem Stift <i>DK T shape with key RC2 certified on rose mm 32x78 and 7x30 mm spindle (mechanism included)</i>	Chrom - Polished chrome Ultra Messing - PVD Gold	904-C80-0TE-000 904-C80-0TE-367	1AJ16TKC803005XJA 1AJ16TKC803046XJA
	Fensterolive "RC 2" zertifiziert Ros. 32x78 inklusive Rastergehäuse mit 35 mm vorstehendem Stift <i>DK T shape with key RC2 certified on rose mm 32x78 and 7x35 mm spindle (mechanism included)</i>	Chrom - Polished chrome Ultra Messing - PVD Gold	904-C80-2TE-000 904-C80-2TE-367	1AJ16TKC803505XJA 1AJ16TKC803546XJA

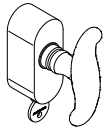
*Rastergehäuse finden Sie auf Seite 172 / For mechanism please see page 172

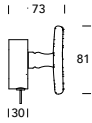
J16TKT80	Bezeichnung - Description	Farbe - Finishes	Alte Art.-Nr. - Old code	1 Stück - Piece
   	Fensterolive mit TBT Funktion Ros. 32x78 ohne Rastergehäuse (separat zu notieren*) <i>TK Dreh Kipp T shape with key on rose mm 32x78 with TBT function without mechanism (to be ordered separately*)</i>	Chrom - Polished chrome Ultra Messing - PVD Gold	904-T80-1TE-000 904-T80-1TE-367	1AJ16TKT800005XJA 1AJ16TKT800046XJA
	Fensterolive mit TBT Funktion Ros. 32x78 inklusive Rastergehäuse mit 30 mm vorstehendem Stift <i>TK Dreh Kipp T shape with key on rose mm 32x78 with TBT function and 7x30 mm spindle (mechanism included)</i>	Chrom - Polished chrome Ultra Messing - PVD Gold	904-T80-0TE-000 904-T80-0TE-367	1AJ16TKT803005XJA 1AJ16TKT803046XJA
	Fensterolive mit TBT Funktion Ros. 32x78 inklusive Rastergehäuse mit 35 mm vorstehendem Stift <i>TK Dreh Kipp T shape with key on rose mm 32x78 with TBT function and 7x35 mm spindle (mechanism included)</i>	Chrom - Polished chrome Ultra Messing - PVD Gold	904-T80-2TE-000 904-T80-2TE-367	1AJ16TKT803505XJA 1AJ16TKT803546XJA

*Rastergehäuse finden Sie auf Seite 172 / For mechanism please see page 172



J16MAJ16	Bezeichnung - Description	Farbe - Finishes	Alte Art.-Nr. - Old code	1 Stück - Piece
  	<p>Fensterlive mit ovaler Rosette ohne Rasterung mit 7x30 mm Vorstehendem Stift</p>	<p>Chrom - Polished chrome Ultra Messing - PVD Gold </p>	<p>904-000-000-000 904-000-000-367</p>	<p>1AJ16MAJ165105XJA 1AJ16MAJ165146XJA</p>







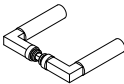











JATEC





EINZELTEILE
COMPLEMENTS

	Bezeichnung - Description	Farbe - Finishes	Alte Art.-Nr. - Old code	1 Stück - Piece
	ZT - Drückerpaar mit 8mm VK Pair Handles without roses with 8mm spindle	Chrom - Polished chrome	402-718-000-000	1AJ04CMXXX5205CJA
		Schwarz RAL 9005 - Matt black RAL 9005	402-718-000-180	1AJ04CMXXX5218CJA
		Ultra Messing - PVD Gold	402-718-000-367	1AJ04CMXXX5246CJA
		Edelstahl - Stainless steel 304	402-718-000-055	1AJ04CMXXX5255CJA
		Nickel spiegelpol. Plus - Pol. Nickel Plus	402-718-000-004	1AJ04CMXXX52K1CJA
	Drückerlochteil rechts mit Madenschraube Right handle only with grub screw hole in lower position	Chrom - Polished chrome	402-718-400-000	1AJ04ID0065805CJA
		Schwarz RAL 9005 - Matt black RAL 9005	402-718-400-180	1AJ04ID0065818CJA
		Ultra Messing - PVD Gold	402-718-400-367	1AJ04ID0065846CJA
		Nickel spiegelpol. Plus - Pol. Nickel Plus	402-718-400-004	1AJ04ID00658K1CJA
	Drückerlochteil links mit Madenschraube Left handle only with grub screw hole in lower position	Chrom - Polished chrome	402-718-300-000	1AJ04IS0065805CJA
		Schwarz RAL 9005 - Matt black RAL 9005	402-718-300-180	1AJ04IS0065818CJA
		Ultra Messing - PVD Gold	402-718-300-367	1AJ04IS0065846CJA
		Nickel spiegelpol. Plus - Pol. Nickel Plus	402-718-300-004	1AJ04IS00658K1CJA
	Drückerlochteil links und rechts verwendbar mit Madenschraube intern Handle only with grub screw hole in internal position	Chrom - Polished chrome	402-708-500-000	1AJ04IPI065805CJA
		Schwarz RAL 9005 - Matt black RAL 9005	402-708-500-180	1AJ04IPI065818CJA
		Ultra Messing - PVD Gold	402-708-500-367	1AJ04IPI065846CJA
		Edelstahl - Stainless steel 304	402-708-500-055	1AJ04IPI065855CJA
		Nickel spiegelpol. Plus - Pol. Nickel Plus	402-708-500-004	1AJ04IPI0658K1CJA



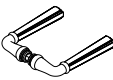

Belle Epoque



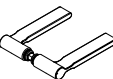

	Bezeichnung - Description	Farbe - Finishes	Alte Art.-Nr. - Old code	1 Stück - Piece
	ZT - Drückerpaar mit 8mm VK Pair Handles without roses with 8mm spindle	Chrom - Polished chrome	933-718-000-000	1AJ12CMXXX5205CJA
		Ultra Messing - PVD Gold	933-718-000-367	1AJ12CMXXX5246CJA
		Antik Nickel - Antique Nickel	933-718-000-444	1AJ12CMXXX528BCJA
	Drückerlochteil rechts mit Madenschraube Right handle only with grub screw hole in lower position	Chrom - Polished chrome	933-718-400-000	1AJ12ID0065805CJA
		Ultra Messing - PVD Gold	933-718-400-367	1AJ12ID0065846CJA
		Antik Nickel - Antique Nickel	933-718-400-444	1AJ12ID006588BCJA
	Drückerlochteil links mit Madenschraube Left handle only with grub screw hole in lower position	Chrom - Polished chrome	933-718-300-000	1AJ12IS0065805CJA
		Ultra Messing - PVD Gold	933-718-300-367	1AJ12IS0065846CJA
		Antik Nickel - Antique Nickel	933-718-300-444	1AJ12IS006588BCJA
	Drückerlochteil links und rechts verwendbar mit Madenschraube intern Handle only with grub screw hole in internal position	Chrom - Polished chrome	933-708-500-000	1AJ12IPI065805CJA
		Ultra Messing - PVD Gold	933-708-500-367	1AJ12IPI065846CJA
		Antik Nickel - Antique Nickel	933-708-500-444	1AJ12IPI06588BCJA

	Bezeichnung - Description	Farbe - Finishes	Alte Art.-Nr. - Old code	1 Stück - Piece
	ZT - Drückerpaar mit 8mm VK <i>Pair Handles without roses with 8mm spindle</i>	Ultra Messing - PVD Gold 	908-718-000-367	1AJ16CMXX5246CJA
	Drückerlochteil rechts mit Madenschraube <i>Right handle only with grub screw hole in lower position</i>	Ultra Messing - PVD Gold 	908-718-400-367	1AJ16ID0065846CJA
	Drückerlochteil rechts mit Madenschraube intern <i>Right handle only with grub screw hole in internal position</i>	Ultra Messing - PVD Gold 	908-708-400-367	1AJ16IDI065846CJA
	Drückerlochteil links mit Madenschraube <i>Left handle only with grub screw hole in lower position</i>	Ultra Messing - PVD Gold 	908-718-300-367	1AJ16IS0065846CJA
	Drückerlochteil links mit Madenschraube intern <i>Left handle only with grub screw hole in internal position</i>	Ultra Messing - PVD Gold 	908-708-300-367	1AJ16ISI065846CJA

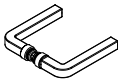

	Bezeichnung - Description	Farbe - Finishes	Alte Art.-Nr. - Old code	1 Stück - Piece
 <p>ZT - Drückerpaar mit 8mm VK <i>Pair Handles without roses with 8mm spindle</i></p>		Chrom - Polished chrome	900-718-000-000	1AJ03CMXXX5205CJA
		Ultra Messing - PVD Gold	900-718-000-367	1AJ03CMXXX5246CJA
		Antik Nickel - Antique Nickel	900-718-000-444	1AJ03CMXXX528BCJA
		Ultra Mattnickel - PVD Satin inox	900-718-000-066	1AJ03CMXXX5298CJA
 <p>Drückerlochteil rechts mit Madenschraube <i>Right handle only with grub screw hole in lower position</i></p>		Chrom - Polished chrome	900-718-400-000	1AJ03ID0065805CJA
		Ultra Messing - PVD Gold	900-718-400-367	1AJ03ID0065846CJA
		Antik Nickel - Antique Nickel	900-718-400-444	1AJ03ID006588BCJA
		Ultra Mattnickel - PVD Satin inox	900-718-400-066	1AJ03ID0065898CJA
 <p>Drückerlochteil links mit Madenschraube <i>Left handle only with grub screw hole in lower position</i></p>		Chrom - Polished chrome	900-718-300-000	1AJ03IS0065805CJA
		Ultra Messing - PVD Gold	900-718-300-367	1AJ03IS0065846CJA
		Antik Nickel - Antique Nickel	900-718-300-444	1AJ03IS006588BCJA
		Ultra Mattnickel - PVD Satin inox	900-718-300-066	1AJ03IS0065898CJA
 <p>Drückerlochteil links und rechts verwendbar mit Madenschraube intern <i>Handle only with grub screw hole in internal position</i></p>		Chrom - Polished chrome	900-708-500-000	1AJ03IPI065805CJA
		Ultra Messing - PVD Gold	900-708-500-367	1AJ03IPI065846CJA
		Antik Nickel - Antique Nickel	900-708-500-444	1AJ03IPI06588BCJA
		Ultra Mattnickel - PVD Satin inox	900-708-500-066	1AJ03IPI065898CJA





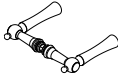

ID-9

	Bezeichnung - Description	Farbe - Finishes	Alte Art.-Nr. - Old code	1 Stück - Piece
 <p>ZT - Drückerpaar mit 8mm VK <i>Pair Handles without roses with 8mm spindle</i></p>		Chrom - Polished chrome	377-718-000-000	1AJ37CMXXX5205CJA
		Schwarz RAL 9005 - Matt black RAL 9005	377-718-000-180	1AJ37CMXXX5218CJA
		Edelstahl - Stainless steel 304	377-718-000-055	1AJ37CMXXX525SCJA
 <p>Drückerlochteil rechts mit Madenschraube <i>Right handle only with grub screw hole in lower position</i></p>		Chrom - Polished chrome	377-718-400-000	1AJ37ID0065805CJA
		Schwarz RAL 9005 - Matt black RAL 9005	377-718-400-180	1AJ37ID0065818CJA
 <p>Drückerlochteil links mit Madenschraube <i>Left handle only with grub screw hole in lower position</i></p>		Chrom - Polished chrome	377-718-300-000	1AJ37IS0065805CJA
		Schwarz RAL 9005 - Matt black RAL 9005	377-718-300-180	1AJ37IS0065818CJA
 <p>Drückerlochteil links und rechts verwendbar mit Madenschraube intern <i>Handle only with grub screw hole in internal position</i></p>		Chrom - Polished chrome	377-708-500-000	1AJ37IPI065805CJA
		Schwarz RAL 9005 - Matt black RAL 9005	377-708-500-180	1AJ37IPI065818CJA
		Edelstahl - Stainless steel 304	377-708-500-055	1AJ37IPI06585SCJA

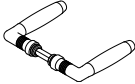
	Bezeichnung - Description	Farbe - Finishes	Alte Art.-Nr. - Old code	1 Stück - Piece
	ZT - Drückerpaar mit 8mm VK Pair Handles without roses with 8mm spindle	Chrom - Polished chrome	373-718-000-000	1AJ27CMXXX5205CJA
		Schwarz RAL 9005 - Matt black RAL 9005	373-718-000-180	1AJ27CMXXX5218CJA
	Drückerlochteil rechts mit Madenschraube Right handle only with grub screw hole in lower position	Chrom - Polished chrome	373-718-400-000	1AJ27ID0065805CJA
		Schwarz RAL 9005 - Matt black RAL 9005	373-718-400-180	1AJ27ID0065818CJA
	Drückerlochteil links mit Madenschraube Left handle only with grub screw hole in lower position	Chrom - Polished chrome	373-718-300-000	1AJ27IS0065805CJA
		Schwarz RAL 9005 - Matt black RAL 9005	373-718-300-180	1AJ27IS0065818CJA
	Drückerlochteil links und rechts verwendbar mit Madenschraube intern Handle only with grub screw hole in internal position	Chrom - Polished chrome	373-708-500-000	1AJ27IPI065805CJA
		Schwarz RAL 9005 - Matt black RAL 9005	373-708-500-180	1AJ27IPI065818CJA





Lighthouse

	Bezeichnung - Description	Farbe - Finishes	Alte Art.-Nr. - Old code	1 Stück - Piece
	ZT - Drückerpaar mit 8mm VK Pair Handles without roses with 8mm spindle	Chrom - Polished chrome	428-718-000-000	1AJ36CMXXX5205CJA
		Ultra Messing - PVD Gold	428-718-000-367	1AJ36CMXXX5246CJA
		Antik Nickel - Antique Nickel	428-718-000-444	1AJ36CMXXX528BCJA
		Ultra Mattnickel - PVD Satin inox	428-718-000-066	1AJ36CMXXX5298CJA
	Drückerlochteil rechts mit Madenschraube Right handle only with grub screw hole in lower position	Chrom - Polished chrome	428-718-400-000	1AJ36ID0065805CJA
		Ultra Messing - PVD Gold	428-718-400-367	1AJ36ID0065846CJA
		Antik Nickel - Antique Nickel	428-718-400-444	1AJ36ID006588BCJA
		Ultra Mattnickel - PVD Satin inox	428-718-400-066	1AJ36ID0065898CJA
	Drückerlochteil links mit Madenschraube Left handle only with grub screw hole in lower position	Chrom - Polished chrome	428-718-300-000	1AJ36IS0065805CJA
		Ultra Messing - PVD Gold	428-718-300-367	1AJ36IS0065846CJA
		Antik Nickel - Antique Nickel	428-718-300-444	1AJ36IS006588BCJA
		Ultra Mattnickel - PVD Satin inox	428-718-300-066	1AJ36IS0065898CJA
	Drückerlochteil links und rechts verwendbar mit Madenschraube intern Handle only with grub screw hole in internal position	Chrom - Polished chrome	428-708-500-000	1AJ36IPI065805CJA
		Ultra Messing - PVD Gold	428-708-500-367	1AJ36IPI065846CJA
		Antik Nickel - Antique Nickel	428-708-500-444	1AJ36IPI06588BCJA
		Ultra Mattnickel - PVD Satin inox	428-708-500-066	1AJ36IPI065898CJA



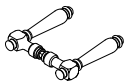

	Bezeichnung - Description	Farbe - Finishes	Alte Art.-Nr. - Old code	1 Stück - Piece
	ZT - Drückerpaar mit 8mm VK <i>Pair Handles without roses with 8mm spindle</i>	Ultra Mattnic./Holz Schwarz - Dark wood/PVD Sat. inox 	417-718-000-280	1AJ35CMXXX526PCJA
		Chrom/Holz Schwarz - Dark Wood/Polished chrome	417-718-000-002	1AJ35CMXXX52L6CJA
	Drückerlochteil rechts mit Madenschraube <i>Right handle only with grub screw hole in lower position</i>	Ultra Mattnic./Holz Schwarz - Dark wood/PVD Sat. inox 	417-718-400-280	1AJ35ID006586PCJA
		Chrom/Holz Schwarz - Dark Wood/Polished chrome	417-718-400-002	1AJ35ID00658L6CJA
	Drückerlochteil links mit Madenschraube <i>Left handle only with grub screw hole in lower position</i>	Ultra Mattnic./Holz Schwarz - Dark wood/PVD Sat. inox 	417-718-300-280	1AJ35IS006586PCJA
		Chrom/Holz Schwarz - Dark Wood/Polished chrome	417-718-300-002	1AJ35IS00658L6CJA
	Drückerlochteil links und rechts verwendbar mit Madenschraube intern <i>Handle only with grub screw hole in internal position</i>	Ultra Mattnic./Holz Schwarz - Dark wood/PVD Sat. inox 	417-708-500-280	1AJ35IPI06586PCJA
		Chrom/Holz Schwarz - Dark Wood/Polished chrome	417-708-500-002	1AJ35IPI0658L6CJA



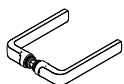

Montparnasse

	Bezeichnung - Description	Farbe - Finishes	Alte Art.-Nr. - Old code	1 Stück - Piece
	ZT - Drückerpaar mit 8mm VK <i>Pair Handles without roses with 8mm spindle</i>	Chrom - Polished chrome	416-718-000-000	1AJ01CMXXX5205CJA
		Ultra Messing - PVD Gold 	416-718-000-367	1AJ01CMXXX5246CJA
		Edelstahl - Stainless steel 304	416-718-000-055	1AJ01CMXXX5255CJA
		Ultra Mattnickel - PVD Satin inox 	416-718-000-066	1AJ01CMXXX5298CJA
	Drückerlochteil rechts mit Madenschraube <i>Right handle only with grub screw hole in lower position</i>	Chrom - Polished chrome	416-718-400-000	1AJ01ID0065805CJA
		Ultra Messing - PVD Gold 	416-718-400-367	1AJ01ID0065846CJA
		Edelstahl - Stainless steel 304	416-718-400-055	1AJ01ID0065855CJA
		Ultra Mattnickel - PVD Satin inox 	416-718-400-066	1AJ01ID0065898CJA
	Drückerlochteil links mit Madenschraube <i>Left handle only with grub screw hole in lower position</i>	Chrom - Polished chrome	416-718-300-000	1AJ01IS0065805CJA
		Ultra Messing - PVD Gold 	416-718-300-367	1AJ01IS0065846CJA
		Edelstahl - Stainless steel 304	416-718-300-055	1AJ01IS0065855CJA
		Ultra Mattnickel - PVD Satin inox 	416-718-300-066	1AJ01IS0065898CJA
	Drückerlochteil links und rechts verwendbar mit Madenschraube intern <i>Handle only with grub screw hole in internal position</i>	Chrom - Polished chrome	416-708-500-000	1AJ01IPI065805CJA
		Ultra Messing - PVD Gold 	416-708-500-367	1AJ01IPI065846CJA
		Edelstahl - Stainless steel 304	416-708-500-055	1AJ01IPI065855CJA
		Ultra Mattnickel - PVD Satin inox 	416-708-500-066	1AJ01IPI065898CJA



	Bezeichnung - Description	Farbe - Finishes	Alte Art.-Nr. - Old code	1 Stück - Piece
	ZT - Drückerpaar mit 8mm VK Pair Handles without roses with 8mm spindle	Chrom - Polished chrome	711-718-000-000	1A711CMXXX5205CJA
		Ultra Messing - PVD Gold	711-718-000-367	1A711CMXXX5246CJA
	Drückerlochteil rechts mit Madenschraube Right handle only with grub screw hole in lower position	Chrom - Polished chrome	711-718-400-000	1A711ID0065805CJA
		Ultra Messing - PVD Gold	711-718-400-367	1A711ID0065846CJA
	Drückerlochteil links mit Madenschraube Left handle only with grub screw hole in lower position	Chrom - Polished chrome	711-718-300-000	1A711IS0065805CJA
		Ultra Messing - PVD Gold	711-718-300-367	1A711IS0065846CJA
	Drückerlochteil links und rechts verwendbar mit Madenschraube intern Handle only with grub screw hole in internal position	Chrom - Polished chrome	711-708-500-000	1A711IPI065805CJA
		Ultra Messing - PVD Gold	711-708-500-367	1A711IPI065846CJA







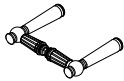



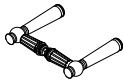

Pure

	Bezeichnung - Description	Farbe - Finishes	Alte Art.-Nr. - Old code	1 Stück - Piece
	ZT - Drückerpaar mit 8mm VK Pair Handles without roses with 8mm spindle	Chrom - Polished chrome	368-718-000-000	1AJ26CMXXX5205CJA
		Schwarz RAL 9005 - Matt black RAL 9005	368-718-000-180	1AJ26CMXXX5218CJA
		Edelstahl - Stainless steel 304	368-718-000-055	1AJ26CMXXX5255CJA
	Drückerlochteil rechts mit Madenschraube Right handle only with grub screw hole in lower position	Chrom - Polished chrome	368-718-400-000	1AJ26ID0065805CJA
		Schwarz RAL 9005 - Matt black RAL 9005	368-718-400-180	1AJ26ID0065818CJA
		Edelstahl - Stainless steel 304	368-718-400-055	1AJ26ID0065855CJA
	Drückerlochteil links mit Madenschraube Left handle only with grub screw hole in lower position	Chrom - Polished chrome	368-718-300-000	1AJ26IS0065805CJA
		Schwarz RAL 9005 - Matt black RAL 9005	368-718-300-180	1AJ26IS0065818CJA
		Edelstahl - Stainless steel 304	368-718-300-055	1AJ26IS0065855CJA
	Drückerlochteil links und rechts verwendbar mit Madenschraube intern Handle only with grub screw hole in internal position	Chrom - Polished chrome	368-708-500-000	1AJ26IPI065805CJA
		Schwarz RAL 9005 - Matt black RAL 9005	368-708-500-180	1AJ26IPI065818CJA
		Edelstahl - Stainless steel 304	368-708-500-055	1AJ26IPI065855CJA







	Bezeichnung - Description	Farbe - Finishes	Alte Art.-Nr. - Old code	1 Stück - Piece
	ZT - Drückerpaar mit 8mm VK <i>Pair Handles without roses with 8mm spindle</i>	Chrom - Polished chrome	949-718-000-000	1AJ18CMXXX5205CJA
		Ultra Messing - PVD Gold	949-718-000-367	1AJ18CMXXX5246CJA
		Nickel spiegelpol. Plus - Pol. Nickel Plus	949-718-000-004	1AJ18CMXXX52K1CJA
	Drückerlochteil rechts mit Madenschraube <i>Right handle only with grub screw hole in lower position</i>	Chrom - Polished chrome	949-718-400-000	1AJ18ID0065805CJA
		Ultra Messing - PVD Gold	949-718-400-367	1AJ18ID0065846CJA
		Nickel spiegelpol. Plus - Pol. Nickel Plus	949-718-400-004	1AJ18ID00658K1CJA
	Drückerlochteil links mit Madenschraube <i>Left handle only with grub screw hole in lower position</i>	Chrom - Polished chrome	949-718-300-000	1AJ18IS0065805CJA
		Ultra Messing - PVD Gold	949-718-300-367	1AJ18IS0065846CJA
		Nickel spiegelpol. Plus - Pol. Nickel Plus	949-718-300-004	1AJ18IS00658K1CJA
	Drückerlochteil links und rechts verwendbar mit Madenschraube intern <i>Handle only with grub screw hole in internal position</i>	Chrom - Polished chrome	949-708-500-000	1AJ18IPI065805CJA
		Ultra Messing - PVD Gold	949-708-500-367	1AJ18IPI065846CJA
		Nickel spiegelpol. Plus - Pol. Nickel Plus	949-708-500-004	1AJ18IPI0658K1CJA

Sanssouci Edelstahl



	Bezeichnung - Description	Farbe - Finishes	Alte Art.-Nr. - Old code	1 Stück - Piece
	ZT - Drückerpaar mit 8mm VK <i>Pair Handles without roses with 8mm spindle</i>	Edelstahl - Stainless steel 304	949-718-000-055	1AJ18CMXXX525SCJA
		Edelstahl Spiegelpol. - Polished Stainless Steel	-	1AJ18CMXXX5250CJA
	Drückerlochteil links und rechts verwendbar mit Madenschraube intern <i>Handle only with grub screw hole in internal position</i>	Edelstahl - Stainless steel 304	949-708-500-055	1AJ18IPI06585SCJA
		Edelstahl Spiegelpol. - Polished Stainless Steel	-	1AJ18IPI065850CJA

	Bezeichnung - Description	Farbe - Finishes	Alte Art.-Nr. - Old code	1 Stück - Piece
	ZT - Drückerpaar mit 8mm VK <i>Pair Handles without roses with 8mm spindle</i>	Porz. Weiß/Ultra Messing - White Porc./PVD Gold 	949-718-000-118	1AJ18CMXXX5252CJA
		Porz. Schwarz/Ultra Messing - Black Porc./PVD Gold 	949-718-000-112	1AJ18CMXXX5253CJA
		Porz. Schwarz/Messing Pol. - Black Porc./Pol. Varnished	949-718-000-012	1AJ18CMXXX5256CJA
		Porz. Weiß/Messing Poliert - White porc./Pol. varnished	949-718-000-018	1AJ18CMXXX5261CJA
		Porz. Schwarz/Chrom - Black Porc./Pol. Chrome	949-718-000-002	1AJ18CMXXX52P4CJA
		Porz. Weiß/Chrom - White Porc./Pol. Chrome	949-718-000-008	1AJ18CMXXX52P6CJA
	Drückerlochteil rechts mit Madenschraube <i>Right handle only with grub screw hole in lower position</i>	Porz. Weiß/Ultra Messing - White Porc./PVD Gold 	949-718-400-118	1AJ18ID0065852CJA
		Porz. Schwarz/Ultra Messing - Black Porc./PVD Gold 	949-718-400-112	1AJ18ID0065853CJA
		Porz. Schwarz/Messing Pol. - Black Porc./Pol. Varnished	949-718-400-012	1AJ18ID0065856CJA
		Porz. Weiß/Messing Poliert - White porc./Pol. varnished	949-718-400-018	1AJ18ID0065861CJA
		Porz. Schwarz/Chrom - Black Porc./Pol. Chrome	949-718-400-002	1AJ18ID00658P4CJA
		Porz. Weiß/Chrom - White Porc./Pol. Chrome	949-718-400-008	1AJ18ID00658P6CJA
	Drückerlochteil links mit Madenschraube <i>Left handle only with grub screw hole in lower position</i>	Porz. Weiß/Ultra Messing - White Porc./PVD Gold 	949-718-300-118	1AJ18IS0065852CJA
		Porz. Schwarz/Ultra Messing - Black Porc./PVD Gold 	949-718-300-112	1AJ18IS0065853CJA
		Porz. Schwarz/Messing Pol. - Black Porc./Pol. Varnished	949-718-300-012	1AJ18IS0065856CJA
		Porz. Weiß/Messing Poliert - White porc./Pol. varnished	949-718-300-018	1AJ18IS0065861CJA
		Porz. Schwarz/Chrom - Black Porc./Pol. Chrome	949-718-300-002	1AJ18IS00658P4CJA
		Porz. Weiß/Chrom - White Porc./Pol. Chrome	949-718-300-008	1AJ18IS00658P6CJA
	Drückerlochteil links und rechts verwendbar mit Madenschraube intern <i>Handle only with grub screw hole in internal position</i>	Porz. Weiß/Ultra Messing - White Porc./PVD Gold 	949-708-500-118	1AJ18IPI065852CJA
		Porz. Schwarz/Ultra Messing - Black Porc./PVD Gold 	949-708-500-112	1AJ18IPI065853CJA
		Porz. Schwarz/Messing Pol. - Black Porc./Pol. Varnished	949-708-500-012	1AJ18IPI065856CJA
		Porz. Weiß/Messing Poliert - White porc./Pol. varnished	949-708-500-018	1AJ18IPI065861CJA
		Porz. Schwarz/Chrom - Black Porc./Pol. Chrome	949-708-500-002	1AJ18IPI0658P4CJA
		Porz. Weiß/Chrom - White Porc./Pol. Chrome	949-708-500-008	1AJ18IPI0658P6CJA





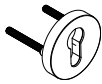

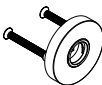





Schönbrunn











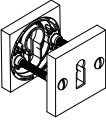

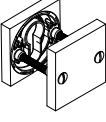

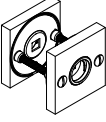
	Bezeichnung - Description	Farbe - Finishes	Alte Art.-Nr. - Old code	1 Stück - Piece
	ZT - Drückerpaar mit 8mm VK <i>Pair Handles without roses with 8mm spindle</i>	Chrom - Polished chrome	901-718-000-000	1AJ14CMXXX5205CJA
		Messing Rustik - Rustic brass	901-718-000-01M	1AJ14CMXXX521MCJA
		Ultra Messing - PVD Gold 	901-718-000-367	1AJ14CMXXX5246CJA
	Drückerlochteil rechts mit Madenschraube <i>Right handle only with grub screw hole in lower position</i>	Chrom - Polished chrome	901-718-400-000	1AJ14ID0065805CJA
		Messing Rustik - Rustic brass	901-718-400-01M	1AJ14ID006581MCJA
		Ultra Messing - PVD Gold 	901-718-400-367	1AJ14ID0065846CJA
	Drückerlochteil links mit Madenschraube <i>Left handle only with grub screw hole in lower position</i>	Chrom - Polished chrome	901-718-300-000	1AJ14IS0065805CJA
		Messing Rustik - Rustic brass	901-718-300-01M	1AJ14IS006581MCJA
		Ultra Messing - PVD Gold 	901-718-300-367	1AJ14IS0065846CJA

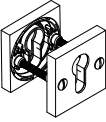

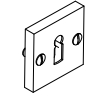

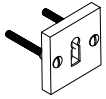

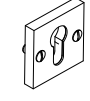

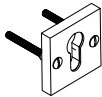

	Bezeichnung - Description	Farbe - Finishes	Alte Art.-Nr. - Old code	1 Stück - Piece
	Paar Rosetten mit Stütznocken + Schrauben M5x50 mit BB Lochung <i>Pair rosettes with support cams + screws M5x50 key hole</i>	Chrom - Polished chrome	373-154-400-000	1A000CDJ102B05XJA
		Schwarz RAL 9005 - Matt black RAL 9005	-	1A000CDJ102B18XJA
		Ultra Messing - PVD Gold	-	1A000CDJ102B46XJA
		Edelstahl - Stainless steel 304	373-154-400-055	1A000CDJ102B5SXJA
		Ultra Mattnickel - PVD Satin inox	373-154-400-066	1A000CDJ102B98XJA
Nickel spiegelpol. Plus - Pol. Nickel Plus	373-154-400-004	1A000CDJ102BK1XJA		
	Paar Rosetten mit Stütznocken + Schrauben M5x50 ohne Loch <i>Pair rosettes with support cams + screws M5x50 without key hole</i>	Chrom - Polished chrome	373-154-300-000	1A000CDJ102C05XJA
		Schwarz RAL 9005 - Matt black RAL 9005	-	1A000CDJ102C18XJA
		Ultra Messing - PVD Gold	-	1A000CDJ102C46XJA
		Edelstahl - Stainless steel 304	373-154-300-055	1A000CDJ102C5SXJA
		Ultra Mattnickel - PVD Satin inox	373-154-300-066	1A000CDJ102C98XJA
Nickel spiegelpol. Plus - Pol. Nickel Plus	373-154-300-004	1A000CDJ102CK1XJA		
	Paar Rosetten mit Stütznocken + Schrauben M5x50 mit Druckerlochung <i>Pair rosettes with support cams + screws M5x50 lever handle hole</i>	Chrom - Polished chrome	373-164-400-000	1A000CDJ102M05XJA
		Schwarz RAL 9005 - Matt black RAL 9005	373-164-400-180	1A000CDJ102M18XJA
		Ultra Messing - PVD Gold	-	1A000CDJ102M46XJA
		Edelstahl - Stainless steel 304	373-164-400-055	1A000CDJ102M5SXJA
		Ultra Mattnickel - PVD Satin inox	373-164-400-066	1A000CDJ102M98XJA
Nickel spiegelpol. Plus - Pol. Nickel Plus	373-164-400-004	1A000CDJ102MK1XJA		
	Paar Rosetten mit Stütznocken + Schrauben M5x50 mit PZ Lochung <i>Pair rosettes with support cams + screws M5x50 Euro profile hole</i>	Chrom - Polished chrome	373-154-500-000	1A000CDJ102Y05XJA
		Schwarz RAL 9005 - Matt black RAL 9005	-	1A000CDJ102Y18XJA
		Ultra Messing - PVD Gold	-	1A000CDJ102Y46XJA
		Edelstahl - Stainless steel 304	373-154-500-055	1A000CDJ102Y5SXJA
		Ultra Mattnickel - PVD Satin inox	373-154-500-066	1A000CDJ102Y98XJA
Nickel spiegelpol. Plus - Pol. Nickel Plus	373-154-500-004	1A000CDJ102YK1XJA		
	Schlüsselrosette blind Ø52x9 mm <i>Escutcheon without key hole Ø52x9 mm</i>	Chrom - Polished chrome	373-153-000-000	1AJ01BCXXXXX05XJA
		Schwarz RAL 9005 - Matt black RAL 9005	-	1AJ01BCXXXXX18XJA
		Ultra Messing - PVD Gold	-	1AJ01BCXXXXX46XJA
		Edelstahl - Stainless steel 304	373-153-000-055	1AJ01BCXXXXX5SXJA
		Ultra Mattnickel - PVD Satin inox	373-153-000-066	1AJ01BCXXXXX98XJA
Nickel spiegelpol. Plus - Pol. Nickel Plus	373-153-000-004	1AJ01BCXXXXXK1XJA		
	Schlüsselrosette blind Ø52x9 mm mit M5 Gewindenocken und Schrauben M5x50 <i>Escutcheon without key hole Ø52x9 mm with 2 threads + screws M5x50</i>	Chrom - Polished chrome	373-154-000-000	1AJ01BCXXX4505XJA
		Schwarz RAL 9005 - Matt black RAL 9005	-	1AJ01BCXXX4518XJA
		Ultra Messing - PVD Gold	373-154-000-367	1AJ01BCXXX4546XJA
		Edelstahl - Stainless steel 304	373-154-000-055	1AJ01BCXXX455SXJA
		Ultra Mattnickel - PVD Satin inox	373-154-000-066	1AJ01BCXXX4598XJA
Nickel spiegelpol. Plus - Pol. Nickel Plus	373-154-000-004	1AJ01BCXXX45K1XJA		
	Schlüsselrosette BB Ø52x9 mm <i>Key escutcheon Ø52x9 mm</i>	Chrom - Polished chrome	373-153-100-000	1AJ01BNXXXXX05XJA
		Schwarz RAL 9005 - Matt black RAL 9005	-	1AJ01BNXXXXX18XJA
		Ultra Messing - PVD Gold	-	1AJ01BNXXXXX46XJA
		Edelstahl - Stainless steel 304	373-153-100-055	1AJ01BNXXXXX5SXJA
		Ultra Mattnickel - PVD Satin inox	373-153-100-066	1AJ01BNXXXXX98XJA
Nickel spiegelpol. Plus - Pol. Nickel Plus	373-153-100-004	1AJ01BNXXXXXK1XJA		
	Schlüsselrosette BB Ø52x9 mm mit M5 Gewindenocken und Schrauben M5x50 <i>Key escutcheon Ø52x9 mm with M5 threads and screws M5x50</i>	Chrom - Polished chrome	373-154-100-000	1AJ01BNXXX4505XJA
		Schwarz RAL 9005 - Matt black RAL 9005	-	1AJ01BNXXX4518XJA
		Ultra Messing - PVD Gold	-	1AJ01BNXXX4546XJA
		Edelstahl - Stainless steel 304	373-154-100-055	1AJ01BNXXX455SXJA
		Ultra Mattnickel - PVD Satin inox	373-154-100-066	1AJ01BNXXX4598XJA
Nickel spiegelpol. Plus - Pol. Nickel Plus	373-154-100-004	1AJ01BNXXX45K1XJA		
	Schlüsselrosette PZ Ø52x9 mm <i>Euro profile escutcheon Ø52x9 mm</i>	Chrom - Polished chrome	373-153-200-000	1AJ01BYXXXXX05XJA
		Schwarz RAL 9005 - Matt black RAL 9005	373-153-200-180	1AJ01BYXXXXX18XJA
		Ultra Messing - PVD Gold	-	1AJ01BYXXXXX46XJA
		Edelstahl - Stainless steel 304	373-153-200-055	1AJ01BYXXXXX5SXJA
		Ultra Mattnickel - PVD Satin inox	373-153-200-066	1AJ01BYXXXXX98XJA
Nickel spiegelpol. Plus - Pol. Nickel Plus	373-153-200-004	1AJ01BYXXXXXK1XJA		

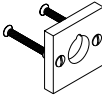





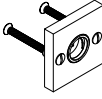

	Bezeichnung - Description	Farbe - Finishes	Alte Art.-Nr. - Old code	1 Stück - Piece
 <p>Schlüsselrosette PZ Ø52x9 mm mit M5 Gewindenocken und Schrauben M5x50 <i>Euro profile escutcheon Ø52x9 mm with M5 threads and screws M5x50</i></p>	Chrom - Polished chrome	373-154-200-000	1AJ01BYXXX4505XJA	
	Schwarz RAL 9005 - Matt black RAL 9005	-	1AJ01BYXXX4518XJA	
	Ultra Messing - PVD Gold	-	1AJ01BYXXX4546XJA	
	Edelstahl - Stainless steel 304	373-154-200-055	1AJ01BYXXX4555XJA	
	Ultra Mattnickel - PVD Satin inox	373-154-200-066	1AJ01BYXXX4598XJA	
	Nickel spiegelpol. Plus - Pol. Nickel Plus	373-154-200-004	1AJ01BYXXX45K1XJA	
 <p>Rosette Ø52x9 mm für Knöpfe mit M5 Gewindenocken und Schrauben M5x50 <i>Rose Ø52x9 mm for knobs with M5 threads and screws M5x50</i></p>	Chrom - Polished chrome	373-064-000-000	1AJ01R00FP4505XJA	
	Schwarz RAL 9005 - Matt black RAL 9005	373-064-000-180	1AJ01R00FP4518XJA	
	Ultra Messing - PVD Gold	373-064-000-367	1AJ01R00FP4546XJA	
	Edelstahl - Stainless steel 304	373-064-000-055	1AJ01R00FP4555XJA	
	Ultra Mattnickel - PVD Satin inox	373-064-000-066	1AJ01R00FP4598XJA	
	Nickel spiegelpol. Plus - Pol. Nickel Plus	373-064-000-004	1AJ01R00FP45K1XJA	
 <p>Rosette Ø52x9 mm <i>Rose Ø52x9 mm</i></p>	Chrom - Polished chrome	373-163-000-000	1AJ01R0XXXX05XJA	
	Ultra Messing - PVD Gold	373-164-000-367	1AJ01R0XXXX46XJA	
	Schwarz RAL 9005 - Matt black RAL 9005	373-163-000-180	1AJ01R0XXXX18XXA	
	Edelstahl - Stainless steel 304	373-163-000-055	1AJ01R0XXXX55XJA	
	Ultra Mattnickel - PVD Satin inox	373-163-000-066	1AJ01R0XXXX98XJA	
	Nickel spiegelpol. Plus - Pol. Nickel Plus	373-163-000-004	1AJ01R0XXXXK1XJA	
 <p>Rosette Ø52x9 mm mit M5 Gewindenocken und Schrauben M5x50 <i>Rose Ø52x9 mm with M5 threads and screws M5x50</i></p>	Chrom - Polished chrome	373-164-000-000	1AJ01R0XXX4505XJA	
	Schwarz RAL 9005 - Matt black RAL 9005	-	1AJ01R0XXX4518XJA	
	Ultra Messing - PVD Gold	373-164-000-367	1AJ01R0XXX4546XJA	
	Edelstahl - Stainless steel 304	373-164-000-055	1AJ01R0XXX4555XJA	
	Ultra Mattnickel - PVD Satin inox	373-164-000-066	1AJ01R0XXX4598XJA	
	Nickel spiegelpol. Plus - Pol. Nickel Plus	373-164-000-004	1AJ01R0XXX45K1XJA	

	Bezeichnung - Description	Farbe - Finishes	Alte Art.-Nr. - Old code	1 Stück - Piece
	Paar Rosetten mit Stütznocken + Schrauben M5x50 mit BB Lochung <i>Pair rosettes with support cams + screws M5x50 key hole</i>	Chrom - Polished chrome	993-154-400-000	1A000CDJ032B05XJA
		Ultra Messing - PVD Gold	993-154-400-367	1A000CDJ032B46XJA
		Edelstahl Spiegelpol. - Polished Stainless Steel	993-154-400-155	1A000CDJ032B50XJA
		Edelstahl - Stainless steel 304	993-154-400-055	1A000CDJ032B55XJA
		Antik Nickel - Antique Nickel	993-154-400-444	1A000CDJ032B8BXJA
		Ultra Mattnickel - PVD Satin inox	993-154-400-066	1A000CDJ032B98XJA
	Paar Rosetten mit Stütznocken + Schrauben M5x50 ohne Loch <i>Pair rosettes with support cams + screws M5x50 without key hole</i>	Chrom - Polished chrome	993-154-300-000	1A000CDJ032C05AJA
		Ultra Messing - PVD Gold	993-154-300-367	1A000CDJ032C46AJA
		Edelstahl Spiegelpol. - Polished Stainless Steel	993-154-300-155	1A000CDJ032C50AJA
		Edelstahl - Stainless steel 304	993-154-300-055	1A000CDJ032C55AJA
		Antik Nickel - Antique Nickel	993-154-300-444	1A000CDJ032C8BAJA
		Ultra Mattnickel - PVD Satin inox	993-154-300-066	1A000CDJ032C98AJA
	Paar Rosetten mit Stütznocken + Schrauben M5x50 mit Druckerlochung <i>Pair rosettes with support cams + screws M5x50 lever handle hole</i>	Chrom - Polished chrome	993-164-400-000	1A000CDJ032M05XJA
		Ultra Messing - PVD Gold	993-164-400-367	1A000CDJ032M46XJA
		Edelstahl Spiegelpol. - Polished Stainless Steel	993-164-400-155	1A000CDJ032M50XJA
		Edelstahl - Stainless steel 304	993-164-400-055	1A000CDJ032M55XJA
		Antik Nickel - Antique Nickel	993-164-400-444	1A000CDJ032M8BXJA
		Ultra Mattnickel - PVD Satin inox	993-164-400-066	1A000CDJ032M98XJA
	Paar Rosetten mit Stütznocken + Schrauben M5x50 mit PZ Lochung <i>Pair rosettes with support cams + screws M5x50 Euro profile hole</i>	Chrom - Polished chrome	993-154-500-000	1A000CDJ032Y05XJA
		Ultra Messing - PVD Gold	993-154-500-367	1A000CDJ032Y46AJA
		Edelstahl Spiegelpol. - Polished Stainless Steel	993-154-500-155	1A000CDJ032Y50XJA
		Edelstahl - Stainless steel 304	993-154-500-055	1A000CDJ032Y55XJA
		Antik Nickel - Antique Nickel	993-154-500-444	1A000CDJ032Y8BXJA
		Ultra Mattnickel - PVD Satin inox	993-154-500-066	1A000CDJ032Y98XJA
	Schlüsselrosette blind Ø55x9 mm <i>Escutcheon without key hole Ø55x9 mm</i>	Chrom - Polished chrome	993-153-000-000	1AJ03BCXXXXX05XJA
		Ultra Messing - PVD Gold	993-153-000-367	1AJ03BCXXXXX46XJA
		Edelstahl Spiegelpol. - Polished Stainless Steel	-	1AJ03BCXXXXX50XJA
		Edelstahl - Stainless steel 304	993-153-000-055	1AJ03BCXXXXX55XJA
		Antik Nickel - Antique Nickel	993-153-000-444	1AJ03BCXXXXX8BXJA
		Ultra Mattnickel - PVD Satin inox	993-153-000-066	1AJ03BCXXXXX98XJA
	Schlüsselrosette blind Ø55x9 mm mit M5 Gewindenocken und Schrauben M5x50 <i>Escutcheon without key hole Ø55x9 mm with 2 threads + screws M5x50</i>	Chrom - Polished chrome	993-154-000-000	1AJ03BCXXX4505XJA
		Ultra Messing - PVD Gold	993-154-000-367	1AJ03BCXXX4546XJA
		Edelstahl Spiegelpol. - Polished Stainless Steel	-	1AJ03BCXXX4550XJA
		Edelstahl - Stainless steel 304	993-154-000-055	1AJ03BCXXX4555XJA
		Antik Nickel - Antique Nickel	993-154-000-444	1AJ03BCXXX458BXJA
		Ultra Mattnickel - PVD Satin inox	993-154-000-066	1AJ03BCXXX4598XJA
	Schlüsselrosette BB Ø55x9 mm <i>Key escutcheon Ø55x9 mm</i>	Chrom - Polished chrome	993-153-100-000	1AJ03BNXXXXX05XJA
		Ultra Messing - PVD Gold	993-153-100-367	1AJ03BNXXXXX46XJA
		Edelstahl Spiegelpol. - Polished Stainless Steel	993-153-100-155	1AJ03BNXXXXX50XJA
		Edelstahl - Stainless steel 304	993-153-100-055	1AJ03BNXXXXX55XJA
		Antik Nickel - Antique Nickel	993-153-100-444	1AJ03BNXXXXX8BXJA
		Ultra Mattnickel - PVD Satin inox	993-153-100-066	1AJ03BNXXXXX98XJA
	Schlüsselrosette BB Ø55x9 mm mit M5 Gewindenocken und Schrauben M5x50 <i>Key escutcheon Ø55x9 mm with M5 threads and screws M5x50</i>	Chrom - Polished chrome	993-154-100-000	1AJ03BNXXX4505XJA
		Ultra Messing - PVD Gold	993-154-100-367	1AJ03BNXXX4546XJA
		Edelstahl Spiegelpol. - Polished Stainless Steel	993-154-100-155	1AJ03BNXXX4550XJA
		Edelstahl - Stainless steel 304	993-154-100-055	1AJ03BNXXX4555XJA
		Antik Nickel - Antique Nickel	993-154-100-444	1AJ03BNXXX458BXJA
		Ultra Mattnickel - PVD Satin inox	993-154-100-066	1AJ03BNXXX4598XJA
	Schlüsselrosette PZ Ø55x9 mm <i>Euro profile escutcheon Ø55x9 mm</i>	Chrom - Polished chrome	993-153-200-000	1AJ03BYXXXXX05XJA
		Ultra Messing - PVD Gold	993-153-200-367	1AJ03BYXXXXX46XJA
		Edelstahl Spiegelpol. - Polished Stainless Steel	993-153-200-155	1AJ03BYXXXXX50XJA
		Edelstahl - Stainless steel 304	993-153-200-055	1AJ03BYXXXXX55XJA
		Antik Nickel - Antique Nickel	993-153-200-444	1AJ03BYXXXXX8BXJA
		Ultra Mattnickel - PVD Satin inox	993-153-200-066	1AJ03BYXXXXX98XJA

	Bezeichnung - Description	Farbe - Finishes	Alte Art.-Nr. - Old code	1 Stück - Piece
	Schlüsselrosette PZ Ø55x9 mm mit M5 Gewindenocken und Schrauben M5x50 <i>Euro profile escutcheon Ø55x9 mm with M5 threads and screws M5x50</i>	Chrom - Polished chrome	993-154-200-000	1AJ03BYXXX4505XJA
		Ultra Messing - PVD Gold 	993-154-200-367	1AJ03BYXXX4546XJA
		Edelstahl Spiegelpol. - Polished Stainless Steel	993-154-200-155	1AJ03BYXXX4550XJA
		Edelstahl - Stainless steel 304	993-154-200-055	1AJ03BYXXX4555XJA
		Antik Nickel - Antique Nickel	993-154-200-444	1AJ03BYXXX458BXJA
	Ultra Mattnickel - PVD Satin inox 	993-154-200-066	1AJ03BYXXX4598XJA	
	Rosette Ø55x9 mm für Knöpfe mit M5 Gewindenocken und Schrauben M5x50 <i>Rose Ø55x9 mm for knobs with M5 threads and screws M5x50</i>	Chrom - Polished chrome	993-164-100-000	1AJ03R00FP4505XJA
		Ultra Messing - PVD Gold 	993-164-100-367	1AJ03R00FP4546XJA
		Antik Nickel - Antique Nickel	993-164-100-444	1AJ03R00FP458BXJA
		Ultra Mattnickel - PVD Satin inox 	993-164-100-066	1AJ03R00FP4598XJA
	Rosette Ø55x9 mm <i>Rose Ø55x9 mm</i>	Chrom - Polished chrome	993-163-000-000	1AJ03R0XXXXX05XJA
		Ultra Messing - PVD Gold 	993-163-000-367	1AJ03R0XXXXX46XJA
		Edelstahl Spiegelpol. - Polished Stainless Steel	993-163-000-155	1AJ03R0XXXXX50XJA
		Edelstahl - Stainless steel 304	993-163-000-055	1AJ03R0XXXXX55XJA
		Antik Nickel - Antique Nickel	993-163-000-444	1AJ03R0XXXXX8BXJA
	Ultra Mattnickel - PVD Satin inox 	993-163-000-066	1AJ03R0XXXXX98XJA	
	Rosette Ø55x9 mm mit M5 Gewindenocken und Schrauben M5x50 <i>Rose Ø55x9 mm with M5 threads and screws M5x50</i>	Chrom - Polished chrome	993-164-000-000	1AJ03R0XXX4505XJA
		Ultra Messing - PVD Gold 	993-164-000-367	1AJ03R0XXX4546XJA
		Edelstahl Spiegelpol. - Polished Stainless Steel	993-164-000-155	1AJ03R0XXX4550XJA
		Edelstahl - Stainless steel 304	993-164-000-055	1AJ03R0XXX4555XJA
		Antik Nickel - Antique Nickel	993-164-000-444	1AJ03R0XXX458BXJA
	Ultra Mattnickel - PVD Satin inox 	993-164-000-066	1AJ03R0XXX4598XJA	











	Bezeichnung - Description	Farbe - Finishes	Alte Art.-Nr. - Old code	1 Stück - Piece
	<p>Paar Rosetten mit Stütznocken + Schrauben M5x50 mit BB Lochung</p> <p>Pair rosettes with support cams + screws M5x50 key hole</p>	<p>Chrom - Polished chrome</p> <p>Ultra Messing - PVD Gold </p> <p>Ultra Mattnickel - PVD Satin inox</p> <p>Nickel spiegelpol. Plus - Pol. Nickel Plus </p>	<p>963-154-400-000</p> <p>963-154-400-367</p> <p>963-154-400-066</p> <p>963-154-400-004</p>	<p>1A000CDJ042B05XJA</p> <p>1A000CDJ042B46XJA</p> <p>1A000CDJ042B98XJA</p> <p>1A000CDJ042BK1XJA</p>
	<p>Paar Rosetten mit Stütznocken + Schrauben M5x50 ohne Loch</p> <p>Pair rosettes with support cams + screws M5x50 without key hole</p>	<p>Chrom - Polished chrome</p> <p>Ultra Messing - PVD Gold </p> <p>Ultra Mattnickel - PVD Satin inox</p> <p>Nickel spiegelpol. Plus - Pol. Nickel Plus </p>	<p>963-154-300-000</p> <p>963-154-300-367</p> <p>963-154-300-066</p> <p>963-154-300-004</p>	<p>1A000CDJ042C05XJA</p> <p>1A000CDJ042C46XJA</p> <p>1A000CDJ042C98XJA</p> <p>1A000CDJ042CK1XJA</p>
	<p>Paar Rosetten mit Stütznocken + Schrauben M5x50 mit Drückerlochung</p> <p>Pair rosettes with support cams + screws M5x50 lever handle hole</p>	<p>Chrom - Polished chrome</p> <p>Ultra Messing - PVD Gold </p> <p>Ultra Mattnickel - PVD Satin inox</p> <p>Nickel spiegelpol. Plus - Pol. Nickel Plus </p>	<p>963-164-400-000</p> <p>963-164-400-367</p> <p>963-164-400-066</p> <p>963-164-400-004</p>	<p>1A000CDJ042M05XJA</p> <p>1A000CDJ042M46XJA</p> <p>1A000CDJ042M98XJA</p> <p>1A000CDJ042MK1XJA</p>
	<p>Paar Rosetten mit Stütznocken + Schrauben M5x50 mit PZ Lochung</p> <p>Pair rosettes with support cams + screws M5x50 Euro profile hole</p>	<p>Chrom - Polished chrome</p> <p>Ultra Messing - PVD Gold </p> <p>Ultra Mattnickel - PVD Satin inox</p> <p>Nickel spiegelpol. Plus - Pol. Nickel Plus </p>	<p>963-154-500-000</p> <p>963-154-500-367</p> <p>963-154-500-066</p> <p>963-154-500-004</p>	<p>1A000CDJ042Y05XJA</p> <p>1A000CDJ042Y46XJA</p> <p>1A000CDJ042Y98XJA</p> <p>1A000CDJ042YK1XJA</p>
	<p>Schlüsselrosette blind 52x52x9 mm</p> <p>Escutcheon without key hole 52x52x9 mm</p>	<p>Chrom - Polished chrome</p> <p>Ultra Messing - PVD Gold </p> <p>Ultra Mattnickel - PVD Satin inox</p> <p>Nickel spiegelpol. Plus - Pol. Nickel Plus </p>	<p>963-153-000-000</p> <p>963-153-000-367</p> <p>963-153-000-066</p> <p>963-153-000-004</p>	<p>1AJ04BCXXXXX05XJA</p> <p>1AJ04BCXXXXX46XJA</p> <p>1AJ04BCXXXXX98XJA</p> <p>1AJ04BCXXXXXK1XJA</p>
	<p>Schlüsselrosette blind 52x52x9 mm mit M5 Gewindenocken und Schrauben M5x50</p> <p>Escutcheon without key hole 52x52x9 mm with 2 threads + screws M5x50</p>	<p>Chrom - Polished chrome</p> <p>Ultra Messing - PVD Gold </p> <p>Ultra Mattnickel - PVD Satin inox</p> <p>Nickel spiegelpol. Plus - Pol. Nickel Plus </p>	<p>963-154-000-000</p> <p>963-154-000-367</p> <p>963-154-000-066</p> <p>963-154-000-004</p>	<p>1AJ04BCXXX4505XJA</p> <p>1AJ04BCXXX4546XJA</p> <p>1AJ04BCXXX4598XJA</p> <p>1AJ04BCXXX45K1XJA</p>
	<p>Schlüsselrosette BB 52x52x9 mm</p> <p>Key escutcheon 52x52x9 mm</p>	<p>Chrom - Polished chrome</p> <p>Ultra Messing - PVD Gold </p> <p>Ultra Mattnickel - PVD Satin inox</p> <p>Nickel spiegelpol. Plus - Pol. Nickel Plus </p>	<p>963-153-100-000</p> <p>963-153-100-367</p> <p>963-153-100-066</p> <p>963-153-100-004</p>	<p>1AJ04BNXXXXX05XJA</p> <p>1AJ04BNXXXXX46XJA</p> <p>1AJ04BNXXXXX98XJA</p> <p>1AJ04BNXXXXXK1XJA</p>
	<p>Schlüsselrosette BB 52x52x9 mm mit M5 Gewindenocken und Schrauben M5x50</p> <p>Key escutcheon 52x52x9 mm with M5 threads and screws M5x50</p>	<p>Chrom - Polished chrome</p> <p>Ultra Messing - PVD Gold </p> <p>Ultra Mattnickel - PVD Satin inox</p> <p>Nickel spiegelpol. Plus - Pol. Nickel Plus </p>	<p>963-154-100-000</p> <p>963-154-100-367</p> <p>963-154-100-066</p> <p>963-154-100-004</p>	<p>1AJ04BNXXX4505XJA</p> <p>1AJ04BNXXX4546XJA</p> <p>1AJ04BNXXX4598XJA</p> <p>1AJ04BNXXX45K1XJA</p>
	<p>Schlüsselrosette PZ 52x52x9 mm</p> <p>Euro profile escutcheon 52x52x9 mm</p>	<p>Chrom - Polished chrome</p> <p>Ultra Messing - PVD Gold </p> <p>Ultra Mattnickel - PVD Satin inox</p> <p>Nickel spiegelpol. Plus - Pol. Nickel Plus </p>	<p>963-153-200-000</p> <p>963-153-200-367</p> <p>963-153-200-066</p> <p>963-153-200-004</p>	<p>1AJ04BYXXXXX05XJA</p> <p>1AJ04BYXXXXX46XJA</p> <p>1AJ04BYXXXXX98XJA</p> <p>1AJ04BYXXXXXK1XJA</p>

	Bezeichnung - Description	Farbe - Finishes	Alte Art.-Nr. - Old code	1 Stück - Piece
	Schlüsselrosette PZ 52x52x9 mm mit M5 Gewindenocken und Schrauben M5x50 <i>Euro profile escutcheon 52x52x9 mm with M5 threads and screws M5x50</i>	Chrom - Polished chrome	963-154-200-000	1AJ04BYXXX4505XJA
		Ultra Messing - PVD Gold 	963-154-200-367	1AJ04BYXXX4546XJA
		Ultra Mattnickel - PVD Satin inox	963-154-200-066	1AJ04BYXXX4598XJA
		Nickel spiegelpol. Plus - Pol. Nickel Plus 	963-154-200-004	1AJ04BYXXX45K1XJA
	Rosette 52x52x9 mm für Knöpfe mit M5 Gewindenocken und Schrauben M5x50 <i>Rose 52x52x9 mm for knobs with M5 threads and screws M5x50</i>	Chrom - Polished chrome	963-164-100-000	1AJ04R00FP4505XJA
		Ultra Messing - PVD Gold 	963-164-100-367	1AJ04R00FP4546XJA
		Ultra Mattnickel - PVD Satin inox	963-164-100-066	1AJ04R00FP4598XJA
		Nickel spiegelpol. Plus - Pol. Nickel Plus 	963-164-100-004	1AJ04R00FP45K1XJA
	Rosette 52x52x9 mm <i>Rose 52x52x9 mm</i>	Chrom - Polished chrome	963-163-000-000	1AJ04R0XXXXX05XJA
		Ultra Messing - PVD Gold 	963-163-000-367	1AJ04R0XXXXX46XJA
		Ultra Mattnickel - PVD Satin inox	963-163-000-066	1AJ04R0XXXXX98XJA
		Nickel spiegelpol. Plus - Pol. Nickel Plus 	963-163-000-004	1AJ04R0XXXXXK1XJA
	Rosette 52x52x9 mm mit M5 Gewindenocken und Schrauben M5x50 <i>Rose 52x52x9 mm with M5 threads and screws M5x50</i>	Chrom - Polished chrome	963-164-000-000	1AJ04R0XXX4505XJA
		Ultra Messing - PVD Gold 	963-164-000-367	1AJ04R0XXX4546XJA
		Ultra Mattnickel - PVD Satin inox	963-164-000-066	1AJ04R0XXX4598XJA
		Nickel spiegelpol. Plus - Pol. Nickel Plus 	963-164-000-004	1AJ04R0XXX45K1XJA

	Bezeichnung - Description	Farbe - Finishes	Alte Art.-Nr. - Old code	1 Stück - Piece
	Paar Rosetten mit Stütznocken + Schrauben M5x50 mit BB Lochung <i>Pair rosettes with support cams + screws M5x50 key hole</i>	Chrom - Polished chrome	984-154-400-000	1A000CD13J2B05XJA
		Ultra Messing - PVD Gold	984-154-400-367	1A000CD13J2B46XJA
		Antik Nickel - Antique Nickel	984-154-400-444	1A000CD13J2B8BXJA
	Paar Rosetten mit Stütznocken + Schrauben M5x50 mit Drückerlochung <i>Pair rosettes with support cams + screws M5x50 lever handle hole</i>	Chrom - Polished chrome	984-164-400-000	1A000CD13J2M05XJA
		Ultra Messing - PVD Gold	984-164-400-367	1A000CD13J2M46XJA
		Antik Nickel - Antique Nickel	984-164-400-444	1A000CD13J2M8BXJA
	Paar Rosetten mit Stütznocken + Schrauben M5x50 mit PZ Lochung <i>Pair rosettes with support cams + screws M5x50 Euro profile hole</i>	Chrom - Polished chrome	984-154-500-000	1A000CD13J2Y05XJA
		Ultra Messing - PVD Gold	984-154-500-367	1A000CD13J2Y46XJA
		Antik Nickel - Antique Nickel	984-154-500-444	1A000CD13J2Y8BXJA
	Schlüsselrosette BB Ø55x10 mm <i>Key escutcheon Ø55x10 mm</i>	Chrom - Polished chrome	984-153-100-000	1AJ13BNXXXXX05XJA
		Ultra Messing - PVD Gold	984-153-100-367	1AJ13BNXXXXX46XJA
		Antik Nickel - Antique Nickel	984-153-100-444	1AJ13BNXXXXX8BXJA
	Schlüsselrosette BB Ø55x10 mm mit M5 Gewindenocken und Schrauben M5x50 <i>Key escutcheon Ø55x10 mm with M5 threads and screws M5x50</i>	Chrom - Polished chrome	984-154-100-000	1AJ13BNXXX4505XJA
		Ultra Messing - PVD Gold	984-154-100-367	1AJ13BNXXX4546XJA
		Antik Nickel - Antique Nickel	984-154-100-444	1AJ13BNXXX458BXJA
	Schlüsselrosette PZ Ø55x10 mm <i>Euro profile escutcheon Ø55x10 mm</i>	Chrom - Polished chrome	984-153-200-000	1AJ13BYXXXXX05XJA
		Ultra Messing - PVD Gold	984-153-200-367	1AJ13BYXXXXX46XJA
		Antik Nickel - Antique Nickel	984-153-200-444	1AJ13BYXXXXX8BXJA
	Schlüsselrosette PZ Ø55x10 mm mit M5 Gewindenocken und Schrauben M5x50 <i>Euro profile escutcheon Ø55x10 mm with M5 threads and screws M5x50</i>	Chrom - Polished chrome	984-154-200-000	1AJ13BYXXX4505XJA
		Ultra Messing - PVD Gold	984-154-200-367	1AJ13BYXXX4546XJA
		Antik Nickel - Antique Nickel	984-154-200-444	1AJ13BYXXX458BXJA
	Rosette Ø55x10 mm <i>Rose Ø55x10 mm</i>	Chrom - Polished chrome	984-163-000-000	1AJ13R0XXXXX05XJA
		Ultra Messing - PVD Gold	984-163-000-367	1AJ13R0XXXXX46XJA
		Antik Nickel - Antique Nickel	984-163-000-444	1AJ13R0XXXXX8BXJA
	Rosette Ø55x10 mm mit M5 Gewindenocken und Schrauben M5x50 <i>Rose Ø55x10 mm with M5 threads and screws M5x50</i>	Chrom - Polished chrome	984-164-000-000	1AJ13R0XXX4505XJA
		Ultra Messing - PVD Gold	984-164-000-367	1AJ13R0XXX4546XJA
		Antik Nickel - Antique Nickel	984-164-000-444	1AJ13R0XXX458BXJA

	Bezeichnung - Description	Farbe - Finishes	Alte Art.-Nr. - Old code	1 Stück - Piece
	Paar Rosetten mit Stütznocken + Schrauben M5x50 mit BB Lochung <i>Pair rosettes with support cams + screws M5x50 key hole</i>	Chrom - Polished chrome	992-154-400-000	1A000CDJ182B05XJA
		Schwarz RAL 9005 - Matt black RAL 9005	992-154-400-180	1A000CDJ182B18XJA
		Ultra Messing - PVD Gold	992-154-400-367	1A000CDJ182B46XJA
		Nickel spiegelpol. Plus - Pol. Nickel Plus	992-154-400-004	1A000CDJ182BK1XJA
	Paar Rosetten mit Stütznocken + Schrauben M5x50 ohne Loch <i>Pair rosettes with support cams + screws M5x50 without key hole</i>	Chrom - Polished chrome	992-154-300-000	1A000CDJ182C05XJA
		Schwarz RAL 9005 - Matt black RAL 9005	992-154-300-180	1A000CDJ182C18XJA
		Ultra Messing - PVD Gold	992-154-300-367	1A000CDJ182C46XJA
		Nickel spiegelpol. Plus - Pol. Nickel Plus	992-154-300-004	1A000CDJ182CK1XJA
	Paar Rosetten mit Stütznocken + Schrauben M5x50 mit Druckerlochung <i>Pair rosettes with support cams + screws M5x50 lever handle hole</i>	Chrom - Polished chrome	992-164-400-000	1A000CDJ182M05XJA
		Schwarz RAL 9005 - Matt black RAL 9005	992-164-400-180	1A000CDJ182M18XJA
		Ultra Messing - PVD Gold	992-164-400-367	1A000CDJ182M46XJA
		Nickel spiegelpol. Plus - Pol. Nickel Plus	992-164-400-004	1A000CDJ182MK1XJA
	Paar Rosetten mit Stütznocken + Schrauben M5x50 mit PZ Lochung <i>Pair rosettes with support cams + screws M5x50 Euro profile hole</i>	Chrom - Polished chrome	992-154-500-000	1A000CDJ182Y05XJA
		Schwarz RAL 9005 - Matt black RAL 9005	992-154-500-180	1A000CDJ182Y18XJA
		Ultra Messing - PVD Gold	992-154-500-367	1A000CDJ182Y46XJA
		Nickel spiegelpol. Plus - Pol. Nickel Plus	992-154-500-004	1A000CDJ182YK1XJA
	Schlüsselrosette blind Ø54x10 mm <i>Escutcheon without key hole Ø54x10 mm</i>	Chrom - Polished chrome	992-153-000-000	1AJ18BCXXXXX05XJA
		Schwarz RAL 9005 - Matt black RAL 9005	992-153-000-180	1AJ18BCXXXXX18XJA
		Ultra Messing - PVD Gold	992-153-000-367	1AJ18BCXXXXX46XJA
		Nickel spiegelpol. Plus - Pol. Nickel Plus	992-153-000-004	1AJ18BCXXXXXK1XJA
	Schlüsselrosette blind Ø54x10 mm mit M5 Gewindenocken und Schrauben M5x50 <i>Escutcheon without key hole Ø54x10 mm with 2 threads + screws M5x50</i>	Chrom - Polished chrome	992-154-000-000	1AJ18BCXXX4505XJA
		Schwarz RAL 9005 - Matt black RAL 9005	992-154-000-180	1AJ18BCXXX4518XJA
		Ultra Messing - PVD Gold	992-154-000-367	1AJ18BCXXX4546XJA
		Nickel spiegelpol. Plus - Pol. Nickel Plus	992-154-000-004	1AJ18BCXXX45K1XJA
	Schlüsselrosette BB Ø54x10 mm <i>Key escutcheon Ø54x10 mm</i>	Chrom - Polished chrome	992-153-100-000	1AJ18BNXXXXX05XJA
		Schwarz RAL 9005 - Matt black RAL 9005	992-153-100-180	1AJ18BNXXXXX18XJA
		Ultra Messing - PVD Gold	992-153-100-367	1AJ18BNXXXXX46XJA
		Nickel spiegelpol. Plus - Pol. Nickel Plus	992-153-100-004	1AJ18BNXXXXXK1XJA
	Schlüsselrosette BB Ø54x10 mm mit M5 Gewindenocken und Schrauben M5x50 <i>Key escutcheon Ø54x10 mm with M5 threads and screws M5x50</i>	Chrom - Polished chrome	992-154-100-000	1AJ18BNXXX4505XJA
		Schwarz RAL 9005 - Matt black RAL 9005	992-154-100-180	1AJ18BNXXX4518XJA
		Ultra Messing - PVD Gold	992-154-100-367	1AJ18BNXXX4546XJA
		Nickel spiegelpol. Plus - Pol. Nickel Plus	992-154-100-004	1AJ18BNXXX45K1XJA
	Schlüsselrosette PZ Ø54x10 mm <i>Euro profile escutcheon Ø54x10 mm</i>	Chrom - Polished chrome	992-153-200-000	1AJ18BYXXXXX05XJA
		Schwarz RAL 9005 - Matt black RAL 9005	992-153-200-180	1AJ18BYXXXXX18XJA
		Ultra Messing - PVD Gold	992-153-200-367	1AJ18BYXXXXX46XJA
		Nickel spiegelpol. Plus - Pol. Nickel Plus	992-153-200-004	1AJ18BYXXXXXK1XJA

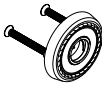





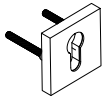
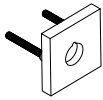
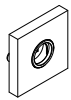
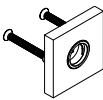



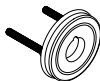

	Bezeichnung - Description	Farbe - Finishes	Alte Art.-Nr. - Old code	1 Stück - Piece
	Schlüsselrosette PZ Ø54x10 mm mit M5 Gewindenocken und Schrauben M5x50 <i>Euro profile escutcheon Ø54x10 mm with M5 threads and screws M5x50</i>	Chrom - Polished chrome	992-154-200-000	1AJ18BYXXX4505XJA
		Schwarz RAL 9005 - Matt black RAL 9005	992-154-200-180	1AJ18BYXXX4518XJA
		Ultra Messing - PVD Gold 	992-154-200-367	1AJ18BYXXX4546XJA
		Nickel spiegelpol. Plus - Pol. Nickel Plus 	992-154-200-004	1AJ18BYXXX45K1XJA
	Rosette Ø54x10 mm für Knöpfe mit M5 Gewindenocken und Schrauben M5x50 <i>Rose Ø54x10 mm for knobs with M5 threads and screws M5x50</i>	Chrom - Polished chrome	992-164-100-000	1AJ18R00FP4505XJA
		Schwarz RAL 9005 - Matt black RAL 9005	992-164-100-180	1AJ18R00FP4518XJA
		Ultra Messing - PVD Gold 	992-164-100-367	1AJ18R00FP4546XJA
		Nickel spiegelpol. Plus - Pol. Nickel Plus 	992-164-100-004	1AJ18R00FP45K1XJA
	Rosette Ø54x10 mm <i>Rose Ø54x10 mm</i>	Chrom - Polished chrome	992-163-000-000	1AJ18R0XXXX05XJA
		Schwarz RAL 9005 - Matt black RAL 9005	992-163-000-180	1AJ18R0XXXX18XJA
		Ultra Messing - PVD Gold 	992-163-000-367	1AJ18R0XXXX46XJA
		Nickel spiegelpol. Plus - Pol. Nickel Plus 	992-163-000-004	1AJ18R0XXXXK1XJA
	Rosette Ø54x10 mm mit M5 Gewindenocken und Schrauben M5x50 <i>Rose Ø54x10 mm with M5 threads and screws M5x50</i>	Chrom - Polished chrome	992-164-000-000	1AJ18R0XXX4505XJA
		Schwarz RAL 9005 - Matt black RAL 9005	992-164-000-180	1AJ18R0XXX4518XJA
		Ultra Messing - PVD Gold 	992-164-000-367	1AJ18R0XXX4546XJA
		Nickel spiegelpol. Plus - Pol. Nickel Plus 	992-164-000-004	1AJ18R0XXX45K1XJA



	Bezeichnung - Description	Farbe - Finishes	Alte Art.-Nr. - Old code	1 Stück - Piece
	Paar Rosetten mit Stütznocken + Schrauben M5x50 mit BB Lochung <i>Pair rosettes with support cams + screws M5x50 key hole</i>	Chrom - Polished chrome	371-154-400-000	1A000CDJ302B05XJA
		Schwarz RAL 9005 - Matt black RAL 9005	-	1A000CDJ302B18XJA
		Ultra Messing - PVD Gold	-	1A000CDJ302B46XJA
		Edelstahl - Stainless steel 304	371-154-400-055	1A000CDJ302B5SXJA
		Nickel spiegelpol. Plus - Pol. Nickel Plus	-	1A000CDJ302BK1XJA
	Paar Rosetten mit Stütznocken + Schrauben M5x50 ohne Loch <i>Pair rosettes with support cams + screws M5x50 without key hole</i>	Chrom - Polished chrome	371-154-300-000	1A000CDJ302C05XJA
		Schwarz RAL 9005 - Matt black RAL 9005	-	1A000CDJ302C18XJA
		Ultra Messing - PVD Gold	-	1A000CDJ302C46XJA
		Edelstahl - Stainless steel 304	371-154-300-055	1A000CDJ302C5SXJA
		Nickel spiegelpol. Plus - Pol. Nickel Plus	-	1A000CDJ302CK1XJA
	Paar Rosetten mit Stütznocken + Schrauben M5x50 mit Drückerlochung <i>Pair rosettes with support cams + screws M5x50 lever handle hole</i>	Chrom - Polished chrome	371-164-400-000	1A000CDJ302M05XJA
		Schwarz RAL 9005 - Matt black RAL 9005	-	1A000CDJ302M18XJA
		Ultra Messing - PVD Gold	-	1A000CDJ302M46XJA
		Edelstahl - Stainless steel 304	371-164-400-055	1A000CDJ302M5SXJA
		Nickel spiegelpol. Plus - Pol. Nickel Plus	-	1A000CDJ302MK1XJA
	Paar Rosetten mit Stütznocken + Schrauben M5x50 mit PZ Lochung <i>Pair rosettes with support cams + screws M5x50 Euro profile hole</i>	Chrom - Polished chrome	371-154-500-000	1A000CDJ302Y05XJA
		Schwarz RAL 9005 - Matt black RAL 9005	371-154-500-180	1A000CDJ302Y18XJA
		Ultra Messing - PVD Gold	-	1A000CDJ302Y46XJA
		Edelstahl - Stainless steel 304	371-154-500-055	1A000CDJ302Y5SXJA
		Nickel spiegelpol. Plus - Pol. Nickel Plus	-	1A000CDJ302YK1XJA
	Schlüsselrosette blind 52x52x9 mm <i>Escutcheon without key hole 52x52x9 mm</i>	Chrom - Polished chrome	371-153-000-000	1AJ30BCXXXXX05XJA
		Schwarz RAL 9005 - Matt black RAL 9005	-	1AJ30BCXXXXX18XJA
		Ultra Messing - PVD Gold	-	1AJ30BCXXXXX46XJA
		Edelstahl - Stainless steel 304	371-153-000-055	1AJ30BCXXXXX5SXJA
		Nickel spiegelpol. Plus - Pol. Nickel Plus	-	1AJ30BCXXXXXK1XJA
	Schlüsselrosette blind 52x52x9 mm mit M5 Gewindenocken und Schrauben M5x50 <i>Escutcheon without key hole 52x52x9 mm with 2 threads + screws M5x50</i>	Chrom - Polished chrome	371-154-000-000	1AJ30BCXXX4505XJA
		Schwarz RAL 9005 - Matt black RAL 9005	-	1AJ30BCXXX4518XJA
		Ultra Messing - PVD Gold	-	1AJ30BCXXX4546XJA
		Edelstahl - Stainless steel 304	371-154-000-055	1AJ30BCXXX455SXJA
		Nickel spiegelpol. Plus - Pol. Nickel Plus	-	1AJ30BCXXX45K1XJA
	Schlüsselrosette BB 52x52x9 mm <i>Key escutcheon 52x52x9 mm</i>	Chrom - Polished chrome	371-153-100-000	1AJ30BNXXXXX05XJA
		Schwarz RAL 9005 - Matt black RAL 9005	-	1AJ30BNXXXXX18XJA
		Ultra Messing - PVD Gold	-	1AJ30BNXXXXX46XJA
		Edelstahl - Stainless steel 304	371-153-100-055	1AJ30BNXXXXX5SXJA
		Nickel spiegelpol. Plus - Pol. Nickel Plus	-	1AJ30BNXXXXXK1XJA
	Schlüsselrosette BB 52x52x9 mm mit M5 Gewindenocken und Schrauben M5x50 <i>Key escutcheon 52x52x9 mm with M5 threads and screws M5x50</i>	Chrom - Polished chrome	371-154-100-000	1AJ30BNXXX4505XJA
		Schwarz RAL 9005 - Matt black RAL 9005	-	1AJ30BNXXX4518XJA
		Ultra Messing - PVD Gold	371-154-100-367	1AJ30BNXXX4546XJA
		Edelstahl - Stainless steel 304	371-154-100-055	1AJ30BNXXX455SXJA
		Nickel spiegelpol. Plus - Pol. Nickel Plus	-	1AJ30BNXXX45K1XJA
	Schlüsselrosette PZ 52x52x9 mm <i>Euro profile escutcheon 52x52x9 mm</i>	Chrom - Polished chrome	371-153-200-000	1AJ30BYXXXXX05XJA
		Schwarz RAL 9005 - Matt black RAL 9005	371-153-200-180	1AJ30BYXXXXX18XJA
		Ultra Messing - PVD Gold	-	1AJ30BYXXXXX46XJA
		Edelstahl - Stainless steel 304	371-153-200-055	1AJ30BYXXXXX5SXJA
		Nickel spiegelpol. Plus - Pol. Nickel Plus	-	1AJ30BYXXXXXK1XJA

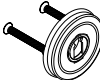

	Bezeichnung - Description	Farbe - Finishes	Alte Art.-Nr. - Old code	1 Stück - Piece
	Schlüsselrosette PZ 52x52x9 mm mit M5 Gewindenocken und Schrauben M5x50 <i>Euro profile escutcheon 52x52x9 mm with M5 threads and screws M5x50</i>	Chrom - Polished chrome	371-154-200-000	1AJ30BYXXX4505XJA
		Schwarz RAL 9005 - Matt black RAL 9005	371-154-200-180	1AJ30BYXXX4518XJA
		Ultra Messing - PVD Gold	-	1AJ30BYXXX4546XJA
		Edelstahl - Stainless steel 304	371-154-200-055	1AJ30BYXXX455SXJA
		Nickel spiegelpol. Plus - Pol. Nickel Plus	-	1AJ30BYXXX45K1XJA
	Rosette 52x52x9 mm für Knöpfe mit M5 Gewindenocken und Schrauben M5x50 <i>Rose 52x52x9 mm for knobs with M5 threads and screws M5x50</i>	Chrom - Polished chrome	371-064-000-000	1AJ30R00FP4505XJA
		Schwarz RAL 9005 - Matt black RAL 9005	-	1AJ30R00FP4518XJA
		Ultra Messing - PVD Gold	371-064-000-367	1AJ30R00FP4546XJA
		Edelstahl - Stainless steel 304	371-064-000-055	1AJ30R00FP455SXJA
		Nickel spiegelpol. Plus - Pol. Nickel Plus	371-064-000-004	1AJ30R00FP45K1XJA
	Rosette 52x52x9 mm <i>Rose 52x52x9 mm</i>	Chrom - Polished chrome	371-163-000-000	1AJ30R0XXXXX05XJA
		Schwarz RAL 9005 - Matt black RAL 9005	-	1AJ30R0XXXXX18XJA
		Ultra Messing - PVD Gold	-	1AJ30R0XXXXX46XJA
		Edelstahl - Stainless steel 304	371-163-000-055	1AJ30R0XXXXX5SXJA
		Nickel spiegelpol. Plus - Pol. Nickel Plus	-	1AJ30R0XXXXXK1XJA
	Rosette 52x52x9 mm mit M5 Gewindenocken und Schrauben M5x50 <i>Rose 52x52x9 mm with M5 threads and screws M5x50</i>	Chrom - Polished chrome	371-164-000-000	1AJ30R0XXX4505XJA
		Schwarz RAL 9005 - Matt black RAL 9005	371-164-000-180	1AJ30R0XXX4518XJA
		Ultra Messing - PVD Gold	371-164-000-367	1AJ30R0XXX4546XJA
		Edelstahl - Stainless steel 304	371-164-000-055	1AJ30R0XXX455SXJA
		Nickel spiegelpol. Plus - Pol. Nickel Plus	371-164-000-004	1AJ30R0XXX45K1XJA

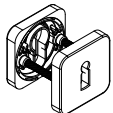
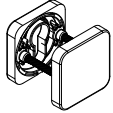
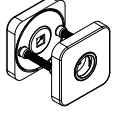
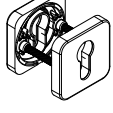
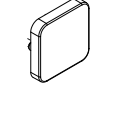
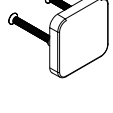
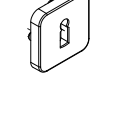
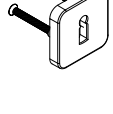
	Bezeichnung - Description	Farbe - Finishes	Alte Art.-Nr. - Old code	1 Stück - Piece
	Paar Rosetten mit Stütznocken + Schrauben M5x50 mit BB Lochung <i>Pair rosettes with support cams + screws M5x50 key hole</i>	Chrom - Polished chrome	428-154-400-000	1A000CDJ362B05XJA
		Messing Rustik - Rustic brass	428-154-400-01M	1A000CDJ362B1MXJA
		Ultra Messing - PVD Gold	428-154-400-367	1A000CDJ362B46XJA
		Antik Nickel - Antique Nickel	428-154-400-444	1A000CDJ362B8BXJA
		Ultra Mattnickel - PVD Satin inox	428-154-400-066	1A000CDJ362B98XJA
	Paar Rosetten mit Stütznocken + Schrauben M5x50 ohne Loch <i>Pair rosettes with support cams + screws M5x50 without key hole</i>	Chrom - Polished chrome	428-154-300-000	1A000CDJ362C05XJA
		Messing Rustik - Rustic brass	428-154-300-01M	1A000CDJ362C1MXJA
		Ultra Messing - PVD Gold	428-154-300-367	1A000CDJ362C46XJA
		Antik Nickel - Antique Nickel	428-154-300-444	1A000CDJ362C8BXJA
		Ultra Mattnickel - PVD Satin inox	428-154-300-066	1A000CDJ362C98XJA
	Paar Rosetten mit Stütznocken + Schrauben M5x50 mit Druckerlochung <i>Pair rosettes with support cams + screws M5x50 lever handle hole</i>	Chrom - Polished chrome	428-164-400-000	1A000CDJ362M05XJA
		Messing Rustik - Rustic brass	428-164-400-01M	1A000CDJ362M1MXJA
		Ultra Messing - PVD Gold	428-164-400-367	1A000CDJ362M46XJA
		Antik Nickel - Antique Nickel	428-164-400-444	1A000CDJ362M8BXJA
		Ultra Mattnickel - PVD Satin inox	428-164-400-066	1A000CDJ362M98XJA
	Paar Rosetten mit Stütznocken + Schrauben M5x50 mit PZ Lochung <i>Pair rosettes with support cams + screws M5x50 Euro profile hole</i>	Chrom - Polished chrome	428-154-500-000	1A000CDJ362Y05XJA
		Messing Rustik - Rustic brass	428-154-500-01M	1A000CDJ362Y1MXJA
		Ultra Messing - PVD Gold	428-154-500-367	1A000CDJ362Y46XJA
		Antik Nickel - Antique Nickel	428-154-500-444	1A000CDJ362Y8BXJA
		Ultra Mattnickel - PVD Satin inox	428-154-500-066	1A000CDJ362Y98XJA
	Schlüsselrosette blind Ø55x9 mm <i>Escutcheon without key hole Ø55x9 mm</i>	Chrom - Polished chrome	428-153-000-000	1AJ36BCXXXXX05XJA
		Messing Rustik - Rustic brass	428-153-000-01M	1AJ36BCXXXXX1MXJA
		Ultra Messing - PVD Gold	428-153-000-367	1AJ36BCXXXXX46XJA
		Antik Nickel - Antique Nickel	428-153-000-444	1AJ36BCXXXXX8BXJA
		Ultra Mattnickel - PVD Satin inox	428-153-000-066	1AJ36BCXXXXX98XJA
	Schlüsselrosette blind Ø55x9 mm mit M5 Gewindenocken und Schrauben M5x50 <i>Escutcheon without key hole Ø55x9 mm with 2 threads + screws M5x50</i>	Chrom - Polished chrome	428-154-000-000	1AJ36BCXXX4505XJA
		Messing Rustik - Rustic brass	428-154-000-01M	1AJ36BCXXX451MXJA
		Ultra Messing - PVD Gold	428-154-000-367	1AJ36BCXXX4546XJA
		Antik Nickel - Antique Nickel	428-154-000-444	1AJ36BCXXX458BXJA
		Ultra Mattnickel - PVD Satin inox	428-154-000-066	1AJ36BCXXX4598XJA
	Schlüsselrosette BB Ø55x9 mm <i>Key escutcheon Ø55x9 mm</i>	Chrom - Polished chrome	428-153-100-000	1AJ36BNXXXXX05XJA
		Messing Rustik - Rustic brass	428-153-100-01M	1AJ36BNXXXXX1MXJA
		Ultra Messing - PVD Gold	428-153-100-367	1AJ36BNXXXXX46XJA
		Antik Nickel - Antique Nickel	428-153-100-444	1AJ36BNXXXXX8BXJA
		Ultra Mattnickel - PVD Satin inox	428-153-100-066	1AJ36BNXXXXX98XJA
	Schlüsselrosette BB Ø55x9 mm mit M5 Gewindenocken und Schrauben M5x50 <i>Key escutcheon Ø55x9 mm with M5 threads and screws M5x50</i>	Chrom - Polished chrome	428-154-100-000	1AJ36BNXXX4505XJA
		Messing Rustik - Rustic brass	428-154-100-01M	1AJ36BNXXX451MXJA
		Ultra Messing - PVD Gold	428-154-100-367	1AJ36BNXXX4546XJA
		Antik Nickel - Antique Nickel	428-154-100-444	1AJ36BNXXX458BXJA
		Ultra Mattnickel - PVD Satin inox	428-154-100-066	1AJ36BNXXX4598XJA
	Schlüsselrosette PZ Ø55x9 mm <i>Euro profile escutcheon Ø55x9 mm</i>	Chrom - Polished chrome	428-153-200-000	1AJ36BYXXXXX05XJA
		Messing Rustik - Rustic brass	428-153-200-01M	1AJ36BYXXXXX1MXJA
		Ultra Messing - PVD Gold	428-153-200-367	1AJ36BYXXXXX46XJA
		Antik Nickel - Antique Nickel	428-153-200-444	1AJ36BYXXXXX8BXJA
		Ultra Mattnickel - PVD Satin inox	428-153-200-066	1AJ36BYXXXXX98XJA

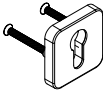
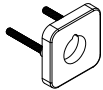

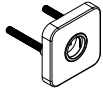
	Bezeichnung - Description	Farbe - Finishes	Alte Art.-Nr. - Old code	1 Stück - Piece
	Schlüsselrosette PZ Ø55x9 mm mit M5 Gewindenocken und Schrauben M5x50 <i>Euro profile escutcheon Ø55x9 mm with M5 threads and screws M5x50</i>	Chrom - Polished chrome	428-154-200-000	1AJ36BYXXX4505XJA
		Messing Rustik - Rustic brass	428-154-200-01M	1AJ36BYXXX451MXJA
		Ultra Messing - PVD Gold 	428-154-200-367	1AJ36BYXXX4546XJA
		Antik Nickel - Antique Nickel	428-154-200-444	1AJ36BYXXX458BXJA
		Ultra Mattnickel - PVD Satin inox 	428-154-200-066	1AJ36BYXXX4598XJA
	Rosette Ø55x9 mm für Knöpfe mit M5 Gewindenocken und Schrauben M5x50 <i>Rose Ø55x9 mm for knobs with M5 threads and screws M5x50</i>	Chrom - Polished chrome	428-064-000-000	1AJ36R00FP4505XJA
		Messing Rustik - Rustic brass	428-064-000-01M	1AJ36R00FP451MXJA
		Ultra Messing - PVD Gold 	428-064-000-367	1AJ36R00FP4546XJA
		Antik Nickel - Antique Nickel	428-064-000-444	1AJ36R00FP458BXJA
		Ultra Mattnickel - PVD Satin inox 	428-064-000-066	1AJ36R00FP4598XJA
	Rosette Ø55x9 mm <i>Rose Ø55x9 mm</i>	Chrom - Polished chrome	428-163-000-000	1AJ36R0XXXXX05XJA
		Messing Rustik - Rustic brass	428-163-000-01M	1AJ36R0XXXXX1MXJA
		Ultra Messing - PVD Gold 	428-163-000-367	1AJ36R0XXXXX46XJA
		Antik Nickel - Antique Nickel	428-163-000-444	1AJ36R0XXXXX8BXJA
		Ultra Mattnickel - PVD Satin inox 	428-163-000-066	1AJ36R0XXXXX98XJA
	Rosette Ø55x9 mm mit M5 Gewindenocken und Schrauben M5x50 <i>Rose Ø55x9 mm with M5 threads and screws M5x50</i>	Chrom - Polished chrome	428-164-000-000	1AJ36R0XXX4505XJA
		Messing Rustik - Rustic brass	428-164-000-01M	1AJ36R0XXX451MXJA
		Ultra Messing - PVD Gold 	428-164-000-367	1AJ36R0XXX4546XJA
		Antik Nickel - Antique Nickel	428-164-000-444	1AJ36R0XXX458BXJA
		Ultra Mattnickel - PVD Satin inox 	428-164-000-066	1AJ36R0XXX4598XJA

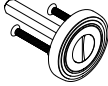

	Bezeichnung - Description	Farbe - Finishes	Alte Art.-Nr. - Old code	1 Stück - Piece
	Paar Rosetten mit Stütznocken + Schrauben M5x50 mit BB Lochung <i>Pair rosettes with support cams + screws M5x50 key hole</i>	Chrom - Polished chrome	388-154-400-000	1A000CDJ372B05XJA
		Schwarz RAL 9005 - Matt black RAL 9005	388-154-400-180	1A000CDJ372B18XJA
		Edelstahl - Stainless steel 304	388-154-400-055	1A000CDJ372B5SXJA
	Paar Rosetten mit Stütznocken + Schrauben M5x50 ohne Loch <i>Pair rosettes with support cams + screws M5x50 without key hole</i>	Chrom - Polished chrome	388-154-300-000	1A000CDJ372C05XJA
		Schwarz RAL 9005 - Matt black RAL 9005	388-154-300-180	1A000CDJ372C18XJA
		Edelstahl - Stainless steel 304	388-154-300-055	1A000CDJ372C5SXJA
	Paar Rosetten mit Stütznocken + Schrauben M5x50 mit Drückerlochung <i>Pair rosettes with support cams + screws M5x50 lever handle hole</i>	Chrom - Polished chrome	388-164-400-000	1A000CDJ372M05XJA
		Schwarz RAL 9005 - Matt black RAL 9005	388-164-400-180	1A000CDJ372M18XJA
		Edelstahl - Stainless steel 304	388-164-400-055	1A000CDJ372M5SXJA
	Paar Rosetten mit Stütznocken + Schrauben M5x50 mit PZ Lochung <i>Pair rosettes with support cams + screws M5x50 Euro profile hole</i>	Chrom - Polished chrome	388-154-500-000	1A000CDJ372Y05XJA
		Schwarz RAL 9005 - Matt black RAL 9005	388-154-500-180	1A000CDJ372Y18XJA
		Edelstahl - Stainless steel 304	388-154-500-055	1A000CDJ372Y5SXJA
	Schlüsselrosette blind 52x52x9 mm <i>Escutcheon without key hole 52x52x9 mm</i>	Chrom - Polished chrome	388-153-000-000	1AJ37BCXXXXX05XJA
		Schwarz RAL 9005 - Matt black RAL 9005	388-153-000-180	1AJ37BCXXXXX18XJA
		Edelstahl - Stainless steel 304	388-153-000-055	1AJ37BCXXXXX5SXJA
	Schlüsselrosette blind 52x52x9 mm mit M5 Gewindenocken und Schrauben M5x50 <i>Escutcheon without key hole 52x52x9 mm with 2 threads + screws M5x50</i>	Chrom - Polished chrome	388-154-000-000	1AJ37BCXXX4505XJA
		Schwarz RAL 9005 - Matt black RAL 9005	388-154-000-180	1AJ37BCXXX4518XJA
		Edelstahl - Stainless steel 304	388-154-000-055	1AJ37BCXXX455SXJA
	Schlüsselrosette BB 52x52x9 mm <i>Key escutcheon 52x52x9 mm</i>	Chrom - Polished chrome	388-153-100-000	1AJ37BNXXXXX05XJA
		Schwarz RAL 9005 - Matt black RAL 9005	388-153-100-180	1AJ37BNXXXXX18XJA
		Edelstahl - Stainless steel 304	388-153-100-055	1AJ37BNXXXXX5SXJA
	Schlüsselrosette BB 52x52x9 mm mit M5 Gewindenocken und Schrauben M5x50 <i>Key escutcheon 52x52x9 mm with M5 threads and screws M5x50</i>	Chrom - Polished chrome	388-154-100-000	1AJ37BNXXX4505XJA
		Schwarz RAL 9005 - Matt black RAL 9005	388-154-100-180	1AJ37BNXXX4518XJA
		Edelstahl - Stainless steel 304	388-154-100-055	1AJ37BNXXX455SXJA

	Bezeichnung - Description	Farbe - Finishes	Alte Art.-Nr. - Old code	1 Stück - Piece
	Schlüsselrosette PZ 52x52x9 mm Euro profile escutcheon 52x52x9 mm	Chrom - Polished chrome	388-153-200-000	1AJ37BYXXXX05XJA
		Schwarz RAL 9005 - Matt black RAL 9005	388-153-200-180	1AJ37BYXXXX18XJA
		Edelstahl - Stainless steel 304	388-153-200-055	1AJ37BYXXXX5SXJA
	Schlüsselrosette PZ 52x52x9 mm mit M5 Gewindenocken und Schrauben M5x50 Euro profile escutcheon 52x52x9 mm with M5 threads and screws M5x50	Chrom - Polished chrome	388-154-200-000	1AJ37BYXXX4505XJA
		Schwarz RAL 9005 - Matt black RAL 9005	388-154-200-180	1AJ37BYXXX4518XJA
		Edelstahl - Stainless steel 304	388-154-200-055	1AJ37BYXXX455SXJA
	Rosette 52x52x9 mm für Knöpfe mit M5 Gewindenocken und Schrauben M5x50 Rose 52x52x9 mm for knobs with M5 threads and screws M5x50	Chrom - Polished chrome	388-164-100-000	1AJ37R00FP4505XJA
		Schwarz RAL 9005 - Matt black RAL 9005	388-164-100-180	1AJ37R00FP4518XJA
		Edelstahl - Stainless steel 304	388-164-100-055	1AJ37R00FP455SXJA
	Rosette 52x52x9 mm Rose 52x52x9 mm	Chrom - Polished chrome	388-163-000-000	1AJ37R0XXXX05XJA
		Schwarz RAL 9005 - Matt black RAL 9005	388-163-000-180	1AJ37R0XXXX18XJA
		Edelstahl - Stainless steel 304	388-163-000-055	1AJ37R0XXXX5SXJA
	Rosette 52x52x9 mm mit M5 Gewindenocken und Schrauben M5x50 Rose 52x52x9 mm with M5 threads and screws M5x50	Chrom - Polished chrome	388-164-000-000	1AJ37R0XXX4505XJA
		Schwarz RAL 9005 - Matt black RAL 9005	388-164-000-180	1AJ37R0XXX4518XJA
		Edelstahl - Stainless steel 304	388-164-000-055	1AJ37R0XXX455SXJA

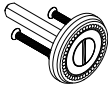

	Bezeichnung - Description	Farbe - Finishes	Alte Art.-Nr. - Old code	1 Stück - Piece
 <p>WC-Rosettenpaar mit Riegel und Schlitzschraube Ø55x9 mm mit 8mm VK</p> <p>WC turn and release on rose Ø55x9 mm with 8mm spindle</p>	Chrom - Polished chrome		993-991-900-000	1AJ01NOJ035205XJA
	Ultra Messing - PVD Gold		993-991-900-367	1AJ01NOJ035246XJA
	Edelstahl Spiegelpol. - Polished Stainless Steel		-	1AJ01NOJ035250XJA
	Edelstahl - Stainless steel 304		993-991-900-055	1AJ01NOJ03525SXJA
	Antik Nickel - Antique Nickel		993-991-900-444	1AJ01NOJ03528BXJA
	Ultra Mattnickel - PVD Satin inox		993-991-900-066	1AJ01NOJ035298XJA
 <p>WC-Rosette mit Schlitzschraube Ø55x9 mm 8mm VK</p> <p>WC emergency release only on rose Ø55x9 mm with 8 mm spindle</p>	Chrom - Polished chrome		993-991-600-000	1AJ01RIJ035205XJA
	Ultra Messing - PVD Gold		993-991-600-367	1AJ01RIJ035246XJA
	Edelstahl Spiegelpol. - Polished Stainless Steel		-	1AJ01RIJ035250XJA
	Edelstahl - Stainless steel 304		993-991-600-055	1AJ01RIJ03525SXJA
	Antik Nickel - Antique Nickel		993-991-600-444	1AJ01RIJ03528BXJA
	Ultra Mattnickel - PVD Satin inox		993-991-600-066	1AJ01RIJ035298XJA
 <p>WC-Rosette mit Riegel Ø55x9 mm</p> <p>WC turn only on rose Ø55x9 mm</p>	Chrom - Polished chrome		993-991-700-000	1AJ01SPJ035205XJA
	Ultra Messing - PVD Gold		993-991-700-367	1AJ01SPJ035246XJA
	Edelstahl Spiegelpol. - Polished Stainless Steel		-	1AJ01SPJ035250XJA
	Edelstahl - Stainless steel 304		993-991-700-055	1AJ01SPJ03525SXJA
	Antik Nickel - Antique Nickel		993-991-700-444	1AJ01SPJ03528BXJA
	Ultra Mattnickel - PVD Satin inox		993-991-700-066	1AJ01SPJ035298XJA

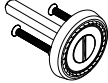

J01 NO J13

	Bezeichnung - Description	Farbe - Finishes	Alte Art.-Nr. - Old code	1 Stück - Piece
 <p>WC-Rosettenpaar mit Riegel und Schlitzschraube Ø55x10 mm mit 8mm VK</p> <p>WC turn and release on rose Ø55x10 mm with 8mm spindle</p>	Chrom - Polished chrome		984-991-E00-000	1AJ01NOJ135205XJA
	Ultra Messing - PVD Gold		984-991-E00-367	1AJ01NOJ135246XJA
	Antik Nickel - Antique Nickel		984-991-E00-444	1AJ01NOJ13528BXJA
 <p>WC-Rosette mit Schlitzschraube Ø55x10 mm 8mm VK</p> <p>WC emergency release only on rose Ø55x10 mm with 8 mm spindle</p>	Chrom - Polished chrome		984-991-D00-000	1AJ01RIJ135205XJA
	Ultra Messing - PVD Gold		984-991-D00-367	1AJ01RIJ135246XJA
	Antik Nickel - Antique Nickel		984-991-D00-444	1AJ01RIJ13528BXJA
 <p>WC-Rosette mit Riegel Ø55x10 mm</p> <p>WC turn only on rose Ø55x10 mm</p>	Chrom - Polished chrome		984-991-C00-000	1AJ01SPJ135205XJA
	Ultra Messing - PVD Gold		984-991-C00-367	1AJ01SPJ135246XJA
	Antik Nickel - Antique Nickel		984-991-C00-444	1AJ01SPJ13528BXJA

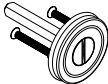



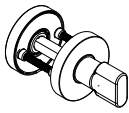
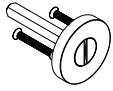





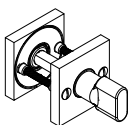

	Bezeichnung - Description	Farbe - Finishes	Alte Art.-Nr. - Old code	1 Stück - Piece
 <p>WC-Rosettenpaar mit Riegel und Schlitzschraube Ø54x10 mm mit 8mm VK</p> <p><i>WC turn and release on rose Ø54x10 mm with 8mm spindle</i></p>		Chrom - Polished chrome	992-991-900-000	1AJ01NOJ185205XJA
		Ultra Messing - PVD Gold	992-991-900-367	1AJ01NOJ185246XJA
		Nickel spiegelpol. Plus - Pol. Nickel Plus	992-991-900-004	1AJ01NOJ1852K1XJA
 <p>WC-Rosette mit Schlitzschraube Ø55x10 mm 8mm VK</p> <p><i>WC emergency release only on rose Ø55x10 mm with 8 mm spindle</i></p>		Chrom - Polished chrome	992-991-600-000	1AJ01RIJ185205XJA
		Ultra Messing - PVD Gold	992-991-600-367	1AJ01RIJ185246XJA
		Nickel spiegelpol. Plus - Pol. Nickel Plus	992-991-600-004	1AJ01RIJ1852K1XJA
 <p>WC-Rosette mit Riegel Ø55x10 mm</p> <p><i>WC turn only on rose Ø55x10 mm</i></p>		Chrom - Polished chrome	992-991-700-000	1AJ01SPJ185205XJA
		Ultra Messing - PVD Gold	992-991-700-367	1AJ01SPJ185246XJA
		Nickel spiegelpol. Plus - Pol. Nickel Plus	992-991-700-004	1AJ01SPJ1852K1XJA

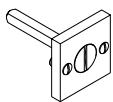

J01 NO J36

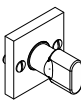
	Bezeichnung - Description	Farbe - Finishes	Alte Art.-Nr. - Old code	1 Stück - Piece
 <p>WC-Rosettenpaar mit Riegel und Schlitzschraube Ø55x9 mm mit 8mm VK</p> <p><i>WC turn and release on rose Ø55x9 mm with 8mm spindle</i></p>		Chrom - Polished chrome	428-991-600-000	1AJ01NOJ365205XJA
		Messing Rustik - Rustic brass	428-991-600-01M	1AJ01NOJ36521MXJA
		Ultra Messing - PVD Gold	428-991-600-367	1AJ01NOJ365246XJA
		Antik Nickel - Antique Nickel	428-991-600-444	1AJ01NOJ36528BXJA
		Ultra Mattnickel - PVD Satin inox	428-991-600-066	1AJ01NOJ365298XJA
 <p>WC-Rosette mit Schlitzschraube Ø55x10 mm 8mm VK</p> <p><i>WC emergency release only on rose Ø55x10 mm with 8 mm spindle</i></p>		Chrom - Polished chrome	428-991-400-000	1AJ01RIJ365205XJA
		Messing Rustik - Rustic brass	428-991-400-01M	1AJ01RIJ36521MXJA
		Ultra Messing - PVD Gold	428-991-400-367	1AJ01RIJ365246XJA
		Antik Nickel - Antique Nickel	428-991-400-444	1AJ01RIJ36528BXJA
		Ultra Mattnickel - PVD Satin inox	428-991-400-066	1AJ01RIJ365298XJA
 <p>WC-Rosette mit Riegel Ø55x10 mm</p> <p><i>WC turn only on rose Ø55x10 mm</i></p>		Chrom - Polished chrome	428-991-300-000	1AJ01SPJ365205XJA
		Messing Rustik - Rustic brass	428-991-300-01M	1AJ01SPJ36521MXJA
		Ultra Messing - PVD Gold	428-991-300-367	1AJ01SPJ365246XJA
		Antik Nickel - Antique Nickel	428-991-300-444	1AJ01SPJ36528BXJA
		Ultra Mattnickel - PVD Satin inox	428-991-300-066	1AJ01SPJ365298XJA

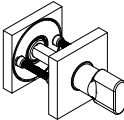
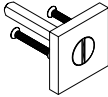

	Bezeichnung - Description	Farbe - Finishes	Alte Art.-Nr. - Old code	1 Stück - Piece
	WC-Rosettenpaar mit Riegel und Schlitzschraube Ø52x9 mm mit 8mm VK WC turn and release on rose Ø52x9 mm with 8mm spindle	Chrom - Polished chrome	373-455-600-000	1AJ02NOJ015205XJA
		Schwarz RAL 9005 - Matt black RAL 9005	-	1AJ02NOJ015218XJA
		Edelstahl - Stainless steel 304	373-455-600-055	1AJ02NOJ01525SXJA
	WC-Rosette mit Schlitzschraube Ø55x10 mm 8mm VK WC emergency release only on rose Ø55x10 mm with 8 mm spindle	Chrom - Polished chrome	373-991-400-000	1AJ01RIJ015205XJA
		Schwarz RAL 9005 - Matt black RAL 9005	-	1AJ01RIJ015218XJA
		Edelstahl - Stainless steel 304	373-991-400-055	1AJ01RIJ01525SXJA
	WC-Rosette mit Riegel Ø55x10 mm WC turn only on rose Ø55x10 mm	Chrom - Polished chrome	373-455-300-000	1AJ02SPJ015205XJA
		Schwarz RAL 9005 - Matt black RAL 9005	373-455-300-180	1AJ02SPJ015218XJA
		Edelstahl - Stainless steel 304	373-455-300-055	1AJ02SPJ01525SXJA

JO1 RI JO4

	Bezeichnung - Description	Farbe - Finishes	Alte Art.-Nr. - Old code	1 Stück - Piece
	WC-Rosettenpaar mit Riegel und Schlitzschraube Ø52x52x9 mm mit 8mm VK WC turn and release on rose 52x52x9 mm with 8mm spindle	Chrom - Polished chrome	963-455-600-000	1AJ02NOJ045205XJA
		Ultra Messing - PVD Gold 	963-455-600-367	1AJ02NOJ045246XJA
		Ultra Mattnickel - PVD Satin inox 	963-455-600-066	1AJ02NOJ045298XJA
		Nickel spiegelpol. Plus - Pol. Nickel Plus 	963-455-600-004	1AJ02NOJ0452K1XJA
	WC-Rosette mit Schlitzschraube 52x52x9 mm 8mm VK WC emergency release only on rose 52x52x9 mm with 8 mm spindle	Chrom - Polished chrome	963-991-400-000	1AJ01RIJ045205XJA
		Ultra Messing - PVD Gold 	963-991-400-367	1AJ01RIJ045246XJA
		Ultra Mattnickel - PVD Satin inox 	963-991-400-066	1AJ01RIJ045298XJA
		Nickel spiegelpol. Plus - Pol. Nickel Plus 	963-991-400-004	1AJ01RIJ0452K1XJA
	WC-Rosette mit Riegel 52x52x9 mm WC turn only on rose 52x52x9 mm	Chrom - Polished chrome	963-455-300-000	1AJ02SPJ045205XJA
		Ultra Messing - PVD Gold 	963-455-300-367	1AJ02SPJ045246XJA
		Ultra Mattnickel - PVD Satin inox 	963-455-300-066	1AJ02SPJ045298XJA
		Nickel spiegelpol. Plus - Pol. Nickel Plus 	963-455-300-004	1AJ02SPJ0452K1XJA



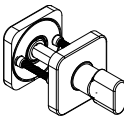
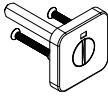

	Bezeichnung - Description	Farbe - Finishes	Alte Art.-Nr. - Old code	1 Stück - Piece
	WC-Rosettenpaar mit Riegel und Schlitzschraube Ø52x52x9 mm mit 8mm VK WC turn and release on rose 52x52x9 mm with 8mm spindle	Chrom - Polished chrome	371-455-600-000	1AJ02NOJ305205XJA
		Schwarz RAL 9005 - Matt black RAL 9005	-	1AJ02NOJ305218XJA
		Edelstahl - Stainless steel 304	371-455-600-055	1AJ02NOJ30525SXJA
		Nickel spiegelpol. Plus - Pol. Nickel Plus	-	1AJ02NOJ3052K1XJA
	WC-Rosette mit Schlitzschraube 52x52x9 mm 8mm VK WC emergency release only on rose 52x52x9 mm with 8 mm spindle	Chrom - Polished chrome	371-991-400-000	1AJ01RIJ305205XJA
		Schwarz RAL 9005 - Matt black RAL 9005	-	1AJ01RIJ305218XJA
		Edelstahl - Stainless steel 304	371-991-400-055	1AJ01RIJ30525SXJA
		Nickel spiegelpol. Plus - Pol. Nickel Plus	-	1AJ01RIJ3052K1XJA
	WC-Rosette mit Riegel 52x52x9 mm WC turn only on rose 52x52x9 mm	Chrom - Polished chrome	371-455-300-000	1AJ02SPJ305205XJA
		Schwarz RAL 9005 - Matt black RAL 9005	-	1AJ02SPJ305218XJA
		Edelstahl - Stainless steel 304	371-455-300-055	1AJ02SPJ30525SXJA

J01 RI J37



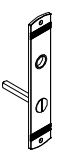

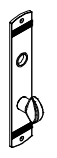

	Bezeichnung - Description	Farbe - Finishes	Alte Art.-Nr. - Old code	1 Stück - Piece
	WC-Rosettenpaar mit Riegel und Schlitzschraube Ø52x52x9 mm mit 8mm VK WC turn and release on rose 52x52x9 mm with 8mm spindle	Chrom - Polished chrome	388-455-600-000	1AJ02NOJ375205XJA
		Schwarz RAL 9005 - Matt black RAL 9005	388-455-600-180	1AJ02NOJ375218XJA
		Edelstahl - Stainless steel 304	388-455-600-055	1AJ02NOJ37525SXJA
	WC-Rosette mit Schlitzschraube 52x52x9 mm 8mm VK WC emergency release only on rose 52x52x9 mm with 8 mm spindle	Chrom - Polished chrome	388-991-400-000	1AJ01RIJ375205XJA
		Schwarz RAL 9005 - Matt black RAL 9005	388-991-400-180	1AJ01RIJ375218XJA
		Edelstahl - Stainless steel 304	388-991-400-055	1AJ01RIJ37525SXJA
	WC-Rosette mit Riegel 52x52x9 mm WC turn only on rose 52x52x9 mm	Chrom - Polished chrome	388-455-300-000	1AJ02SPJ375205XJA
		Schwarz RAL 9005 - Matt black RAL 9005	388-455-300-180	1AJ02SPJ375218XJA
		Edelstahl - Stainless steel 304	388-455-300-055	1AJ02SPJ37525SXJA

	Bezeichnung - Description	Farbe - Finishes	Alte Art.-Nr. - Old code	1 Stück - Piece
	WC Schild 52x245 mm mit Schlitzschraube 8mm VK WC emergency release only on plate mm 52x245 (8mm WC spindle)	Chrom - Polished chrome	710-991-200-000	1AJ01WI7102405XJA
		Ultra Messing - PVD Gold 	710-991-200-367	1AJ01WI7102446XJA
	WC Schild 52x245 mm mit Riegel WC turn only on plate mm 52x245	Chrom - Polished chrome	710-991-100-000	1AJ01WN7102405XJA
		Ultra Messing - PVD Gold 	710-991-100-367	1AJ01WN7102446XJA

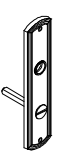
JO1 WI JO1



	Bezeichnung - Description	Farbe - Finishes	Alte Art.-Nr. - Old code	1 Stück - Piece
	WC Schild 43x231 mm mit Schlitzschraube 8mm VK WC emergency release only on plate mm 43x231 (8mm WC spindle)	Chrom - Polished chrome	354-991-200-000	1AJ01WIJ012405XJA
		Ultra Messing - PVD Gold 	354-991-200-367	1AJ01WIJ012446XJA
		Ultra Mattnickel - PVD Satin inox 	354-991-200-066	1AJ01WIJ012498XJA
	WC Schild 43x231 mm mit Riegel WC turn only on plate mm 43x231	Chrom - Polished chrome	354-991-100-000	1AJ01WNJ012405XJA
		Ultra Messing - PVD Gold 	354-991-100-367	1AJ01WNJ012446XJA
		Ultra Mattnickel - PVD Satin inox 	354-991-100-066	1AJ01WNJ012498XJA

JO1 WI JO3



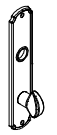

	Bezeichnung - Description	Farbe - Finishes	Alte Art.-Nr. - Old code	1 Stück - Piece
	WC Schild 50x228 mm mit Schlitzschraube 8mm VK WC emergency release only on plate mm 50x228 (8mm WC spindle)	Messing Poliert - Polished varnished	959-991-200-001	1AJ01WIJ032402XJA
		Chrom - Polished chrome	959-991-200-000	1AJ01WIJ032405XJA
		Ultra Messing - PVD Gold 	959-991-200-367	1AJ01WIJ032446XJA
		Antik Nickel - Antique Nickel	959-991-200-444	1AJ01WIJ03248B XJA
		Ultra Mattnickel - PVD Satin inox 	959-991-200-066	1AJ01WIJ032498XJA
	WC Schild 50x228 mm mit Riegel WC turn only on plate mm 50x228	Messing Poliert - Polished varnished	959-991-100-001	1AJ01WNJ032402XJA
		Chrom - Polished chrome	959-991-100-000	1AJ01WNJ032405XJA
		Ultra Messing - PVD Gold 	959-991-100-367	1AJ01WNJ032446XJA
		Antik Nickel - Antique Nickel	959-991-100-444	1AJ01WNJ03248B XJA
		Ultra Mattnickel - PVD Satin inox 	959-991-100-066	1AJ01WNJ032498XJA

	Bezeichnung - Description	Farbe - Finishes	Alte Art.-Nr. - Old code	1 Stück - Piece
	WC Schild 51x227 mm mit Schlitzschraube 8mm VK WC emergency release only on plate mm 51x227 (8mm WC spindle)	Chrom - Polished chrome	983-991-200-000	1AJ01WIJ122405XJA
		Ultra Messing - PVD Gold 	983-991-200-367	1AJ01WIJ122446XJA
		Antik Nickel - Antique Nickel	983-991-200-444	1AJ01WIJ12248BXJA
	WC Schild 51x227 mm mit Riegel WC turn only on plate mm 51x227	Chrom - Polished chrome	983-991-100-000	1AJ01WNJ122405XJA
		Ultra Messing - PVD Gold 	983-991-100-367	1AJ01WNJ122446XJA
		Antik Nickel - Antique Nickel	983-991-100-444	1AJ01WNJ12248BXJA

JO1 WI J14

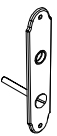

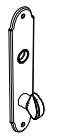

	Bezeichnung - Description	Farbe - Finishes	Alte Art.-Nr. - Old code	1 Stück - Piece
	WC Schild 44x213 mm mit Schlitzschraube 8mm VK WC emergency release only on plate mm 44x213 (8mm WC spindle)	Chrom - Polished chrome	951-991-200-000	1AJ01WIJ142405XJA
		Messing Rustik - Rustic brass	951-991-200-01M	1AJ01WIJ14241MXJA
		Ultra Messing - PVD Gold 	951-991-200-367	1AJ01WIJ142446XJA
	WC Schild 44x213 mm mit Riegel WC turn only on plate mm 44x213	Chrom - Polished chrome	951-991-100-000	1AJ01WNJ142405XJA
		Messing Rustik - Rustic brass	951-991-100-01M	1AJ01WNJ14241MXJA
		Ultra Messing - PVD Gold 	951-991-100-367	1AJ01WNJ142446XJA









JO1 WI J16

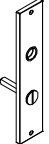





	Bezeichnung - Description	Farbe - Finishes	Alte Art.-Nr. - Old code	1 Stück - Piece
	WC Schild 44x220 mm mit Schlitzschraube 8mm VK WC emergency release only on plate mm 44x220 (8mm WC spindle)	Ultra Messing - PVD Gold 	988-991-200-367	1AJ01WIJ162446XJA
	WC Schild 44x220 mm mit Riegel WC turn only on plate mm 44x220	Ultra Messing - PVD Gold 	988-991-100-367	1AJ01WNJ162446XJA

	Bezeichnung - Description	Farbe - Finishes	Alte Art.-Nr. - Old code	1 Stück - Piece
	WC Schild 50x227 mm mit Schlitzschraube 8mm VK WC emergency release only on plate mm 50x227 (8mm WC spindle)	Chrom - Polished chrome	990-991-200-000	1AJ01WIJ182405XJA
		Messing Rustik - Rustic brass	990-991-200-01M	1AJ01WIJ18241MXJA
		Ultra Messing - PVD Gold 	990-991-200-367	1AJ01WIJ182446XJA
	WC Schild 50x227 mm mit Riegel WC turn only on plate mm 50x227	Chrom - Polished chrome	990-991-100-000	1AJ01WNJ182405XJA
		Messing Rustik - Rustic brass	990-991-100-01M	1AJ01WNJ18241MXJA
		Ultra Messing - PVD Gold 	990-991-100-367	1AJ01WNJ182446XJA



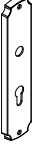





JO1 WI J35



	Bezeichnung - Description	Farbe - Finishes	Alte Art.-Nr. - Old code	1 Stück - Piece
	WC Schild 46x230 mm mit Schlitzschraube 8mm VK WC emergency release only on plate mm 46x230 (8mm WC spindle)	Chrom - Polished chrome	356-991-200-000	1AJ01WIJ352405XJA
		Ultra Mattnickel - PVD Satin inox 	356-991-200-066	1AJ01WIJ352498XJA
	WC Schild 46x230 mm mit Riegel WC turn only on plate mm 46x230	Chrom - Polished chrome	356-991-100-000	1AJ01WNJ352405XJA
		Ultra Mattnickel - PVD Satin inox 	356-991-100-066	1AJ01WNJ352498XJA

	Bezeichnung - Description	Farbe - Finishes	Alte Art.-Nr. - Old code	1 Stück - Piece
	WC Schild 48x236 mm mit Schlitzschraube 8mm VK WC emergency release only on plate mm 48x236 (8mm WC spindle)	Chrom - Polished chrome	964-991-200-000	1AJ01WIJ042405XJA
		Ultra Messing - PVD Gold 	964-991-200-367	1AJ01WIJ042446XJA
		Ultra Mattnickel - PVD Satin inox 	964-991-200-066	1AJ01WIJ042498XJA
		Nickel spiegelpol. Plus - Pol. Nickel Plus 	964-991-200-004	1AJ01WIJ0424K1XJA
	WC Schild 48x236 mm mit Riegel WC turn only on plate mm 48x236	Chrom - Polished chrome	964-455-100-000	1AJ02WNJ042405XJA
		Ultra Messing - PVD Gold 	964-455-100-367	1AJ02WNJ042446XJA
		Ultra Mattnickel - PVD Satin inox 	964-455-100-066	1AJ02WNJ042498XJA
		Nickel spiegelpol. Plus - Pol. Nickel Plus 	964-455-100-004	1AJ02WNJ0424K1XJA



	Bezeichnung - Description	Farbe - Finishes	Alte Art.-Nr. - Old code	1 Stück - Piece
	Schild ohne Loch Plate without key hole	Chrom - Polished chrome	710-000-000-000	1A710KPXXX0105XJA
		Ultra Messing - PVD Gold 	710-000-000-367	1A710KPXXX0146XJA
	Schild 72mm, PZ Plate 72mm Euro Profile cylinder	Chrom - Polished chrome	710-072-200-000	1A710KPXXX1305XJA
		Ultra Messing - PVD Gold 	710-072-200-367	1A710KPXXX1346XJA
	Schild 72 mm BB Plate standard lever key hole 72mm	Chrom - Polished chrome	710-072-100-000	1A710KPXXXB605XJA
		Ultra Messing - PVD Gold 	710-072-100-367	1A710KPXXXB646XJA

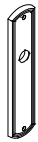





JO1 KP

	Bezeichnung - Description	Farbe - Finishes	Alte Art.-Nr. - Old code	1 Stück - Piece
	Schild ohne Loch Plate without key hole	Chrom - Polished chrome	354-000-000-000	1AJ01KPXXX0105XJA
		Ultra Messing - PVD Gold 	354-000-000-367	1AJ01KPXXX0146XJA
		Ultra Mattnickel - PVD Satin inox 	354-000-000-066	1AJ01KPXXX0198XJA
	Schild 72mm, PZ Plate 72mm Euro Profile cylinder	Chrom - Polished chrome	354-072-200-000	1AJ01KPXXX1305XJA
		Ultra Messing - PVD Gold 	354-072-200-367	1AJ01KPXXX1346XJA
		Ultra Mattnickel - PVD Satin inox 	354-072-200-066	1AJ01KPXXX1398XJA
	Schild 72 mm BB Plate standard lever key hole 72mm	Chrom - Polished chrome	354-072-100-000	1AJ01KPXXXB605XJA
		Ultra Messing - PVD Gold 	354-072-100-367	1AJ01KPXXXB646XJA
		Ultra Mattnickel - PVD Satin inox 	354-072-100-066	1AJ01KPXXXB698XJA







	Bezeichnung - Description	Farbe - Finishes	Alte Art.-Nr. - Old code	1 Stück - Piece
	Schild ohne Loch Plate without key hole	Messing Poliert - Polished varnished	959-000-000-001	1AJ03KPXXX0102XJA
		Chrom - Polished chrome	959-000-000-000	1AJ03KPXXX0105XJA
		Ultra Messing - PVD Gold	959-000-000-367	1AJ03KPXXX0146XJA
		Antik Nickel - Antique Nickel	959-000-000-444	1AJ03KPXXX018BXJA
		Ultra Mattnickel - PVD Satin inox	959-000-000-066	1AJ03KPXXX0198XJA
	Schild 72mm, PZ Plate 72mm Euro Profile cylinder	Messing Poliert - Polished varnished	959-072-200-001	1AJ03KPXXX1302XJA
		Chrom - Polished chrome	959-072-200-000	1AJ03KPXXX1305XJA
		Ultra Messing - PVD Gold	959-072-200-367	1AJ03KPXXX1346XJA
		Antik Nickel - Antique Nickel	959-072-200-444	1AJ03KPXXX138BXJA
		Ultra Mattnickel - PVD Satin inox	959-072-200-066	1AJ03KPXXX1398XJA
	Schild 72 mm BB Plate standard lever key hole 72mm	Messing Poliert - Polished varnished	959-072-100-001	1AJ03KPXXXB602XJA
		Chrom - Polished chrome	959-072-100-000	1AJ03KPXXXB605XJA
		Ultra Messing - PVD Gold	959-072-100-367	1AJ03KPXXXB646XJA
		Antik Nickel - Antique Nickel	959-072-100-444	1AJ03KPXXXB68BXJA
		Ultra Mattnickel - PVD Satin inox	959-072-100-066	1AJ03KPXXXB698XJA
	Schild 92mm, PZ Plate 92mm Euro Profile cylinder	Messing Poliert - Polished varnished	959-192-200-001	1AJ03KP0FP1502XJA
		Chrom - Polished chrome	959-192-200-000	1AJ03KP0FP1505XJA
		Ultra Messing - PVD Gold	959-192-200-367	1AJ03KP0FP1546XJA
		Antik Nickel - Antique Nickel	959-192-200-444	1AJ03KP0FP158BXJA
		Ultra Mattnickel - PVD Satin inox	959-192-200-066	1AJ03KP0FP1598XJA







J12 KP

	Bezeichnung - Description	Farbe - Finishes	Alte Art.-Nr. - Old code	1 Stück - Piece
	Schild ohne Loch Plate without key hole	Chrom - Polished chrome	983-000-000-000	1AJ12KPXXX0105XJA
		Ultra Messing - PVD Gold	983-000-000-367	1AJ12KPXXX0146XJA
		Antik Nickel - Antique Nickel	983-000-000-444	1AJ12KPXXX018BXJA
	Schild 72mm, PZ Plate 72mm Euro Profile cylinder	Chrom - Polished chrome	983-072-200-000	1AJ12KPXXX1305XJA
		Ultra Messing - PVD Gold	983-072-200-367	1AJ12KPXXX1346XJA
		Antik Nickel - Antique Nickel	983-072-200-444	1AJ12KPXXX138BXJA
	Schild 72 mm BB Plate standard lever key hole 72mm	Chrom - Polished chrome	983-072-100-000	1AJ12KPXXXB605XJA
		Ultra Messing - PVD Gold	983-072-100-367	1AJ12KPXXXB646XJA
		Antik Nickel - Antique Nickel	983-072-100-444	1AJ12KPXXXB68BXJA

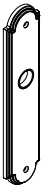
	Bezeichnung - Description	Farbe - Finishes	Alte Art.-Nr. - Old code	1 Stück - Piece
	Schild ohne Loch Plate without key hole	Chrom - Polished chrome	951-000-000-000	1AJ14KPXXX0105XJA
		Messing Rustik - Rustic brass	951-000-000-01M	1AJ14KPXXX011MXJA
		Ultra Messing - PVD Gold 	951-000-000-367	1AJ14KPXXX0146XJA
	Schild 72mm, PZ Plate 72mm Euro Profile cylinder	Chrom - Polished chrome	951-072-200-000	1AJ14KPXXX1305XJA
		Messing Rustik - Rustic brass	951-072-200-01M	1AJ14KPXXX131MXJA
		Ultra Messing - PVD Gold 	951-072-200-367	1AJ14KPXXX1346XJA
	Schild 72 mm BB Plate standard lever key hole 72mm	Chrom - Polished chrome	951-072-100-000	1AJ14KPXXXB605XJA
		Messing Rustik - Rustic brass	951-072-100-01M	1AJ14KPXXXB61MXJA
		Ultra Messing - PVD Gold 	951-072-100-367	1AJ14KPXXXB646XJA

J16 KP

	Bezeichnung - Description	Farbe - Finishes	Alte Art.-Nr. - Old code	1 Stück - Piece
	Schild ohne Loch Plate without key hole	Ultra Messing - PVD Gold 	988-000-000-367	1AJ16KPXXX0146XJA
	Schild 72mm, PZ Plate 72mm Euro Profile cylinder	Ultra Messing - PVD Gold 	988-072-200-367	1AJ16KPXXX1346XJA
	Schild 72 mm BB Plate standard lever key hole 72mm	Ultra Messing - PVD Gold 	988-072-100-367	1AJ16KPXXXB646XJA

	Bezeichnung - Description	Farbe - Finishes	Alte Art.-Nr. - Old code	1 Stück - Piece
	Schild ohne Loch Plate without key hole	Messing Poliert - Polished varnished	990-010-000-001	1AJ18KPXXX0102XJA
		Chrom - Polished chrome	990-010-000-000	1AJ18KPXXX0105XJA
		Ultra Messing - PVD Gold 	990-010-000-367	1AJ18KPXXX0146XJA
	Schild 72mm, PZ Plate 72mm Euro Profile cylinder	Messing Poliert - Polished varnished	990-072-200-001	1AJ18KPXXX1302XJA
		Chrom - Polished chrome	990-072-200-000	1AJ18KPXXX1305XJA
		Ultra Messing - PVD Gold 	990-072-200-367	1AJ18KPXXX1346XJA
	Schild 72 mm BB Plate standard lever key hole 72mm	Messing Poliert - Polished varnished	990-072-100-001	1AJ18KPXXXB602XJA
		Chrom - Polished chrome	990-072-100-000	1AJ18KPXXXB605XJA
		Ultra Messing - PVD Gold 	990-072-100-367	1AJ18KPXXXB646XJA

	Bezeichnung - Description	Farbe - Finishes	Alte Art.-Nr. - Old code	1 Stück - Piece
	Schild ohne Loch Plate without key hole	Chrom - Polished chrome	356-000-000-000	1AJ35KPXXX0105XJA
		Ultra Mattnickel - PVD Satin inox 	356-000-000-066	1AJ35KPXXX0198XJA
	Schild 72mm, PZ Plate 72mm Euro Profile cylinder	Chrom - Polished chrome	356-072-200-000	1AJ35KPXXX1305XJA
		Ultra Mattnickel - PVD Satin inox 	356-072-200-066	1AJ35KPXXX1398XJA
	Schild 72 mm BB Plate standard lever key hole 72mm	Chrom - Polished chrome	356-072-100-000	1AJ35KPXXXB605XJA
		Ultra Mattnickel - PVD Satin inox 	356-072-100-066	1AJ35KPXXXB698XJA

JO4 KP

	Bezeichnung - Description	Farbe - Finishes	Alte Art.-Nr. - Old code	1 Stück - Piece
	Schild ohne Loch Plate without key hole	Chrom - Polished chrome	964-000-000-000	1AJ04KPXXX0105XJA
		Schwarz RAL 9005 - Matt black RAL 9005	964-000-000-180	1AJ04KPXXX0118XJA
		Ultra Messing - PVD Gold 	964-000-000-367	1AJ04KPXXX0146XJA
		Ultra Mattnickel - PVD Satin inox 	964-000-000-066	1AJ04KPXXX0198XJA
		Nickel spiegelpol. Plus - Pol. Nickel Plus 	964-000-000-004	1AJ04KPXXX01K1XJA
	Schild 72mm, PZ Plate 72mm Euro Profile cylinder	Chrom - Polished chrome	964-072-200-000	1AJ04KPXXX1305XJA
		Schwarz RAL 9005 - Matt black RAL 9005	964-072-200-180	1AJ04KPXXX1318XJA
		Ultra Messing - PVD Gold 	964-072-200-367	1AJ04KPXXX1346XJA
		Ultra Mattnickel - PVD Satin inox 	964-072-200-066	1AJ04KPXXX1398XJA
		Nickel spiegelpol. Plus - Pol. Nickel Plus 	964-072-200-004	1AJ04KPXXX13K1XJA
	Schild 92mm, PZ Plate 92mm Euro Profile cylinder	Chrom - Polished chrome	964-192-200-000	1AJ04KP0FP1505XJA
		Schwarz RAL 9005 - Matt black RAL 9005	964-192-200-180	1AJ04KP0FP1518XJA
		Ultra Messing - PVD Gold 	964-192-200-367	1AJ04KP0FP1546XJA
		Ultra Mattnickel - PVD Satin inox 	964-192-200-066	1AJ04KP0FP1598XJA
		Nickel spiegelpol. Plus - Pol. Nickel Plus 	964-192-200-004	1AJ04KP0FP15K1XJA
	Schild 72 mm BB Plate standard lever key hole 72mm	Chrom - Polished chrome	964-072-100-000	1AJ04KPXXXB605XJA
		Schwarz RAL 9005 - Matt black RAL 9005	964-072-100-180	1AJ04KPXXXB618XJA
		Ultra Messing - PVD Gold 	964-072-100-367	1AJ04KPXXXB646XJA
		Ultra Mattnickel - PVD Satin inox 	964-072-100-066	1AJ04KPXXXB698XJA
		Nickel spiegelpol. Plus - Pol. Nickel Plus 	964-072-100-004	1AJ04KPXXXB6K1XJA

	Bezeichnung - Description	Farbe - Finishes	Alte Art.-Nr. - Old code	1 Stück - Piece
	Gewindestift M 6 x 7mm mit Spitze und Sicherungslack, für Vollvierkantstifte mit Kerbe (10-stückweise verpackt) <i>Setscrew M 6 x 7 mm with flat point and protective lacquer, for solid spindles with groove (10 per box)</i>	Vernickelt - Nickel Plated	000-141-000-999	1A482CDJ00XX3DXXX
	Gewindestift M 6 x 7mm mit Spitze und Sicherungslack, für Vollvierkantstifte mit Kerbe (10-stückweise verpackt) <i>Setscrew M 6 x 7 mm with flat point and protective lacquer, for solid spindles with groove (10 per box)</i>	Vernickelt - Nickel Plated	000-141-000-999	1A482CDJ00XX3DXXX

	Bezeichnung - Description	Farbe - Finishes	Alte Art.-Nr. - Old code	1 Stück - Piece
	Bohrschablone <i>Drilling template</i>	Schwarzer Kunststoff - Black Plastic	000-031-000-999	1A371CDJ00XX4CXXX
	Fixierstift zu Bohrschablone 7mm <i>Dowel pin for drilling template 7mm</i>	Schwarzer Kunststoff - Black Plastic	000-296-000-999	1A401CDJ00XX4CXXX
	Fixierstift zu Bohrschablone 8mm <i>Dowel pin for drilling template 8mm</i>	Schwarzer Kunststoff - Black Plastic	000-297-000-999	1A402CDJ00XX4CXXX
	Fixierstift zu Bohrschablone 9mm <i>Dowel pin for drilling template 9mm</i>	Schwarzer Kunststoff - Black Plastic	000-298-000-999	1A403CDJ00XX4CXXX
	Fixierstift zu Bohrschablone 10mm <i>Dowel pin for drilling template 10mm</i>	Schwarzer Kunststoff - Black Plastic	000-299-000-999	1A404CDJ00XX4CXXX

	Bezeichnung - Description	Farbe - Finishes	Alte Art.-Nr. - Old code	1 Stück - Piece
	Hochhaltefeder Returning spring	Schwarzer Kunststoff - Black Plastic	000-142-000-999	1AJ01MLXXXXX4CXXX
	Hochhaltefeder mit 2xM5 Gewindenocken Returning spring with 2xM5 threads	Schwarzer Kunststoff - Black Plastic	000-141-A00-999	1AJ01MLXXX454CXXX

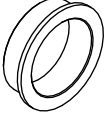
	Bezeichnung - Description	Farbe - Finishes	Alte Art.-Nr. - Old code	1 Stück - Piece
	Drückerführungsring 18mm außen 19,5mm Nylon washer 18mm with head (hole reduction from 19,5)	Schwarzer Kunststoff - Black Plastic	018-195-064-999	1A018GR195644BXXX

Bezeichnung - Description	Farbe - Finishes	Alte Art.-Nr. - Old code	1 Stück - Piece
Rastergehäuse für abschließbare und nicht abschließbare Oliven 7x30 vorstehend / 8x45 VK mit 2 Schrauben M5x40 <i>D.K. mechanism with 7x30 external / 8x45 internal spindle with 2 screws M5x40</i>	Vernickelt - Nickel Plated	000-800-030-999	1AJ01CDXXXXX3DXXX
Rastergehäuse für abschließbare und nicht abschließbare Oliven 7x35 vorstehend / 8x45 VK mit 2 Schrauben M5x45 <i>D.K. mechanism with 7x35 external / 8x45 internal spindle with 2 screws M5x45</i>	Vernickelt - Nickel Plated	000-800-035-999	1AJ02CDXXXXX3DXXX
Rastergehäuse für abschließbare und nicht abschließbare Oliven 7x40 vorstehend / 8x45 VK mit 2 Schrauben M5x50 <i>D.K. mechanism with 7x40 external / 8x45 internal spindle with 2 screws M5x50</i>	Vernickelt - Nickel Plated	000-800-040-999	1AJ03CDXXXXX3DXXX
Rastergehäuse für abschließbare und nicht abschließbare Oliven 7x45 vorstehend / 8x45 VK mit 2 Schrauben M5x55 <i>D.K. mechanism with 7x45 external / 8x45 internal spindle with 2 screws M5x55</i>	Vernickelt - Nickel Plated	000-800-045-999	1AJ04CDXXXXX3DXXX
Rastergehäuse für abschließbare und nicht abschließbare Oliven 7x50 vorstehend / 8x45 VK mit 2 Schrauben M5x60 <i>D.K. mechanism with 7x50 external / 8x45 internal spindle with 2 screws M5x60</i>	Vernickelt - Nickel Plated	000-800-050-999	1AJ05CDXXXXX3DXXX
Rastergehäuse für abschließbare und nicht abschließbare Oliven 7x55 vorstehend / 8x45 VK mit 2 Schrauben M5x65 <i>D.K. mechanism with 7x55 external / 8x45 internal spindle with 2 screws M5x65</i>	Vernickelt - Nickel Plated	000-800-055-999	1AJ06CDXXXXX3DXXX
Rastergehäuse für abschließbare und nicht abschließbare Oliven 7x60 vorstehend / 8x45 VK mit 2 Schrauben M5x70 <i>D.K. mechanism with 7x60 external / 8x45 internal spindle with 2 screws M5x70</i>	Vernickelt - Nickel Plated	000-800-060-999	1AJ07CDXXXXX3DXXX
Rastergehäuse für abschließbare und nicht abschließbare Oliven 7x65 vorstehend / 8x45 VK mit 2 Schrauben M5x75 <i>D.K. mechanism with 7x65 external / 8x45 internal spindle with 2 screws M5x75</i>	Vernickelt - Nickel Plated	000-800-065-999	1AJ08CDXXXXX3DXXX
Rastergehäuse für abschließbare und nicht abschließbare Oliven 7x70 vorstehend / 8x45 VK mit 2 Schrauben M5x80 <i>D.K. mechanism with 7x70 external / 8x45 internal spindle with 2 screws M5x80</i>	Vernickelt - Nickel Plated	000-800-070-999	1AJ09CDXXXXX3DXXX
Rastergehäuse für abschließbare und nicht abschließbare Oliven 7x75 vorstehend / 8x45 VK mit 2 Schrauben M5x85 <i>D.K. mechanism with 7x75 external / 8x45 internal spindle with 2 screws M5x85</i>	Vernickelt - Nickel Plated	000-800-075-999	1AJ10CDXXXXX3DXXX
Rastergehäuse für abschließbare und nicht abschließbare Oliven 7x80 vorstehend / 8x45 VK mit 2 Schrauben M5x90 <i>D.K. mechanism with 7x80 external / 8x45 internal spindle with 2 screws M5x90</i>	Vernickelt - Nickel Plated	000-800-080-999	1AJ11CDXXXXX3DXXX
Rastergehäuse für abschließbare und nicht abschließbare Oliven 7x85 vorstehend / 8x45 VK mit 2 Schrauben M5x95 <i>D.K. mechanism with 7x85 external / 8x45 internal spindle with 2 screws M5x95</i>	Vernickelt - Nickel Plated	000-800-085-999	1AJ12CDXXXXX3DXXX



Bezeichnung - Description	Farbe - Finishes	Alte Art.-Nr. - Old code	1 Stück - Piece
Rastergehäuse RC2 zertifiziert (abschließbar) mit 7x30 vorstehend / 8x45 VK mit 2 Schrauben M5x40 <i>D.K. mechanism RC2 Certified with 7x30 external / 8x45 internal spindle with 2 screws M5x40</i>	Vernickelt - Nickel Plated	AJ5-1CD-***-**3	1AJ51CDXXXXX3DXXX
Rastergehäuse RC2 zertifiziert (abschließbar) mit 7x35 vorstehend / 8x45 VK mit 2 Schrauben M5x40 <i>D.K. mechanism RC2 Certified with 7x35 external / 8x45 internal spindle with 2 screws M5x40</i>	Vernickelt - Nickel Plated	AJ5-2CD-***-**3	1AJ52CDXXXXX3DXXX
Rastergehäuse RC2 zertifiziert (abschließbar) mit 7x40 vorstehend / 8x45 VK mit 2 Schrauben M5x40 <i>D.K. mechanism RC2 Certified with 7x40 external / 8x45 internal spindle with 2 screws M5x40</i>	Vernickelt - Nickel Plated	J53-CD*-***-**3D	1AJ53CDXXXXX3DXXX
Rastergehäuse RC2 zertifiziert (abschließbar) mit 7x45 vorstehend / 8x45 VK mit 2 Schrauben M5x40 <i>D.K. mechanism RC2 Certified with 7x45 external / 8x45 internal spindle with 2 screws M5x40</i>	Vernickelt - Nickel Plated	AJ5-4CD-***-**3	1AJ54CDXXXXX3DXXX
Rastergehäuse RC2 zertifiziert (abschließbar) mit 7x50 vorstehend / 8x45 VK mit 2 Schrauben M5x40 <i>D.K. mechanism RC2 Certified with 7x50 external / 8x45 internal spindle with 2 screws M5x40</i>	Vernickelt - Nickel Plated	AJ5-5CD-***-**3	1AJ55CDXXXXX3DXXX
Rastergehäuse RC2 zertifiziert (abschließbar) mit 7x55 vorstehend / 8x45 VK mit 2 Schrauben M5x40 <i>D.K. mechanism RC2 Certified with 7x55 external / 8x45 internal spindle with 2 screws M5x40</i>	Vernickelt - Nickel Plated	AJ5-6CD-***-**3	1AJ56CDXXXXX3DXXX
Rastergehäuse RC2 zertifiziert (abschließbar) mit 7x60 vorstehend / 8x45 VK mit 2 Schrauben M5x40 <i>D.K. mechanism RC2 Certified with 7x60 external / 8x45 internal spindle with 2 screws M5x40</i>	Vernickelt - Nickel Plated	AJ5-7CD-***-**3	1AJ57CDXXXXX3DXXX
Rastergehäuse RC2 zertifiziert (abschließbar) mit 7x65 vorstehend / 8x45 VK mit 2 Schrauben M5x40 <i>D.K. mechanism RC2 Certified with 7x65 external / 8x45 internal spindle with 2 screws M5x40</i>	Vernickelt - Nickel Plated	AJ5-8CD-***-**3	1AJ58CDXXXXX3DXXX
Rastergehäuse RC2 zertifiziert (abschließbar) mit 7x70 vorstehend / 8x45 VK mit 2 Schrauben M5x40 <i>D.K. mechanism RC2 Certified with 7x70 external / 8x45 internal spindle with 2 screws M5x40</i>	Vernickelt - Nickel Plated	AJ5-9CD-***-**3	1AJ59CDXXXXX3DXXX





Bezeichnung - Description	Farbe - Finishes	Alte Art.-Nr. - Old code	1 Stück - Piece
Rastergehäuse System TBT (abschließbar) mit 7x30 vorstehend / 8x45 VK mit 2 Schrauben M5x40 <i>D.K. mechanism TBT System with 7x30 external / 8x45 internal spindle with 2 screws M5x40</i>	Vernickelt - Nickel Plated	AJ7-1CD-***-**3	1AJ71CDXXXXX3DXXX
Rastergehäuse System TBT (abschließbar) mit 7x35 vorstehend / 8x45 VK mit 2 Schrauben M5x40 <i>D.K. mechanism TBT System with 7x35 external / 8x45 internal spindle with 2 screws M5x40</i>	Vernickelt - Nickel Plated	AJ7-2CD-***-**3	1AJ72CDXXXXX3DXXX
Rastergehäuse System TBT (abschließbar) mit 7x40 vorstehend / 8x45 VK mit 2 Schrauben M5x40 <i>D.K. mechanism TBT System with 7x40 external / 8x45 internal spindle with 2 screws M5x40</i>	Vernickelt - Nickel Plated	AJ7-3CD-***-**3	1AJ73CDXXXXX3DXXX
Rastergehäuse System TBT (abschließbar) mit 7x45 vorstehend / 8x45 VK mit 2 Schrauben M5x40 <i>D.K. mechanism TBT System with 7x45 external / 8x45 internal spindle with 2 screws M5x40</i>	Vernickelt - Nickel Plated	AJ7-4CD-***-**3	1AJ74CDXXXXX3DXXX
Rastergehäuse System TBT (abschließbar) mit 7x50 vorstehend / 8x45 VK mit 2 Schrauben M5x40 <i>D.K. mechanism TBT System with 7x50 external / 8x45 internal spindle with 2 screws M5x40</i>	Vernickelt - Nickel Plated	AJ7-5CD-***-**3	1AJ75CDXXXXX3DXXX
Rastergehäuse System TBT (abschließbar) mit 7x55 vorstehend / 8x45 VK mit 2 Schrauben M5x40 <i>D.K. mechanism TBT System with 7x55 external / 8x45 internal spindle with 2 screws M5x40</i>	Vernickelt - Nickel Plated	AJ7-6CD-***-**3	1AJ76CDXXXXX3DXXX
Rastergehäuse System TBT (abschließbar) mit 7x60 vorstehend / 8x45 VK mit 2 Schrauben M5x40 <i>D.K. mechanism TBT System with 7x60 external / 8x45 internal spindle with 2 screws M5x40</i>	Vernickelt - Nickel Plated	AJ7-7CD-***-**3	1AJ77CDXXXXX3DXXX
Rastergehäuse System TBT (abschließbar) mit 7x65 vorstehend / 8x45 VK mit 2 Schrauben M5x40 <i>D.K. mechanism TBT System with 7x65 external / 8x45 internal spindle with 2 screws M5x40</i>	Vernickelt - Nickel Plated	AJ7-8CD-***-**3	1AJ78CDXXXXX3DXXX
Rastergehäuse System TBT (abschließbar) mit 7x70 vorstehend / 8x45 VK mit 2 Schrauben M5x40 <i>D.K. mechanism TBT System with 7x70 external / 8x45 internal spindle with 2 screws M5x40</i>	Vernickelt - Nickel Plated	AJ7-9CD-***-**3	1AJ79CDXXXXX3DXXX
Rastergehäuse System TBT (abschließbar) mit 7x75 vorstehend / 8x45 VK mit 2 Schrauben M5x40 <i>D.K. mechanism TBT System with 7x75 external / 8x45 internal spindle with 2 screws M5x40</i>	Vernickelt - Nickel Plated	AJ8-0CD-***-**3	1AJ80CDXXXXX3DXXX
Rastergehäuse System TBT (abschließbar) mit 7x80 vorstehend / 8x45 VK mit 2 Schrauben M5x40 <i>D.K. mechanism TBT System with 7x80 external / 8x45 internal spindle with 2 screws M5x40</i>	Vernickelt - Nickel Plated	AJ8-1CD-***-**3	1AJ81CDXXXXX3DXXX
Rastergehäuse System TBT (abschließbar) mit 7x85 vorstehend / 8x45 VK mit 2 Schrauben M5x40 <i>D.K. mechanism TBT System with 7x85 external / 8x45 internal spindle with 2 screws M5x40</i>	Vernickelt - Nickel Plated	AJ8-2CD-***-**3	1AJ82CDXXXXX3DXXX



Bezeichnung - Description	Farbe - Finishes	Alte Art.-Nr. - Old code	1 Stück - Piece
Drückerstift 10 auf 8 mm abgesetzt 95 mm lang für Türstärke 37-52 mm <i>Lever spindles 10 / 8 mm chamfered 95 mm long for door thickness 37-52 mm</i>	Vernickelt - Nickel Plated	000-090-A00-999	1A433CDJ00XX3DXXX
Drückerstift 10 auf 8 mm abgesetzt 120 mm lang für Türstärke 61-76 mm <i>Lever spindles 10 / 8 mm chamfered 120 mm long for door thickness 61-76 mm</i>	Vernickelt - Nickel Plated	000-097-A00-999	1A434CDJ00XX3DXXX
Drückerstift 10 auf 8 mm abgesetzt 160 mm lang für Türstärke 102 - 111 mm <i>Spindle 10/8 x 160 mm for door thickness 102-111 mm</i>	Vernickelt - Nickel Plated	000-093-A00-999	1A524CDJ00XX3DXXX
Drückerstift 10 auf 8 mm abgesetzt 170 mm lang für Türstärke 112 - 121 mm <i>Spindle 10/8 x 170 mm for door thickness 112-121 mm</i>	Vernickelt - Nickel Plated	000-094-A00-999	1A525CDJ00XX3DXXX



Bezeichnung - Description	Farbe - Finishes	Alte Art.-Nr. - Old code	1 Stück - Piece
Wechselstift 8 x 58 mm für Türstärke 33-42 mm <i>Short spindle 8 x 58 mm for door thickness 33-42 mm</i>	Vernickelt - Nickel Plated	000-256-A00-999	1A435CDJ00XX3DXXX
Wechselstift 8 x 68 mm für Türstärke 43-52 mm <i>Short spindle 8 x 68 mm for door thickness 43-52 mm</i>	Vernickelt - Nickel Plated	000-257-A00-999	1A436CDJ00XX3DXXX
Wechselstift 8 x 78 mm für Türstärke 53-62 mm <i>Short spindle 8 x 78 mm for door thickness 53-62 mm</i>	Vernickelt - Nickel Plated	000-258-A00-999	1A437CDJ00XX3DXXX
Wechselstift 8 x 88 mm für Türstärke 63-72 mm <i>Short spindle 8 x 88 mm for door thickness 63-72 mm</i>	Vernickelt - Nickel Plated	000-259-A00-999	1A438CDJ00XX3DXXX
Wechselstift 8 x 98 mm für Türstärke 73-82 mm <i>Short spindle 8 x 98 mm for door thickness 73-82 mm</i>	Vernickelt - Nickel Plated	000-260-A00-999	1A439CDJ00XX3DXXX
Wechselstift 8 x 108 mm für Türstärke 78 - 87 mm <i>Short spindle 8 x 108 mm for door thickness 78 - 87 mm</i>	Vernickelt - Nickel Plated	000-261-A00-999	1A440CDJ00XX3DXXX
Wechselstift 8 x 118 mm für Türstärke 88 - 97 mm <i>Short spindle 8 x 118 mm for door thickness 88 - 97 mm</i>	Vernickelt - Nickel Plated	000-269-A00-999	1A526CDJ00XX3DXXX
Wechselstift 8 x 128 mm für Türstärke 98 - 107 mm <i>Short spindle 8 x 128 mm for door thickness 98 - 107 mm</i>	Vernickelt - Nickel Plated	000-270-A00-999	1A527CDJ00XX3DXXX
Wechselstift 8 x 138 mm für Türstärke 108 - 117 mm <i>Short spindle 8 x 138 mm for door thickness 108 - 117 mm</i>	Vernickelt - Nickel Plated	000-271-A00-999	1A528CDJ00XX3DXXX

Bezeichnung - Description	Farbe - Finishes	Alte Art.-Nr. - Old code	1 Stück - Piece
Wechselstift 10/8 x 58 mm für Türstärke 33-42 mm <i>Short spindle 10/8 x 58 mm for door thickness 33-42 mm</i>	Vernickelt - Nickel Plated	000-262-A00-999	1A441CDJ00XX3DXXX
Wechselstift 10/8 x 68 mm für Türstärke 43-52 mm <i>Short spindle 10/8 x 68 mm for door thickness 43-52 mm</i>	Vernickelt - Nickel Plated	000-263-A00-999	1A442CDJ00XX3DXXX
Wechselstift 10/8 x 78 mm für Türstärke 53-62 mm <i>Short spindle 10/8 x 78 mm for door thickness 53-62 mm</i>	Vernickelt - Nickel Plated	000-264-A00-999	1A443CDJ00XX3DXXX
Wechselstift 10/8 x 88 mm für Türstärke 63-72 mm <i>Short spindle 10/8 x 88 mm for door thickness 63-72 mm</i>	Vernickelt - Nickel Plated	000-265-A00-999	1A444CDJ00XX3DXXX
 Wechselstift 10/8 x 98 mm für Türstärke 73-82 mm <i>Short spindle 10/8 x 98 mm for door thickness 73-82 mm</i>	Vernickelt - Nickel Plated	000-266-A00-999	1A445CDJ00XX3DXXX
Wechselstift 10/8 x 108 mm für Türstärke 83-92 mm <i>Short spindle 10/8 x 108 mm for door thickness 83-92 mm</i>	Vernickelt - Nickel Plated	000-267-A00-999	1A446CDJ00XX3DXXX
Wechselstift 10/8 x 118 mm für Türstärke 93-102 mm <i>Short spindle 10/8 x 118 mm for door thickness 93-102 mm</i>	Vernickelt - Nickel Plated	000-268-A00-999	1A447CDJ00XX3DXXX
Wechselstift 10/8 x 128 mm für Türstärke 98 - 107 mm <i>Short spindle 10/8 x 128 mm for door thickness 98 - 107 mm</i>	Vernickelt - Nickel Plated	000-274-A00-999	1A530CDJ00XX3DXXX
Wechselstift 10/8 x 138 mm für Türstärke 108 - 117 mm <i>Short spindle 10/8 x 138 mm for door thickness 108 - 117 mm</i>	Vernickelt - Nickel Plated	000-275-A00-999	1A531CDJ00XX3DXXX
Wechselstift 10/8 x 148 mm für Türstärke 118 - 122 mm <i>Short spindle 10/8 x 148 mm for door thickness 118 - 122 mm</i>	Vernickelt - Nickel Plated	000-276-A00-999	1A532CDJ00XX3DXXX

Bezeichnung - Description	Farbe - Finishes	Alte Art.-Nr. - Old code	1 Stück - Piece
 Wechselstift für einseitig gebohrte Tür, 10 auf 8 mm, Länge 62 mm, für Türstärke = Maß X 18-24 mm <i>Short spindle for semi-drilled door, 10 x 8 mm, length 62 mm, for door thickness = measurement X 18-24 mm</i>	Vernickelt - Nickel Plated	000-108-A00-999	1A463CDJ00XX3DXXX
Wechselstift für einseitig gebohrte Tür, 10 auf 8 mm, Länge 92 mm, für Türstärke = Maß X 48-54 mm <i>Short spindle for semi-drilled door, 10 x 8 mm, length 92 mm, for door thickness = measurement X 48-54 mm</i>	Vernickelt - Nickel Plated	000-109-A00-999	1A464CDJ00XX3DXXX

Bezeichnung - Description	Farbe - Finishes	Alte Art.-Nr. - Old code	1 Stück - Piece
 Wechselstift für einseitig gebohrte Tür, 8 mm, Länge 62 mm, für Türstärke = Maß X 18-24 mm <i>Short spindle for semi-drilled door, 8 mm, length 62 mm, for door thickness = measurement X 18-24 mm</i>	Vernickelt - Nickel Plated	000-006-A00-999	1A467CDJ00XX3DXXX
Wechselstift für einseitig gebohrte Tür, 8 mm, Länge 92 mm, für Türstärke = Maß X 48-54 mm <i>Short spindle for semi-drilled door, 8 mm, length 92 mm, for door thickness = measurement X 48-54 mm</i>	Vernickelt - Nickel Plated	000-007-A00-999	1A468CDJ00XX3DXXX

	Bezeichnung - Description	Farbe - Finishes	Alte Art.-Nr. - Old code	1 Stück - Piece
	Vollvierkantstift 7 x 52 mm für Fensteroliven <i>Solid spindle 7 x 52 mm for window handles</i>	Vernickelt - Nickel Plated	000-110-000-999	1A382CDJ00XX3DXXX
	Vollvierkantstift 8 x 52 mm für WC-Verriegelung <i>Solid spindle 8 x 52 mm for Toilet door thumbturn</i>	Vernickelt - Nickel Plated	000-113-000-999	1A383CDJ00XX3DXXX

	Bezeichnung - Description	Farbe - Finishes	Alte Art.-Nr. - Old code	1 Stück - Piece
	Drückerstift 8 x 95 mm für Türstärke 38-45 mm <i>Lever spindles 8 x 95 mm for door thickness 38-45 mm</i>	Vernickelt - Nickel Plated	000-088-A00-999	1A475CDJ00XX3DXXX
	Drückerstift 8 x 100 mm <i>Lever spindles 8 x 100 mm</i>	Vernickelt - Nickel Plated	000-086-A00-999	1A427CDJ00XX3DXXX
	Drückerstift 8 x 105 mm für Türstärke 46-55 mm <i>Lever spindles 8 x 105 mm for door thickness 46-55 mm</i>	Vernickelt - Nickel Plated	000-095-A00-999	1A483CDJ00XX3DXXX
	Drückerstift 8 x 115 mm für Türstärke 56-60 mm <i>Lever spindles 8 x 115 mm for door thickness 56-60 mm</i>	Vernickelt - Nickel Plated	000-081-A00-999	1A485CDJ00XX3DXXX
	Drückerstift 8 x 120 mm für Türstärke 61-70 mm <i>Lever spindles 8 x 120 mm for door thickness 61-70 mm</i>	Vernickelt - Nickel Plated	000-096-A00-999	1A431CDJ00XX3DXXX
	Drückerstift 8 x 130 mm für Türstärke 71-80 mm <i>Lever spindles 8 x 130 mm for door thickness 71-80 mm</i>	Vernickelt - Nickel Plated	000-105-A00-999	1A494CDJ00XX3DXXX
	Drückerstift 8 x 150 für Türstärke 91-100 mm <i>Lever spindles 8 x 150 mm for door thickness 91-100 mm</i>	Vernickelt - Nickel Plated	000-100-A00-999	1A432CDJ00XX3DXXX

	Bezeichnung - Description	Farbe - Finishes	Alte Art.-Nr. - Old code	1 Stück - Piece
	Verstärkerhülse 8 x 8,5 mm <i>Reinforcing sleeve 8 x 8,5 mm</i>	Vernickelt - Nickel Plated	000-077-000-999	1A032CDJ00XX3DXXX
	Verstärkerhülse 8 x 9 mm <i>Reinforcing sleeve 8 x 9 mm</i>	Vernickelt - Nickel Plated	000-078-000-999	1A033CDJ00XX3DXXX
	Verstärkerhülse 8 x 10 mm <i>Reinforcing sleeve 8 x 10 mm</i>	Vernickelt - Nickel Plated	000-082-000-999	1A035CDJ00XX3AXXX
	Reduzierhülse 8 x 6 mm <i>Reducing sleeve 8 x 6 mm</i>	Vernickelt - Nickel Plated	000-070-000-999	1A374CDJ00XX3DXXX
	Reduzierhülse 8 x 7 mm <i>Reducing sleeve 8 x 7 mm</i>	Vernickelt - Nickel Plated	000-072-000-999	1A375CDJ00XX3DXXX

Bezeichnung - Description	Farbe - Finishes	Alte Art.-Nr. - Old code	1 Stück - Piece
Wechselstift 9 x 64 mm <i>Short spindle 9 x 64 mm and screw M6x6</i>	Vernickelt - Nickel Plated	000-783-000-999	1A227CDJ00XX3DXXX
Wechselstift 9 x 72 mm <i>Short spindle 9 x 72 mm and screw M6x6</i>	Vernickelt - Nickel Plated	000-784-000-999	1A228CDJ00XX3DXXX
Wechselstift 9 x 90 mm mit Schraube M6x6 <i>Short spindle 9 x 90mm with screw M6x6</i>	Vernickelt - Nickel Plated	000-786-000-999	1A511CDJ00XX3DXXX
Wechselstift 9 x 100 mm mit Schraube M6x6 <i>Short spindle 9 x 100mm with screw M6x6</i>	Vernickelt - Nickel Plated	000-787-000-999	1A512CDJ00XX3DXXX
Wechselstift 9 x 110 mm mit Schraube M6x6 <i>Short spindle 9 x 110mm with screw M6x6</i>	Vernickelt - Nickel Plated	000-788-000-999	1A513CDJ00XX3DXXX
Wechselstift 9 x 120 mm mit Schraube M6x6 <i>Short spindle 9 x 120mm with screw M6x6</i>	Vernickelt - Nickel Plated	000-789-000-999	1A514CDJ00XX3DXXX
Wechselstift 9 x 130 mm mit Schraube M6x6 <i>Short spindle 9 x 130mm with screw M6x6</i>	Vernickelt - Nickel Plated	000-791-000-999	1A515CDJ00XX3DXXX
Wechselstift 9 x 140 mm mit Schraube M6x6 <i>Short spindle 9 x 140mm with screw M6x6</i>	Vernickelt - Nickel Plated	000-792-000-999	1A516CDJ00XX3DXXX



Bezeichnung - Description	Farbe - Finishes	Alte Art.-Nr. - Old code	1 Stück - Piece
Drückerstift 9 x 105 mm für Türstärke 46 - 55 mm <i>Lever spindles 9 x 105 mm for door thickness 46 - 55 mm</i>	Vernickelt - Nickel Plated	000-120-000-999	1A496CDJ00XX3DXXX
Drückerstift 9 x 115 mm für Türstärke 56 - 60 mm <i>Lever spindles 9 x 115 mm for door thickness 56 - 60 mm</i>	Vernickelt - Nickel Plated	000-127-000-999	1A497CDJ00XX3DXXX
Drückerstift 9 x 120 mm für Türstärke 61 - 70 mm <i>Lever spindles 9 x 120 mm for door thickness 61 - 70 mm</i>	Vernickelt - Nickel Plated	000-139-000-999	1A498CDJ00XX3DXXX
Drückerstift 9 x 130 mm für Türstärke 71 - 80 mm <i>Lever spindles 9 x 130 mm for door thickness 71 - 80 mm</i>	Vernickelt - Nickel Plated	000-159-000-999	1A499CDJ00XX3DXXX
Drückerstift 9 x 140 mm für Türstärke 81 - 90 mm <i>Lever spindles 9 x 140 mm for door thickness 81 - 90 mm</i>	Vernickelt - Nickel Plated	000-161-000-999	1A500CDJ00XX3DXXX
Drückerstift 9 x 150 mm für Türstärke 91 - 100 mm <i>Lever spindles 9 x 150 mm for door thickness 91 - 100 mm</i>	Vernickelt - Nickel Plated	000-162-000-999	1A501CDJ00XX3DXXX





DIN
18273



FEUERSCHUTZ
FIRE PROOF



 JATEC

FEUERSCHUTZ
FIRE PROOF



952 GF 914

EDELSTAHL - STAINLESS STEEL



PASSENDE TÜRGRIFFE
SUITABLE DOOR HANDLES

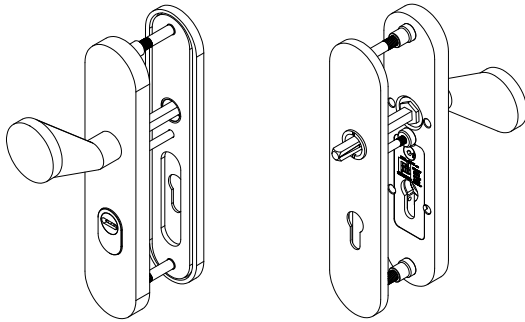

50
Edelstahl Spiegelpoliert
Polished stainless steel

5S
Edelstahl
Stainless steel 304

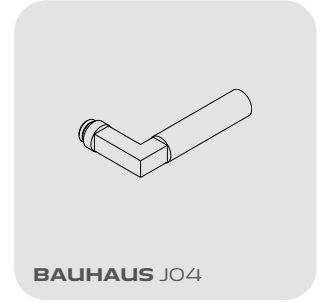

BAUHAUS JO4

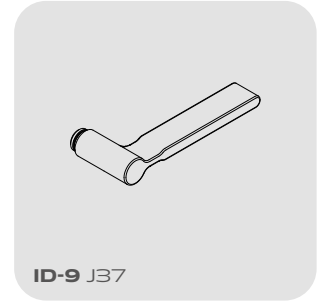

ID-9 J37



ESCALIER JO3



MONTPARNASSE JO1

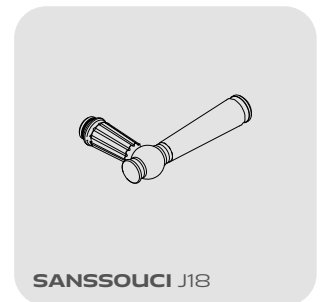



SANSSOUICI J18

Die Zertifizierung der Halbgarnituren gilt nur bei gleichzeitiger Verwendung einer ebenfalls zertifizierten Halbgarnitur auf der Gegenseite.
Zubehör für abweichende Türstärken finden Sie ab Seite 236-253

The certification of the half-sets is only valid if on the other side a certificated half-set is mounted.

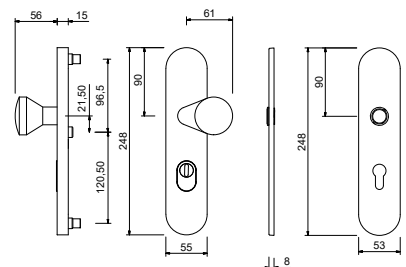
Accessories for different door thicknesses starting from page 236-253



952GF914	Bezeichnung - Description	Farbe - Finishes	Alte art. nr - Old code	1 Stück - Piece
   	<p>Schutzgarnitur System GF2, ES2 WK3 mit ZA, ohne Drückerlochteil, Außen: Schild J60, Innen: Schild J61, Vierkant 8mm, Zylinderüberstand in Kern und Kammer 10-15mm mit Knopf J04 mit 9mm VK 72 mm PZ, Türstärke 38-52mm (rechtszeigend Knopf / DIN links)</p> <p>Security Set system GF2, ES2 WK3 with cylinder protection cover, without lever, exterior: plate J60, interior: plate J61, spindle 8mm, for protruding cylinders from 10-15mm with external knob J04 72 mm Euro Profile cylinder, door thickness 38-52 (right knob / DIN left)</p>	Edelstahl Spiegelpol. - Polished Stainless Steel	952-914-572-157	1A952GF9149350DJA
		Edelstahl - Stainless steel 304	952-914-572-057	1A952GF914935SDJA

952GF914	Bezeichnung - Description	Farbe - Finishes	Alte art. nr - Old code	1 Stück - Piece
   	<p>Schutzgarnitur System GF2, ES2 WK3 mit ZA, ohne Drückerlochteil, Außen: Schild J60, Innen: Schild J61, Vierkant 8mm, Zylinderüberstand in Kern und Kammer 10-15mm mit Knopf J04 mit 9mm VK 72 mm PZ, Türstärke 38-52mm (linkszeigend Knopf / DIN rechts)</p> <p>Security Set system GF2, ES2 WK3 with cylinder protection cover, without lever, exterior: plate J60, interior: plate J61, spindle 8mm, for protruding cylinders from 10-15mm with external knob J04 72 mm Euro Profile cylinder, door thickness 38-52 (left knob / DIN right)</p>	Edelstahl Spiegelpol. - Polished Stainless Steel	952-914-472-157	1A952GF9149350SJA
		Edelstahl - Stainless steel 304	952-914-472-057	1A952GF914935SSJA

952 GF 917

EDELSTAHL - STAINLESS STEEL



PASSENDE TÜRGRIFFE
SUITABLE DOOR HANDLES

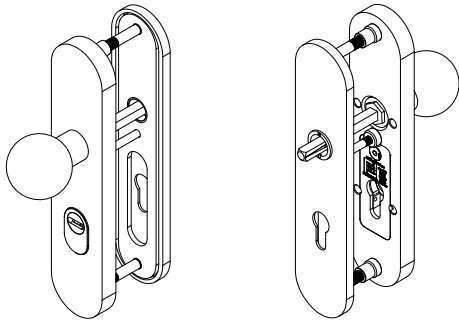

50
Edelstahl Spiegelpoliert
Polished stainless steel

5S
Edelstahl
Stainless steel 304

BAUHAUS J04

ID-9 J37

ESCALIER J03

MONTPARNASSE J01



SANSSOUICI J18

Die Zertifizierung der Halbgarnituren gilt nur bei gleichzeitiger Verwendung einer ebenfalls zertifizierten Halbgarnitur auf der Gegenseite.
Zubehör für abweichende Türstärken finden Sie ab Seite 236-253

The certification of the half-sets is only valid if on the other side a certificated half-set is mounted.

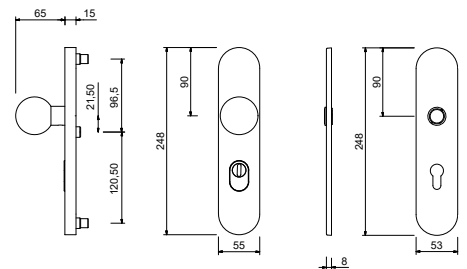
Accessories for different door thicknesses starting from page 236-253

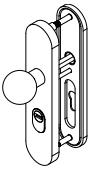
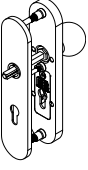

952GF917	Bezeichnung - Description	Farbe - Finishes	Alte art. nr - Old code	1 Stück - Piece
   	<p>Schutzgarnitur System GF2, ES2 WK3 mit ZA, ohne Drückerlochteil, Außen: Schild J60, Innen: Schild J61, Vierkant 8mm, Zylinderüberstand in Kern und Kammer 10-15mm mit Knopf C59 (917) mit 9mm VK 72 mm PZ, Türstärke 38-52mm</p> <p>Security Set system GF2, ES2 WK3 with cylinder protection cover, without lever, exterior: plate J60, interior: plate J61, spindle 8mm, for protruding cylinders from 10-15mm with external knob C59 (917) 72 mm Euro Profile cylinder, door thickness 38-52</p>	Edelstahl Spiegelpol. - Polished Stainless Steel	952-917-072-157	1A952GF9179350XJA
	Edelstahl - Stainless steel 304	952-917-072-057	1A952GF917935SXJA	

973 GF 914

EDELSTAHL - STAINLESS STEEL

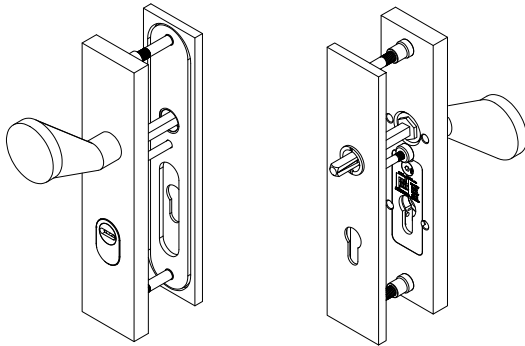

50
Edelstahl Spiegelpoliert
Polished stainless steel

5S
Edelstahl
Stainless steel 304

PASSENDE TÜRGRIFFE
SUITABLE DOOR HANDLES

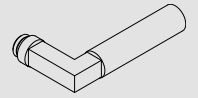

BAUHAUS JO4

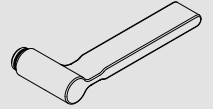

ID-9 J37

Die Zertifizierung der Halbgarnituren gilt nur bei gleichzeitiger Verwendung einer ebenfalls zertifizierten Halbgarnitur auf der Gegenseite.
Zubehör für abweichende Türstärken finden Sie ab Seite 236-253

The certification of the half-sets is only valid if on the other side a certificated half-set is mounted.

Accessories for different door thicknesses starting from page 236-253

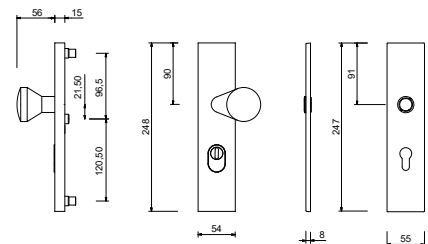

973GF914	Bezeichnung - Description	Farbe - Finishes	Alte art. nr - Old code	1 Stück - Piece
	<p>Schutzgarnitur System GF2, ES2 WK3 mit ZA, ohne Drückerlochteil, Außen: Schild J50, Innen: Schild J51, Vierkant 8mm, Zylinderüberstand in Kern und Kammer 10-15mm mit Knopf J04 mit 9mm VK 72 mm PZ, Türstärke 38-52mm (rechtszeigend Knopf / DIN links)</p> <p>Security Set system GF2, ES2 WK3 with cylinder protection cover, without lever, exterior: plate J50, interior: plate J51, spindle 8mm, for protruding cylinders from 10-15mm with external knob J04 72 mm Euro Profile cylinder, door thickness 38-52 (right knob / DIN left)</p>	Edelstahl Spiegelpol. - Polished Stainless Steel	973-914-572-157	1A973GF9149350DJA
		Edelstahl - Stainless steel 304	973-914-572-057	1A973GF914935SDJA

973GF914	Bezeichnung - Description	Farbe - Finishes	Alte art. nr - Old code	1 Stück - Piece
	<p>Schutzgarnitur System GF2, ES2 WK3 mit ZA, ohne Drückerlochteil, Außen: Schild J50, Innen: Schild J51, Vierkant 8mm, Zylinderüberstand in Kern und Kammer 10-15mm mit Knopf J04 mit 9mm VK 72 mm PZ, Türstärke 38-52mm (linkszeigend Knopf / DIN rechts)</p> <p>Security Set system GF2, ES2 WK3 with cylinder protection cover, without lever, exterior: plate J50, interior: plate J51, spindle 8mm, for protruding cylinders from 10-15mm with external knob J04 72 mm Euro Profile cylinder, door thickness 38-52 (left knob / DIN right)</p>	Edelstahl Spiegelpol. - Polished Stainless Steel	973-914-472-157	1A973GF9149350SJA
		Edelstahl - Stainless steel 304	973-914-472-057	1A973GF914935SSJA

973 GF 917

EDELSTAHL - STAINLESS STEEL

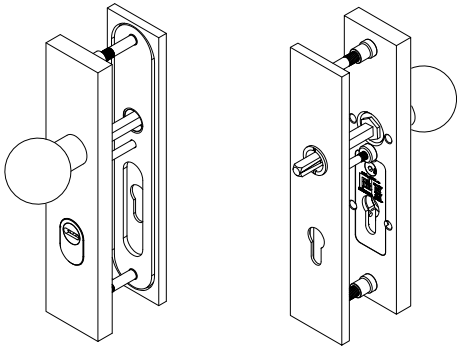

50
Edelstahl Spiegelpoliert
Polished stainless steel

5S
Edelstahl
Stainless steel 304

PASSENDE TÜRGRIFFE
SUITABLE DOOR HANDLES

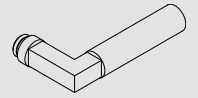

BAUHAUS JO4

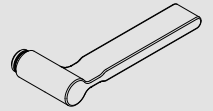



ID-9 J37

Die Zertifizierung der Halbgarnituren gilt nur bei gleichzeitiger Verwendung einer ebenfalls zertifizierten Halbgarnitur auf der Gegenseite.
Zubehör für abweichende Türstärken finden Sie ab Seite 236-253

The certification of the half-sets is only valid if on the other side a certificated half-set is mounted.

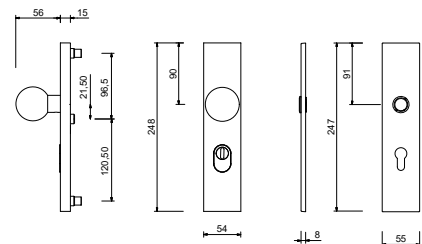
Accessories for different door thicknesses starting from page 236-253

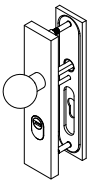
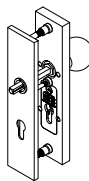

973GF917	Bezeichnung - Description	Farbe - Finishes	Alte art. nr - Old code	1 Stück - Piece
   	<p>Schutzgarnitur System GF2, ES2 WK3 mit ZA, ohne Drückerlochteil, Außen: Schild J50, Innen: Schild J51, Vierkant 8mm, Zylinderüberstand in Kern und Kammer 10-15mm mit Knopf C59 (917) mit 9mm VK 72 mm PZ, Türstärke 38-52mm</p> <p><i>Security Set system GF2, ES2 WK3 with cylinder protection cover, without lever, exterior: plate J50, interior: plate J51, spindle 8mm, for protruding cylinders from 10-15mm with external knob C59 (917) 72 mm Euro Profile cylinder, door thickness 38-52</i></p>	Edelstahl Spiegelpol. - Polished Stainless Steel	973-917-072-157	1A973GF9179350XJA
		Edelstahl - Stainless steel 304	973-917-072-057	1A973GF917935SXJA

982 GF 922

EDELSTAHL - STAINLESS STEEL

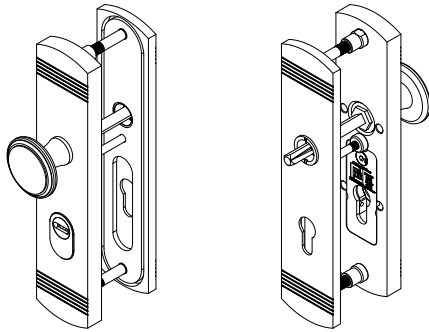

50
Edelstahl Spiegelpoliert
Polished stainless steel

5S
Edelstahl
Stainless steel 304

PASSENDE TÜRGRIFFE
SUITABLE DOOR HANDLES



ESCALIER J03

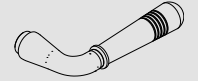

MONTPARNASSE J01

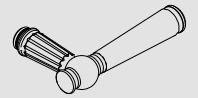

SANSSOUCI J18

Die Zertifizierung der Halbgarnituren gilt nur bei gleichzeitiger Verwendung einer ebenfalls zertifizierten Halbgarnitur auf der Gegenseite.
Zubehör für abweichende Türstärken finden Sie ab Seite 236-253

*The certification of the half-sets is only valid if on the other side a certificated half-set is mounted.
Accessories for different door thicknesses starting from page 236-253*

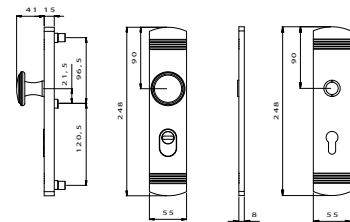

982GF922	Bezeichnung - Description	Farbe - Finishes	Alte art. nr - Old code	1 Stück - Piece
  	<p>Schutzgarnitur System GF2, ES2 WK3 mit ZA, ohne Drückerlochteil, Außen: Schild 982, Innen: Schild 353, Zylinderüberstand in Kern und Kammer 10-15mm mit Knopf J02 mit 9mm VK 72 mm PZ, Türstärke 38-52mm</p> <p>Security Set, system GF2, ES2 WK3 with cylinder protection cover, without lever, exterior: plate 982, interior: plate 922, 72mm PZ, spindle 9mm, for protruding cylinders from 10-15mm with external knob J02 72 mm Euro Profile cylinder, door thickness 38-52</p>	Edelstahl Spiegelpol. - Polished Stainless Steel	982-922-072-157	1A982GF9229350XJA
		Edelstahl - Stainless steel 304	982-922-072-057	1A982GF922935SXJA





 JATEC

SCHUTZGARNITUREN

SECURITY SET

953 GF 420



PASSENDE TÜRGRIFFE
SUITABLE DOOR HANDLES

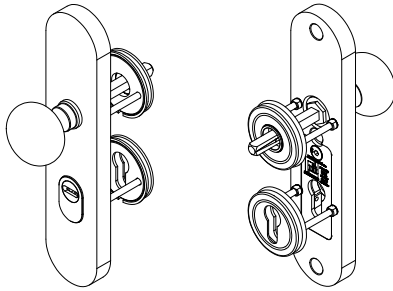

5S
Edelstahl
Stainless steel 304



98
LIGHTHOUSE J36

Zubehör für abweichende Türstärken finden Sie ab Seite 236-253

Accessories for different door thicknesses starting from page 236-253

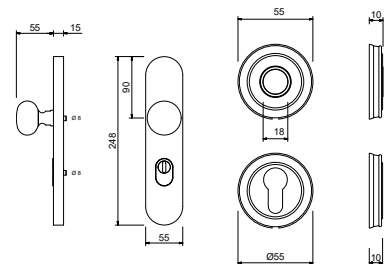

953GF420	Bezeichnung - Description	Farbe - Finishes	Alte art. nr - Old code	1 Stück - Piece
 	<p>Schutzgarnitur System GF1, ES1 WK2 mit ZA, ohne Drückerlochteil, Außen: Schild J62, Innen: Rosetten J36, Vierkant 8mm, Zylinderüberstand in Kern und Kammer 10-15mm mit Knopf J01 72 mm PZ, Türstärke 38-50mm</p> <p><i>Security Set system GF1, ES1 WK2 with cylinder protection cover, without lever, exterior: plate J62, interior: rosettes J36, spindle 8mm, for protruding cylinders from 10-15mm with external knob J01 72 mm Euro Profile cylinder, door thickness 38-50</i></p>	Edelstahl - Stainless steel 304	953-420-072-057	1A953GF420135XJA

953GF420	Bezeichnung - Description	Farbe - Finishes	Alte art. nr - Old code	1 Stück - Piece
 	<p>Schutzgarnitur System GF1, ES1 WK2 mit ZA, ohne Drückerlochteil, Außen: Schild J62, Innen: Rosetten J36, Vierkant 10mm, Zylinderüberstand in Kern und Kammer 10-15mm mit Knopf J01 92 mm PZ, Türstärke 68-82mm</p> <p><i>Security Set system GF1, ES1 WK2 with cylinder protection cover, without lever, exterior: plate J62, interior: rosettes J36, spindle 10mm, for protruding cylinders from 10-15mm with external knob J01 92 mm Euro Profile cylinder, door thickness 68-82</i></p>	Edelstahl - Stainless steel 304	953-420-092-057	1A953GF420155XJA

955 GF 420

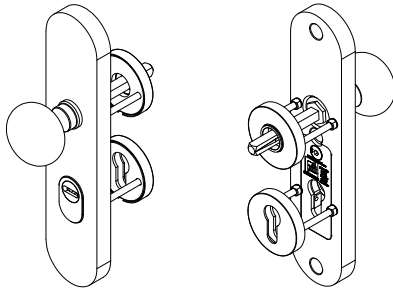

46
Ultra Messing
PVD Gold

5S
Edelstahl
Stainless steel 304

PASSENDE TÜRGRIFFE SUITABLE DOOR HANDLES

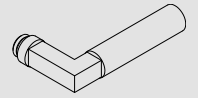

46 | 5S
BAUHAUS J04

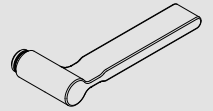

5S
ID-9 J37



5S
PURE J26

Zubehör für abweichende Türstärken finden Sie ab Seite 236-253

Accessories for different door thicknesses starting from page 236-253

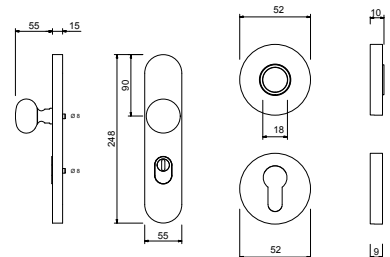

955GF420	Bezeichnung - Description	Farbe - Finishes	Alte art. nr - Old code	1 Stück - Piece
  	<p>Schutzgarnitur System GF1, ES1 WK2 mit ZA, ohne Drückerlochteil, Außen: Schild J62, Innen: Rosetten J01, Vierkant 8mm, Zylinderüberstand in Kern und Kammer 10-15mm mit Knopf J01 72 mm PZ, Türstärke 38-50mm</p> <p><i>Security Set system GF1, ES1 WK2 with cylinder protection cover, without lever, exterior: plate J62, interior: rosettes J01, spindle 8mm, for protruding cylinders from 10-15mm with external knob J01 72 mm Euro Profile cylinder, door thickness 38-50</i></p>	Ultra Messing - PVD Gold 	955-420-072-367	1A955GF4201346XJA
		Edelstahl - Stainless steel 304	955-420-072-057	1A955GF420135SXJA

955GF420	Bezeichnung - Description	Farbe - Finishes	Alte art. nr - Old code	1 Stück - Piece
  	<p>Schutzgarnitur System GF1, ES1 WK2 mit ZA, ohne Drückerlochteil, Außen: Schild J62, Innen: Rosetten J01, Vierkant 10mm, Zylinderüberstand in Kern und Kammer 10-15mm mit Knopf J01 92 mm PZ, Türstärke 68-82mm</p> <p><i>Security Set system GF1, ES1 WK2 with cylinder protection cover, without lever, exterior: plate J62, interior: rosettes J01, spindle 10mm, for protruding cylinders from 10-15mm with external knob J01 92 mm Euro Profile cylinder, door thickness 68-82</i></p>	Ultra Messing - PVD Gold 	955-420-092-367	1A955GF4201546XJA
		Edelstahl - Stainless steel 304	955-420-092-057	1A955GF420155SXJA

976 GF 373

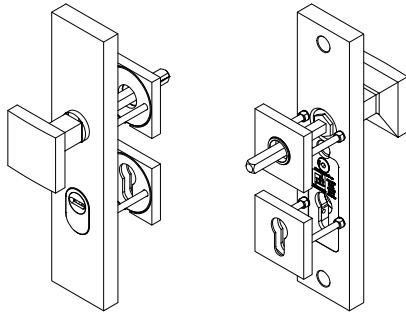

05
Chrom
Polished chrome

5S
Edelstahl
Stainless steel 304

PASSENDE TÜRGRIFFE SUITABLE DOOR HANDLES

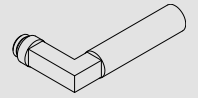

05 | 5S
BAUHAUS J04



05
IQ-CARRE J27



05 | 5S
PURE J26

Zubehör für abweichende Türstärken finden Sie ab Seite 236-253

Accessories for different door thicknesses starting from page 236-253

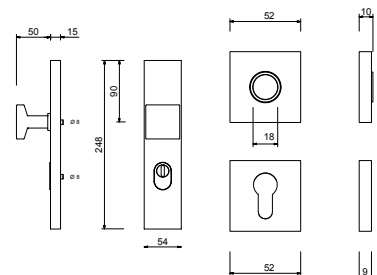

976GF373	Bezeichnung - Description	Farbe - Finishes	Alte art. nr - Old code	1 Stück - Piece
 	<p>Schutzgarnitur System GF1, ES1 WK2 mit ZA, ohne Drückerlochteil, Außen: Schild J52, Innen: Rosetten J30, Vierkant 8mm, Zylinderüberstand in Kern und Kammer 10-15mm mit Knopf J03 72 mm PZ, Türstärke 38-50mm</p> <p><i>Security Set system GF1, ES1 WK2 with cylinder protection cover, without lever, exterior: plate J52, interior: rosettes J30, spindle 8mm, for protruding cylinders from 10-15mm with external knob J03 72 mm Euro Profile cylinder, door thickness 38-50</i></p>	Chrom - Polished chrome	976-373-072-000	1A976GF3731305XJA
		Edelstahl - Stainless steel 304	976-373-072-057	1A976GF373135SXJA

976GF373	Bezeichnung - Description	Farbe - Finishes	Alte art. nr - Old code	1 Stück - Piece
 	<p>Schutzgarnitur System GF1, ES1 WK2 mit ZA, ohne Drückerlochteil, Außen: Schild J52, Innen: Rosetten J30, Vierkant 10mm, Zylinderüberstand in Kern und Kammer 10-15mm mit Knopf J03 92 mm PZ, Türstärke 68-82mm</p> <p><i>Security Set system GF1, ES1 WK2 with cylinder protection cover, without lever, exterior: plate J52, interior: rosettes J30, spindle 10mm, for protruding cylinders from 10-15mm with external knob J03 92 mm Euro Profile cylinder, door thickness 68-82</i></p>	Chrom - Polished chrome	976-373-092-000	1A976GF3731505XJA
		Edelstahl - Stainless steel 304	976-373-092-057	1A976GF373155SXJA

976 GF 374

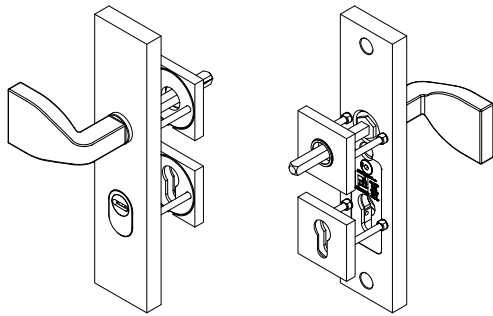

05
Chrom
Polished chrome

5S
Edelstahl
Stainless steel 304

PASSENDE TÜRGRIFFE SUITABLE DOOR HANDLES

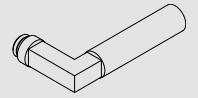

05 | 5S
BAUHAUS J04



05
IQ-CARRE J27







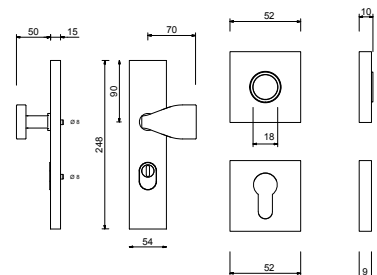

05 | 5S
PURE J26

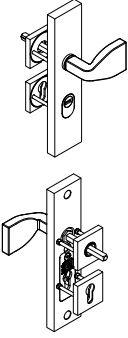
Zubehör für abweichende Türstärken finden Sie ab Seite 236-253

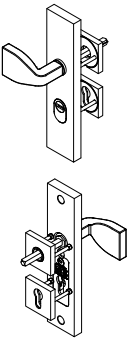
Accessories for different door thicknesses starting from page 236-253

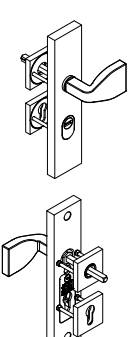

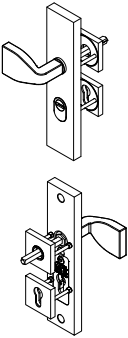
976GF374	Bezeichnung - Description	Farbe - Finishes	Alte art. nr - Old code	1 Stück - Piece
 	<p>Schutzgarnitur System GF1, ES1 WK2 mit ZA, ohne Drückerlochteil, Außen: Schild J52, Innen: Rosetten J30, Vierkant 8mm, Zylinderüberstand in Kern und Kammer 10-15mm mit Knopf J05 72 mm PZ, Türstärke 38-50mm (rechtszeigend Knopf / DIN links)</p> <p><i>Security Set system GF1, ES1 WK2 with cylinder protection cover, without lever, exterior: plate J52, interior: rosettes J30, spindle 8mm, for protruding cylinders from 10-15mm with external knob J05 72 mm Euro Profile cylinder, door thickness 38-50 (right knob / DIN left)</i></p>	<p>Chrom - Polished chrome Edelstahl - Stainless steel 304</p>	<p>976-374-572-000 976-374-572-057</p>	<p>1A976GF3741305DJA 1A976GF374135SDJA</p>
 	<p>Schutzgarnitur System GF1, ES1 WK2 mit ZA, ohne Drückerlochteil, Außen: Schild J52, Innen: Rosetten J30, Vierkant 8mm, Zylinderüberstand in Kern und Kammer 10-15mm mit Knopf J05 72 mm PZ, Türstärke 38-50mm (linkszeigend Knopf / DIN rechts)</p> <p><i>Security Set system GF1, ES1 WK2 with cylinder protection cover, without lever, exterior: plate J52, interior: rosettes J30, spindle 8mm, for protruding cylinders from 10-15mm with external knob J05 72 mm Euro Profile cylinder, door thickness 38-50 (left knob / DIN right)</i></p>	<p>Chrom - Polished chrome Edelstahl - Stainless steel 304</p>	<p>976-374-472-000 976-374-472-057</p>	<p>1A976GF3741305SJA 1A976GF374135SSJA</p>
 	<p>Schutzgarnitur System GF1, ES1 WK2 mit ZA, ohne Drückerlochteil, Außen: Schild J52, Innen: Rosetten J30, Vierkant 10mm, Zylinderüberstand in Kern und Kammer 10-15mm mit Knopf J05 92 mm PZ, Türstärke 68-82mm (rechtszeigend Knopf / DIN links)</p> <p><i>Security Set system GF1, ES1 WK2 with cylinder protection cover, without lever, exterior: plate J52, interior: rosettes J30, spindle 10mm, for protruding cylinders from 10-15mm with external knob J05 92 mm Euro Profile cylinder, door thickness 68-82 (right knob / DIN left)</i></p>	<p>Chrom - Polished chrome Edelstahl - Stainless steel 304</p>	<p>976-374-592-000 976-374-592-057</p>	<p>1A976GF3741505DJA 1A976GF374155SDJA</p>
 	<p>Schutzgarnitur System GF1, ES1 WK2 mit ZA, ohne Drückerlochteil, Außen: Schild J52, Innen: Rosetten J30, Vierkant 10mm, Zylinderüberstand in Kern und Kammer 10-15mm mit Knopf J05 92 mm PZ, Türstärke 68-82mm (linkszeigend Knopf / DIN rechts)</p> <p><i>Security Set system GF1, ES1 WK2 with cylinder protection cover, without lever, exterior: plate J52, interior: rosettes J30, spindle 10mm, for protruding cylinders from 10-15mm with external knob J05 92 mm Euro Profile cylinder, door thickness 68-82 (left knob / DIN right)</i></p>	<p>Chrom - Polished chrome Edelstahl - Stainless steel 304</p>	<p>976-374-492-000 976-374-492-057</p>	<p>1A976GF3741505SJA 1A976GF374155SSJA</p>

993 GF 922

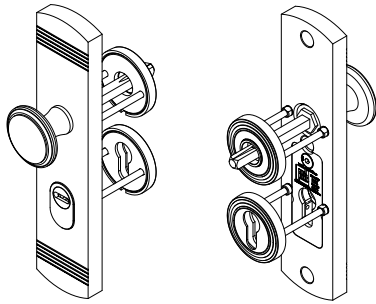

5S
Edelstahl
Stainless steel 304

PASSENDE TÜRGRIFFE SUITABLE DOOR HANDLES



98
ESCALIER J03

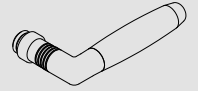

6P
METROPOL HOLZ J35

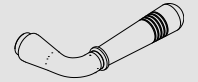

98
MONTPARNASSE J01

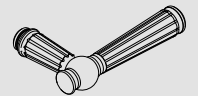



5S
SANSSOUCI J18

Zubehör für abweichende Türstärken finden Sie ab Seite 236-253

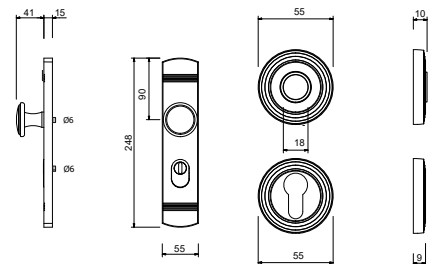
Accessories for different door thicknesses starting from page 236-253

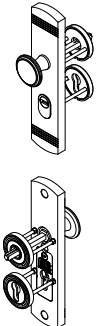

993GF922	Bezeichnung - Description	Farbe - Finishes	Alte art. nr - Old code	1 Stück - Piece
 	<p>Schutzgarnitur System GF1, ES1 WK2 mit ZA, ohne Drückerlochteil, Außen: Schild J77, Innen: Rosetten J03, Vierkant 8mm, Zylinderüberstand in Kern und Kammer 10-15mm mit Knopf J02 72 mm PZ, Türstärke 38-50mm</p> <p><i>Security Set system GF1, ES1 WK2 with cylinder protection cover, without lever, exterior: plate J77, interior: rosette J03, spindle 8mm, for protruding cylinders from 10-15mm with external knob J02 72 mm Euro Profile cylinder, door thickness 38-50</i></p>	Edelstahl - Stainless steel 304	993-922-072-057	1A993GF922135SXJA

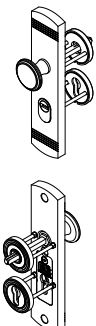
993GF922	Bezeichnung - Description	Farbe - Finishes	Alte art. nr - Old code	1 Stück - Piece
 	<p>Schutzgarnitur System GF1, ES1 WK2 mit ZA, ohne Drückerlochteil, Außen: Schild J77, Innen: Rosetten J03, Vierkant 10mm, Zylinderüberstand in Kern und Kammer 10-15mm mit Knopf J02 92 mm PZ, Türstärke 68-82mm</p> <p><i>Security Set system GF1, ES1 WK2 with cylinder protection cover, without lever, exterior: plate J77, interior: rosette J03, spindle 10mm, for protruding cylinders from 10-15mm with external knob J02 92 mm Euro Profile cylinder, door thickness 68-82</i></p>	Edelstahl - Stainless steel 304	993-922-092-057	1A993GF922155SXJA

952 GF 914



PASSENDE TÜRGRIFFE SUITABLE DOOR HANDLES

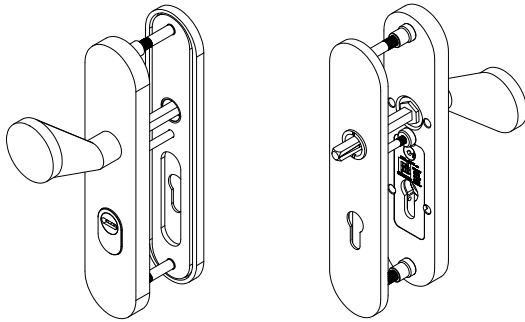



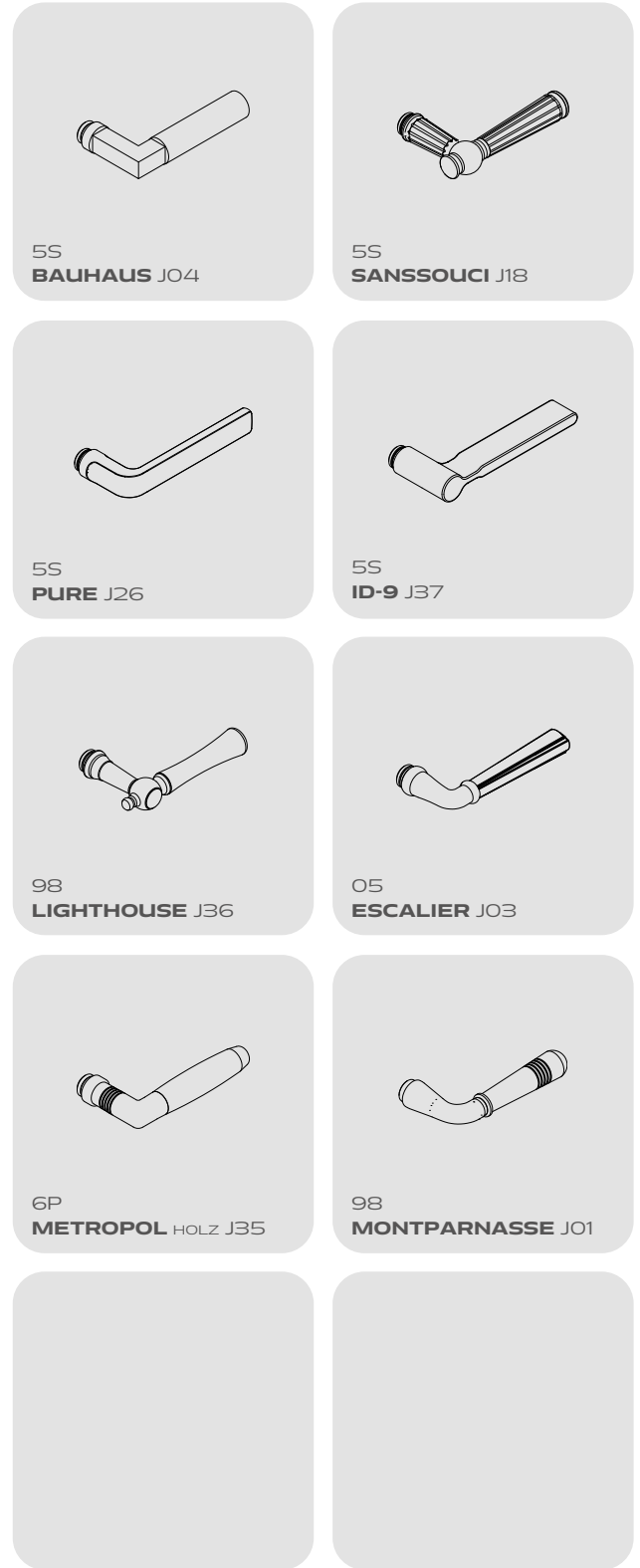



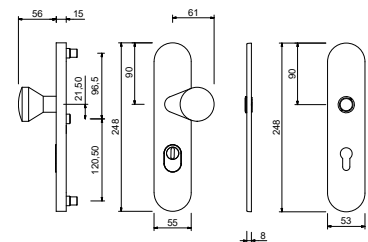

5S
Edelstahl
Stainless steel 304

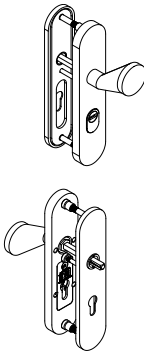

Zubehör für abweichende Türstärken finden Sie ab Seite 236-253

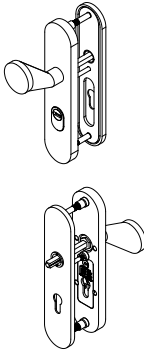
Accessories for different door thicknesses starting from page 236-253

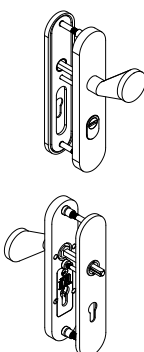

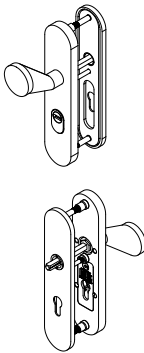
952GF914	Bezeichnung - Description	Farbe - Finishes	Alte art. nr - Old code	1 Stück - Piece
 	<p>Schutzgarnitur System GF2, ES2 WK3 mit ZA, ohne Drückerlochteil, Außen: Schild J60, Innen: Schild J61, Vierkant 8mm, Zylinderüberstand in Kern und Kammer 10-15mm mit Knopf J04 72 mm PZ, Türstärke 38-50mm (rechtszeigend Knopf / DIN links)</p> <p><i>Security Set system GF2, ES2 WK3 with cylinder protection cover, without lever, exterior: plate J60, interior: plate J61, spindle 8mm, for protruding cylinders from 10-15mm with external knob J04 72 mm Euro Profile cylinder, door thickness 38-50 (right knob / DIN left)</i></p>	Edelstahl - Stainless steel 304	952-914-572-057	1A952GF914135SDJA
 	<p>Schutzgarnitur System GF2, ES2 WK3 mit ZA, ohne Drückerlochteil, Außen: Schild J60, Innen: Schild J61, Vierkant 8mm, Zylinderüberstand in Kern und Kammer 10-15mm mit Knopf J04 72 mm PZ, Türstärke 38-50mm (linkszeigend Knopf / DIN rechts)</p> <p><i>Security Set system GF2, ES2 WK3 with cylinder protection cover, without lever, exterior: plate J60, interior: plate J61, spindle 8mm, for protruding cylinders from 10-15mm with external knob J04 72 mm Euro Profile cylinder, door thickness 38-50 (left knob / DIN right)</i></p>	Edelstahl - Stainless steel 304	952-914-472-057	1A952GF914135SSJA
 	<p>Schutzgarnitur System GF2, ES2 WK3 mit ZA, ohne Drückerlochteil, Außen: Schild J60, Innen: Schild J61, Vierkant 10mm, Zylinderüberstand in Kern und Kammer 10-15mm mit Knopf J04 92 mm PZ, Türstärke 68-82mm (rechtszeigend Knopf / DIN links)</p> <p><i>Security Set system GF2, ES2 WK3 with cylinder protection cover, without lever, exterior: plate J60, interior: plate J61, spindle 10mm, for protruding cylinders from 10-15mm with external knob J04 92 mm Euro Profile cylinder, door thickness 68-82 (right knob / DIN left)</i></p>	Edelstahl - Stainless steel 304	952-914-592-057	1A952GF914155SDJA
 	<p>Schutzgarnitur System GF2, ES2 WK3 mit ZA, ohne Drückerlochteil, Außen: Schild J60, Innen: Schild J61, Vierkant 10mm, Zylinderüberstand in Kern und Kammer 10-15mm mit Knopf J04 92 mm PZ, Türstärke 68-82mm (linkszeigend Knopf / DIN rechts)</p> <p><i>Security Set system GF2, ES2 WK3 with cylinder protection cover, without lever, exterior: plate J60, interior: plate J61, spindle 10mm, for protruding cylinders from 10-15mm with external knob J04 92 mm Euro Profile cylinder, door thickness 68-82 (left knob / DIN right)</i></p>	Edelstahl - Stainless steel 304	952-914-492-057	1A952GF914155SSJA

973 GF 373

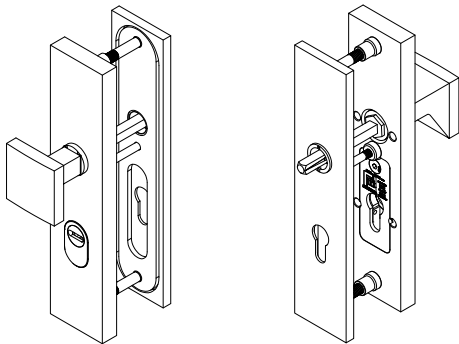

5S
Edelstahl
Stainless steel 304

PASSENDE TÜRGRIFFE SUITABLE DOOR HANDLES

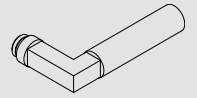

5S
BAUHAUS J04

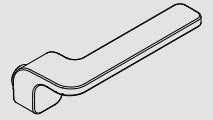

5S
FLUX J20

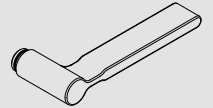

5S
ID-9 J37





5S
PURE J26

Zubehör für abweichende Türstärken finden Sie ab Seite 236-253

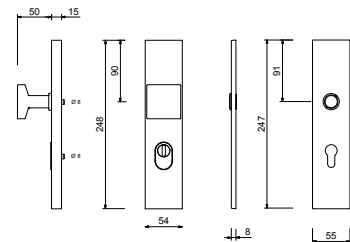
Accessories for different door thicknesses starting from page 236-253

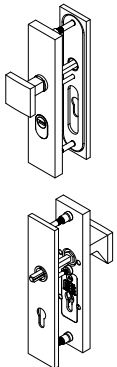

973GF373	Bezeichnung - Description	Farbe - Finishes	Alte art. nr - Old code	1 Stück - Piece
 	<p>Schutzgarnitur System GF2, ES2 WK3 mit ZA, ohne Drückerlochteil, Außen: Schild J50, Innen: Schild J51, Vierkant 8mm, Zylinderüberstand in Kern und Kammer 10-15mm mit Knopf J03 72 mm PZ, Türstärke 38-50mm</p> <p><i>Security Set system GF2, ES2 WK3 with cylinder protection cover, without lever, exterior: plate J50, interior: plate J51, spindle 8mm, for protruding cylinders from 10-15mm with external knob J03 72 mm Euro Profile cylinder, door thickness 38-50</i></p>	Edelstahl - Stainless steel 304	973-373-072-057	1A973GF373135SXJA

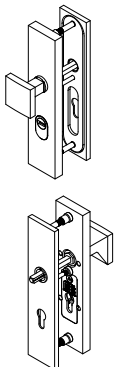
973GF373	Bezeichnung - Description	Farbe - Finishes	Alte art. nr - Old code	1 Stück - Piece
 	<p>Schutzgarnitur System GF2, ES2 WK3 mit ZA, ohne Drückerlochteil, Außen: Schild J50, Innen: Schild J51, Vierkant 10mm, Zylinderüberstand in Kern und Kammer 10-15mm mit Knopf J03 92 mm PZ, Türstärke 68-82mm</p> <p><i>Security Set system GF2, ES2 WK3 with cylinder protection cover, without lever, exterior: plate J50, interior: plate J51, spindle 10mm, for protruding cylinders from 10-15mm with external knob J03 92 mm Euro Profile cylinder, door thickness 68-82</i></p>	Edelstahl - Stainless steel 304	973-373-092-057	1A973GF373155SXJA

973 GF 374

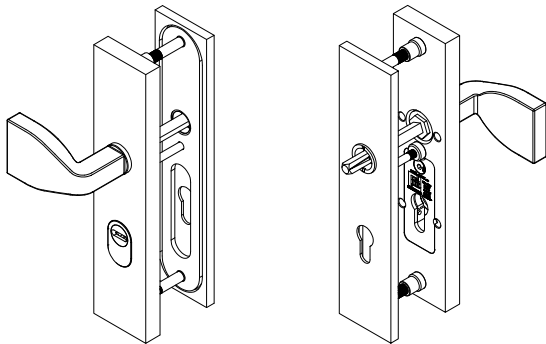

- 05**
Chrom
Polished chrome
- 50**
Edelstahl Spiegelpoliert
Polished stainless steel

- 46**
Ultra Messing
PVD Gold
- 5S**
Edelstahl
Stainless steel 304

PASSENDE TÜRGRIFFE SUITABLE DOOR HANDLES

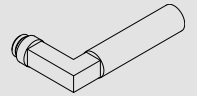

05 | 46 | 5S | K1
BAUHAUS J04

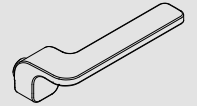

05 | 5S
FLUX J20



05
IQ-CARRE J27

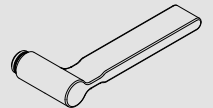

05 | 5S
ID-9 J37





05 | 5S
PURE J26

Zubehör für abweichende Türstärken finden Sie ab Seite 236-253

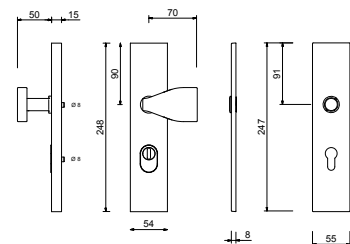
Accessories for different door thicknesses starting from page 236-253

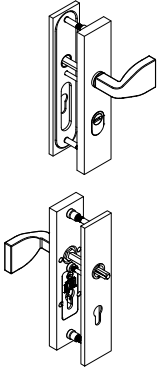

973GF374	Bezeichnung - Description	Farbe - Finishes	Alte art. nr - Old code	1 Stück - Piece
 	<p>Schutzgarnitur System GF2, ES2 WK3 mit ZA, ohne Drückerlochteil, Außen: Schild J50, Innen: Schild J51, Vierkant 8mm, Zylinderüberstand in Kern und Kammer 10-15mm mit Knopf J05 72 mm PZ, Türstärke 38-50mm (rechtszeigend Knopf / DIN links)</p> <p><i>Security Set system GF2, ES2 WK3 with cylinder protection cover, without lever, exterior: plate J50, interior: plate J51, spindle 8mm, for protruding cylinders from 10-15mm with external knob J05 72 mm Euro Profile cylinder, door thickness 38-50 (right knob / DIN left)</i></p>	Chrom - Polished chrome	973-374-572-000	1A973GF3741305DJA
		Ultra Messing - PVD Gold	973-374-572-367	1A973GF3741346DJA
		Edelstahl Spiegelpol. - Polished Stainless Steel	973-374-572-157	1A973GF3741350DJA
		Edelstahl - Stainless steel 304	973-374-572-057	1A973GF374135SDJA

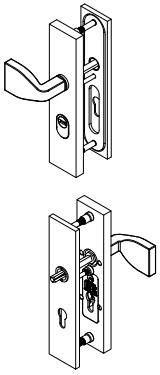
 	<p>Schutzgarnitur System GF2, ES2 WK3 mit ZA, ohne Drückerlochteil, Außen: Schild J50, Innen: Schild J51, Vierkant 8mm, Zylinderüberstand in Kern und Kammer 10-15mm mit Knopf J05 72 mm PZ, Türstärke 38-50mm (linkszeigend Knopf / DIN rechts)</p> <p><i>Security Set system GF2, ES2 WK3 with cylinder protection cover, without lever, exterior: plate J50, interior: plate J51, spindle 8mm, for protruding cylinders from 10-15mm with external knob J05 72 mm Euro Profile cylinder, door thickness 38-50 (left knob / DIN right)</i></p>	Chrom - Polished chrome	973-374-472-000	1A973GF3741305SJA
		Ultra Messing - PVD Gold	973-374-472-367	1A973GF3741346SJA
		Edelstahl Spiegelpol. - Polished Stainless Steel	973-374-472-157	1A973GF3741350SJA
		Edelstahl - Stainless steel 304	973-374-472-057	1A973GF374135SSJA

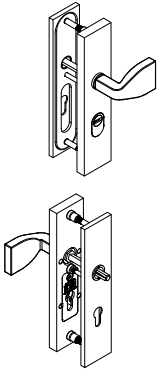
973GF374	Bezeichnung - Description	Farbe - Finishes	Alte art. nr - Old code	1 Stück - Piece
 	<p>Schutzgarnitur System GF2, ES2 WK3 mit ZA, ohne Drückerlochteil, Außen: Schild J50, Innen: Schild J51, Vierkant 10mm, Zylinderüberstand in Kern und Kammer 10-15mm mit Knopf J05 92 mm PZ, Türstärke 68-82mm (rechtszeigend Knopf / DIN links)</p> <p><i>Security Set system GF2, ES2 WK3 with cylinder protection cover, without lever, exterior: plate J50, interior: plate J51, spindle 10mm, for protruding cylinders from 10-15mm with external knob J05 92 mm Euro Profile cylinder, door thickness 68-82 (right knob / DIN left)</i></p>	Chrom - Polished chrome	973-374-592-000	1A973GF3741505DJA
		Ultra Messing - PVD Gold	973-374-592-367	1A973GF3741546DJA
		Edelstahl Spiegelpol. - Polished Stainless Steel	973-374-592-157	1A973GF3741550DJA
		Edelstahl - Stainless steel 304	973-374-592-057	1A973GF374155SDJA

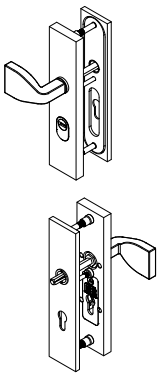
 	<p>Schutzgarnitur System GF2, ES2 WK3 mit ZA, ohne Drückerlochteil, Außen: Schild J50, Innen: Schild J51, Vierkant 10mm, Zylinderüberstand in Kern und Kammer 10-15mm mit Knopf J05 92 mm PZ, Türstärke 68-82mm (linkszeigend Knopf / DIN rechts)</p> <p><i>Security Set system GF2, ES2 WK3 with cylinder protection cover, without lever, exterior: plate J50, interior: plate J51, spindle 10mm, for protruding cylinders from 10-15mm with external knob J05 92 mm Euro Profile cylinder, door thickness 68-82 (left knob / DIN right)</i></p>	Chrom - Polished chrome	973-374-492-000	1A973GF3741505SJA
		Ultra Messing - PVD Gold	973-374-492-367	1A973GF3741546SJA
		Edelstahl Spiegelpol. - Polished Stainless Steel	973-374-492-157	1A973GF3741550SJA
		Edelstahl - Stainless steel 304	973-374-492-057	1A973GF374155SSJA

351 GF 420

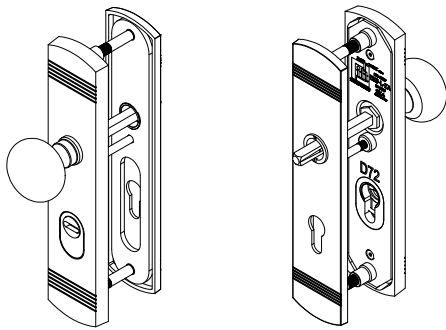

05
Chrom
Polished chrome

98
Ultra Mattnickel
PVD Satin inox

46
Ultra Messing
PVD Gold

PASSENDE TÜRGRIFFE SUITABLE DOOR HANDLES

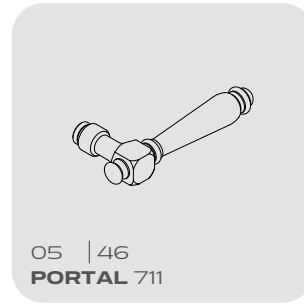
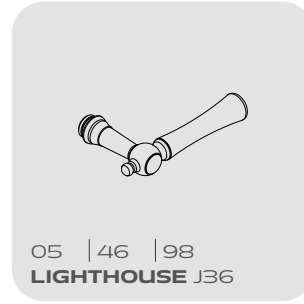
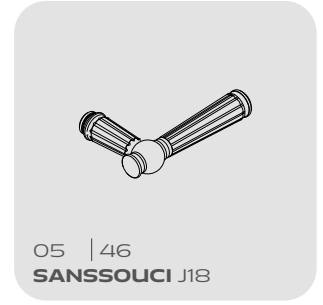
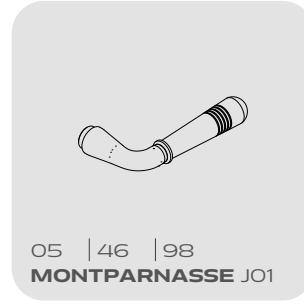
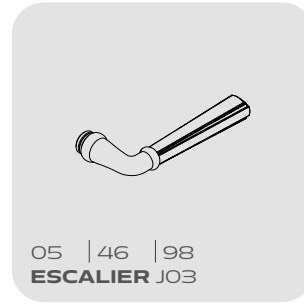

Zubehör für abweichende Türstärken finden Sie ab Seite 236-253

Accessories for different door thicknesses starting from page 236-253

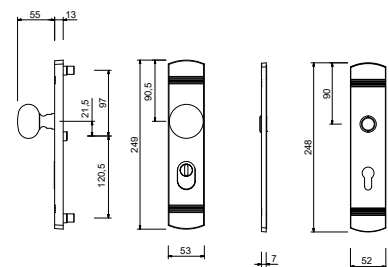

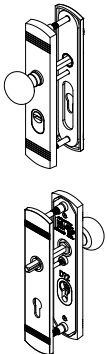
351GF420	Bezeichnung - Description	Farbe - Finishes	Alte art. nr - Old code	1 Stück - Piece
 	<p>Schutzgarnitur System GF3, ES3 WK4 mit ZA, ohne Drückerlochteil, Außen: Schild J73, Innen: Schild J71, Vierkant 8mm, Zylinderüberstand in Kern und Kammer 7-12mm mit Knopf J01 72 mm PZ, Türstärke 38-50mm</p> <p><i>Security Set system GF3, ES3 WK4 with cylinder protection cover, without lever, exterior: plate J73, interior: plate J71, spindle 8mm, for protruding cylinders from 7-12mm with external knob J01 72 mm Euro Profile cylinder, door thickness 38-50</i></p>	Chrom - Polished chrome	351-420-072-000	1A351GF4201305XJA
		Ultra Messing - PVD Gold	351-420-072-367	1A351GF4201346XJA
		Ultra Mattnickel - PVD Satin inox	351-420-072-066	1A351GF4201398XJA

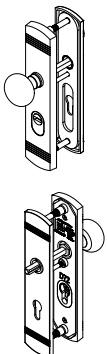
351GF420	Bezeichnung - Description	Farbe - Finishes	Alte art. nr - Old code	1 Stück - Piece
 	<p>Schutzgarnitur System GF3, ES3 WK4 mit ZA, ohne Drückerlochteil, Außen: Schild J73, Innen: Schild J71, Vierkant 10mm, Zylinderüberstand in Kern und Kammer 7-12mm mit Knopf J01 92 mm PZ, Türstärke 68-82mm</p> <p><i>Security Set system GF3, ES3 WK4 with cylinder protection cover, without lever, exterior: plate J73, interior: plate J71, spindle 10mm, for protruding cylinders from 7-12mm with external knob J01 92 mm Euro Profile cylinder, door thickness 68-82</i></p>	Chrom - Polished chrome	351-420-092-000	1A351GF4201505XJA
		Ultra Messing - PVD Gold	351-420-092-367	1A351GF4201546XJA
		Ultra Mattnickel - PVD Satin inox	351-420-092-066	1A351GF4201598XJA

351 GF 421

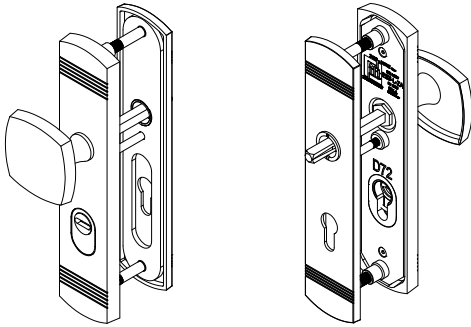

05
Chrom
Polished chrome

98
Ultra Mattnickel
PVD Satin inox

46
Ultra Messing
PVD Gold

PASSENDE TÜRGRIFFE SUITABLE DOOR HANDLES

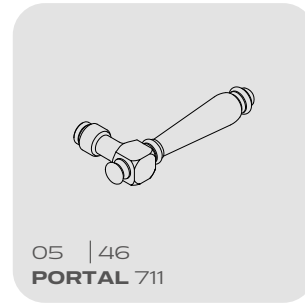
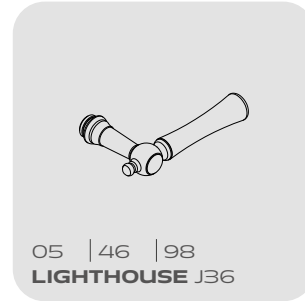
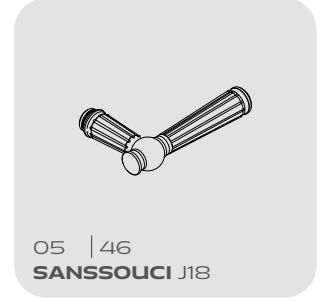

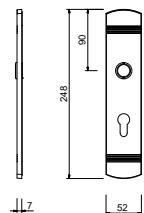
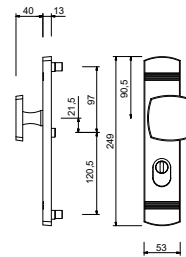

Zubehör für abweichende Türstärken finden Sie ab Seite 236-253

Accessories for different door thicknesses starting from page 236-253

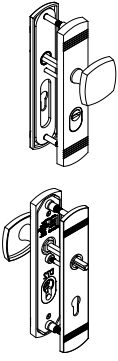

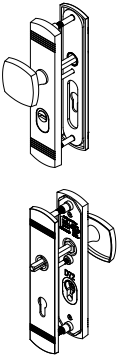
351GF421	Bezeichnung - Description	Farbe - Finishes	Alte art. nr - Old code	1 Stück - Piece
 	<p>Schutzgarnitur System GF3, ES3 WK4 mit ZA, ohne Drückerlochteil, Außen: Schild J73, Innen: Schild J71, Vierkant 8mm, Zylinderüberstand in Kern und Kammer 7-12mm mit Knopf J07 72 mm PZ, Türstärke 38-50mm (rechtszeigend Knopf / DIN links)</p> <p>Security Set system GF3, ES3 WK4 with cylinder protection cover, without lever, exterior: plate J73, interior: plate J71, spindle 8mm, for protruding cylinders from 7-12mm with external knob J07 72 mm Euro Profile cylinder, door thickness 38-50 (right knob / DIN left)</p>	Chrom - Polished chrome	351-421-572-000	1A351GF4211305DJA
		Ultra Messing - PVD Gold	351-421-572-367	1A351GF4211346DJA
		Ultra Mattnickel - PVD Satin inox	351-421-572-066	1A351GF4211398DJA

 	<p>Schutzgarnitur System GF3, ES3 WK4 mit ZA, ohne Drückerlochteil, Außen: Schild J73, Innen: Schild J71, Vierkant 8mm, Zylinderüberstand in Kern und Kammer 7-12mm mit Knopf J07 72 mm PZ, Türstärke 38-50mm (linkszeigend Knopf / DIN rechts)</p> <p>Security Set system GF3, ES3 WK4 with cylinder protection cover, without lever, exterior: plate J73, interior: plate J71, spindle 8mm, for protruding cylinders from 7-12mm with external knob J07 72 mm Euro Profile cylinder, door thickness 38-50 (left knob / DIN right)</p>	Chrom - Polished chrome	351-421-472-000	1A351GF4211305SJA
		Ultra Messing - PVD Gold	351-421-472-367	1A351GF4211346SJA
		Ultra Mattnickel - PVD Satin inox	351-421-472-066	1A351GF4211398SJA

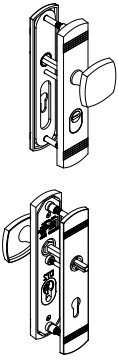
351GF421	Bezeichnung - Description	Farbe - Finishes	Alte art. nr - Old code	1 Stück - Piece
 	<p>Schutzgarnitur System GF3, ES3 WK4 mit ZA, ohne Drückerlochteil, Außen: Schild J73, Innen: Schild J71, Vierkant 10mm, Zylinderüberstand in Kern und Kammer 7-12mm mit Knopf J07 92 mm PZ, Türstärke 68-82mm (rechtszeigend Knopf / DIN links)</p> <p>Security Set system GF3, ES3 WK4 with cylinder protection cover, without lever, exterior: plate J73, interior: plate J71, spindle 10mm, for protruding cylinders from 7-12mm with external knob J07 92 mm Euro Profile cylinder, door thickness 68-82 (right knob / DIN left)</p>	Chrom - Polished chrome	351-421-592-000	1A351GF4211505DJA
		Ultra Messing - PVD Gold	351-421-592-367	1A351GF4211546DJA
		Ultra Mattnickel - PVD Satin inox	351-421-592-066	1A351GF4211598DJA

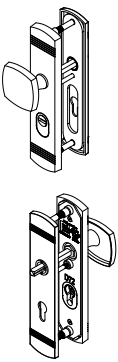
 	<p>Schutzgarnitur System GF3, ES3 WK4 mit ZA, ohne Drückerlochteil, Außen: Schild J73, Innen: Schild J71, Vierkant 10mm, Zylinderüberstand in Kern und Kammer 7-12mm mit Knopf J07 92 mm PZ, Türstärke 68-82mm (linkszeigend Knopf / DIN rechts)</p> <p>Security Set system GF3, ES3 WK4 with cylinder protection cover, without lever, exterior: plate J73, interior: plate J71, spindle 10mm, for protruding cylinders from 7-12mm with external knob J07 92 mm Euro Profile cylinder, door thickness 68-82 (left knob / DIN right)</p>	Chrom - Polished chrome	351-421-492-000	1A351GF4211505SJA
		Ultra Messing - PVD Gold	351-421-492-367	1A351GF4211546SJA
		Ultra Mattnickel - PVD Satin inox	351-421-492-066	1A351GF4211598SJA

351 GF 922

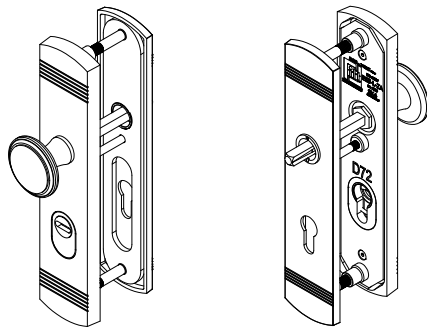

05
Chrom
Polished chrome

98
Ultra Mattnickel
PVD Satin inox

46
Ultra Messing
PVD Gold

PASSENDE TÜRGRIFFE SUITABLE DOOR HANDLES

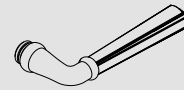

05 | 46 | 98
ESCALIER J03

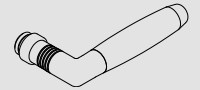

L6 | 6P
METROPOL HOLZ J35

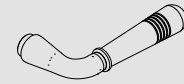

05 | 46 | 98
MONTPARNASSE J01

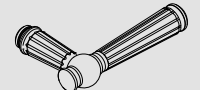

05 | 46
SANSSOUCI J18

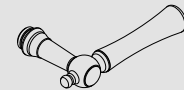

05 | 46 | 98
LIGHTHOUSE J36



05 | 46
SCHÖNBRUNN J14

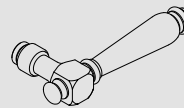



05 | 46
PORTAL 711

Zubehör für abweichende Türstärken finden Sie ab Seite 236-253

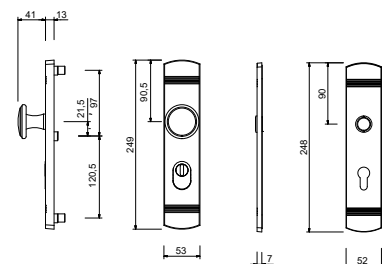
Accessories for different door thicknesses starting from page 236-253



351GF922	Bezeichnung - Description	Farbe - Finishes	Alte art. nr - Old code	1 Stück - Piece
 	<p>Schutzgarnitur System GF3, ES3 WK4 mit ZA, ohne Drückerlochteil, Außen: Schild J73, Innen: Schild J71, Vierkant 8mm, Zylinderüberstand in Kern und Kammer 7-12mm mit Knopf J02 72 mm PZ, Türstärke 38-50mm</p> <p><i>Security Set system GF3, ES3 WK4</i> <i>with cylinder protection cover,</i> <i>without lever, exterior: plate J73,</i> <i>interior: plate J71, spindle 8mm,</i> <i>for protruding cylinders from</i> <i>7-12mm with external knob J02</i> <i>72 mm Euro Profile cylinder, door</i> <i>thickness 38-50</i></p>	Chrom - Polished chrome	351-922-072-000	1A351GF9221305XJA
		Ultra Messing - PVD Gold 	351-922-072-367	1A351GF9221346XJA
		Ultra Mattnickel - PVD Satin inox 	351-922-072-066	1A351GF9221398XJA

351GF922	Bezeichnung - Description	Farbe - Finishes	Alte art. nr - Old code	1 Stück - Piece
 	<p>Schutzgarnitur System GF3, ES3 WK4 mit ZA, ohne Drückerlochteil, Außen: Schild J73, Innen: Schild J71, Vierkant 10mm, Zylinderüberstand in Kern und Kammer 7-12mm mit Knopf J02 92 mm PZ, Türstärke 68-82mm</p> <p><i>Security Set system GF3, ES3 WK4</i> <i>with cylinder protection cover,</i> <i>without lever, exterior: plate J73,</i> <i>interior: plate J71, spindle 10mm,</i> <i>for protruding cylinders from</i> <i>7-12mm with external knob J02</i> <i>92 mm Euro Profile cylinder, door</i> <i>thickness 68-82</i></p>	Chrom - Polished chrome	351-922-092-000	1A351GF9221505XJA
		Ultra Messing - PVD Gold 	351-922-092-367	1A351GF9221546XJA
		Ultra Mattnickel - PVD Satin inox 	351-922-092-066	1A351GF9221598XJA

361 GF 420

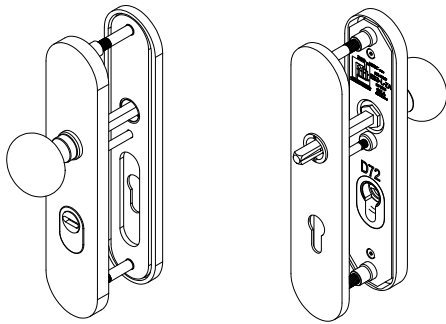

05
Chrom
Polished chrome

46
Ultra Messing
PVD Gold

18
Schwarz RAL 9005
Matt black RAL 9005

PASSENDE TÜRGRIFFE SUITABLE DOOR HANDLES

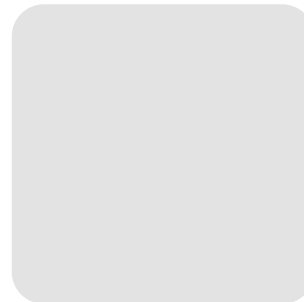
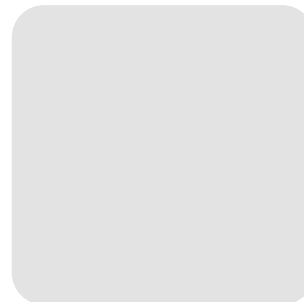
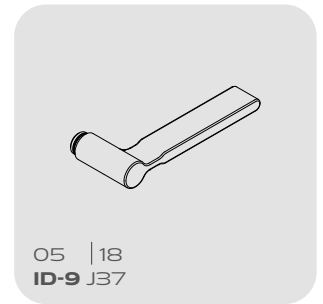
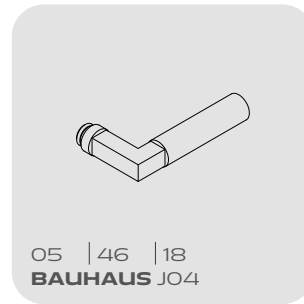

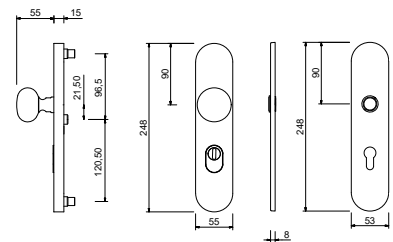

Zubehör für abweichende Türstärken finden Sie ab Seite 236-253

Accessories for different door thicknesses starting from page 236-253

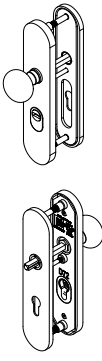

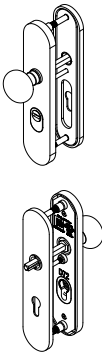
361GF420	Bezeichnung - Description	Farbe - Finishes	Alte art. nr - Old code	1 Stück - Piece
 	<p>Schutzgarnitur System GF3, ES3 WK4 mit ZA, ohne Drückerlochteil, Außen: Schild J63, Innen: Schild J71, linkszeigend, Vierkant 8mm, Zylinderüberstand in Kern und Kammer 7-12mm mit Knopf J01 72 mm PZ, Türstärke 38-50mm</p> <p><i>Security Set system GF3, ES3 WK4 with cylinder protection cover, without lever, exterior: plate J63, interior: plate J71, spindle 8mm, for protruding cylinders from 7-12mm with external knob J01 72 mm Euro Profile cylinder, door thickness 38-50</i></p>	Chrom - Polished chrome	361-420-072-000	1A361GF4201305XJA
		Schwarz RAL 9005 - Matt black RAL 9005	361-420-072-180	1A361GF4201318XJA
		Ultra Messing - PVD Gold 	361-420-072-367	1A361GF4201346XJA

361GF420	Bezeichnung - Description	Farbe - Finishes	Alte art. nr - Old code	1 Stück - Piece
 	<p>Schutzgarnitur System GF3, ES3 WK4 mit ZA, ohne Drückerlochteil, Außen: Schild J63, Innen: Schild J71, linkszeigend, Vierkant 10mm, Zylinderüberstand in Kern und Kammer 7-12mm mit Knopf J01 92 mm PZ, Türstärke 68-82mm</p> <p><i>Security Set system GF3, ES3 WK4 with cylinder protection cover, without lever, exterior: plate J63, interior: plate J71, spindle 10mm, for protruding cylinders from 7-12mm with external knob J01 92 mm Euro Profile cylinder, door thickness 68-82</i></p>	Chrom - Polished chrome	361-420-092-000	1A361GF4201505XJA
		Schwarz RAL 9005 - Matt black RAL 9005	361-420-092-180	1A361GF4201518XJA
		Ultra Messing - PVD Gold 	361-420-092-367	1A361GF4201546XJA

371 GF 373



PASSENDE TÜRGRIFFE SUITABLE DOOR HANDLES

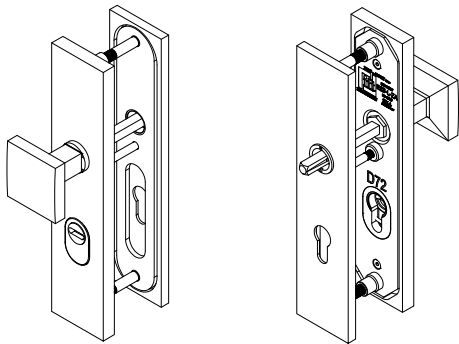

05
Chrom
Polished chrome

18
Schwarz RAL 9005
Matt black RAL 9005

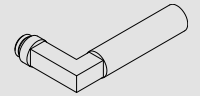

05 | 18
BAUHAUS J04

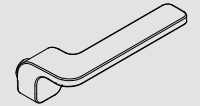

05 | 18
FLUX J20



05 | 18
IQ-CARRE J27

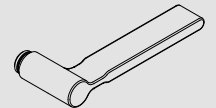

05 | 18
ID-9 J37



05 | 18
PURE J26

Zubehör für abweichende Türstärken finden Sie ab Seite 236-253

Accessories for different door thicknesses starting from page 236-253

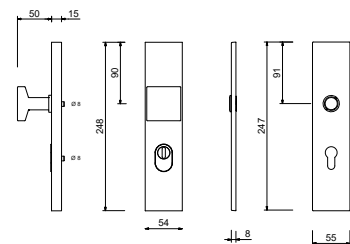

371GF373	Bezeichnung - Description	Farbe - Finishes	Alte art. nr - Old code	1 Stück - Piece
 	<p> Schutzgarnitur System GF3, ES3 WK4 mit ZA, ohne Drückerlochteil, Außen: Schild J53, Innen: Schild J51, Vierkant 8mm, Zylinderüberstand in Kern und Kammer 7-12mm mit Knopf J03 72 mm PZ, Türstärke 38-50mm </p> <p> <i>Security Set system GF3, ES3 WK4 with cylinder protection cover, without lever, exterior: plate J53, interior: plate J51, spindle 8mm, for protruding cylinders from 7-12mm with external knob J03 72 mm Euro Profile cylinder, door thickness 38-50</i> </p>	<p>Chrom - Polished chrome</p> <p>Schwarz RAL 9005 - Matt black RAL 9005</p>	<p>371-373-072-000</p> <p>371-373-072-180</p>	<p>1A371GF3731305XJA</p> <p>1A371GF3731318XJA</p>

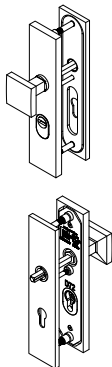
371GF373	Bezeichnung - Description	Farbe - Finishes	Alte art. nr - Old code	1 Stück - Piece
 	<p> Schutzgarnitur System GF3, ES3 WK4 mit ZA, ohne Drückerlochteil, Außen: Schild J53, Innen: Schild J51, Vierkant 10mm, Zylinderüberstand in Kern und Kammer 7-12mm mit Knopf J03 92 mm PZ, Türstärke 68-82mm </p> <p> <i>Security Set system GF3, ES3 WK4 with cylinder protection cover, without lever, exterior: plate J53, interior: plate J51, spindle 10mm, for protruding cylinders from 7-12mm with external knob J03 92 mm Euro Profile cylinder, door thickness 68-82</i> </p>	<p>Chrom - Polished chrome</p> <p>Schwarz RAL 9005 - Matt black RAL 9005</p>	<p>371-373-092-000</p> <p>371-373-092-180</p>	<p>1A371GF3731505XJA</p> <p>1A371GF3731518XJA</p>

371 GF 374

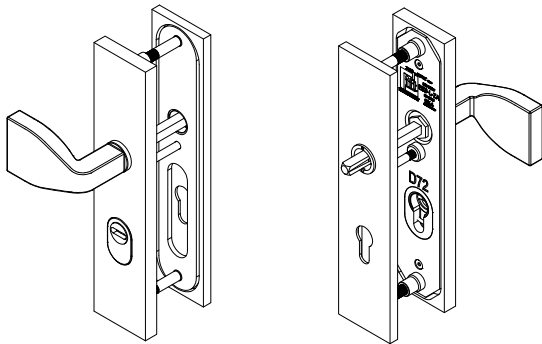

05
Chrom
Polished chrome

18
Schwarz RAL 9005
Matt black RAL 9005

PASSENDE TÜRGRIFFE SUITABLE DOOR HANDLES

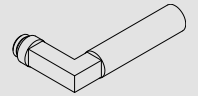

05 | 18
BAUHAUS J04

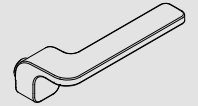

05 | 18
FLUX J20



05 | 18
IQ-CARRE J27

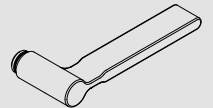

05 | 18
ID-9 J37





05 | 18
PURE J26

Zubehör für abweichende Türstärken finden Sie ab Seite 236-253

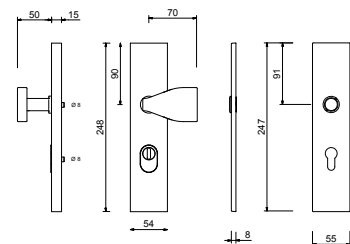
Accessories for different door thicknesses starting from page 236-253

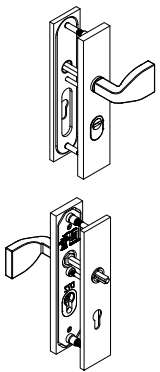

371GF374	Bezeichnung - Description	Farbe - Finishes	Alte art. nr - Old code	1 Stück - Piece
 	<p>Schutzgarnitur System GF3, ES3 WK4 mit ZA, ohne Drückerlochteil, Außen: Schild J53, Innen: Schild J51, Vierkant 8mm, Zylinderüberstand in Kern und Kammer 7-12mm mit Knopf J05 72 mm PZ, Türstärke 38-50mm (rechtszeigend Knopf / DIN links)</p> <p><i>Security Set system GF3, ES3 WK4 with cylinder protection cover, without lever, exterior: plate J53, interior: plate J51, spindle 8mm, for protruding cylinders from 7-12mm with external knob J05 72 mm Euro Profile cylinder, door thickness 38-50 (right knob / DIN left)</i></p>	<p>Chrom - Polished chrome Schwarz RAL 9005 - Matt black RAL 9005</p>	<p>371-374-572-000 371-374-572-180</p>	<p>1A371GF3741305DJA 1A371GF3741318DJA</p>

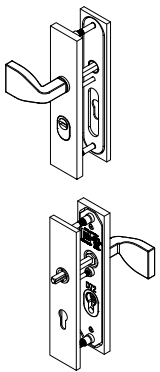
 	<p>Schutzgarnitur System GF3, ES3 WK4 mit ZA, ohne Drückerlochteil, Außen: Schild J53, Innen: Schild J51, Vierkant 8mm, Zylinderüberstand in Kern und Kammer 7-12mm mit Knopf J05 72 mm PZ, Türstärke 38-50mm (linkszeigend Knopf / DIN rechts)</p> <p><i>Security Set system GF3, ES3 WK4 with cylinder protection cover, without lever, exterior: plate J53, interior: plate J51, spindle 8mm, for protruding cylinders from 7-12mm with external knob J05 72 mm Euro Profile cylinder, door thickness 38-50 (left knob / DIN right)</i></p>	<p>Chrom - Polished chrome Schwarz RAL 9005 - Matt black RAL 9005</p>	<p>371-374-472-000 371-374-472-180</p>	<p>1A371GF3741305SJA 1A371GF3741318SJA</p>
---	---	---	--	--

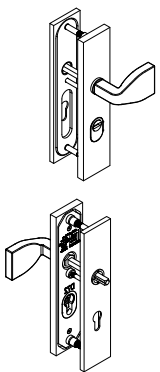
371GF374	Bezeichnung - Description	Farbe - Finishes	Alte art. nr - Old code	1 Stück - Piece
 	<p>Schutzgarnitur System GF3, ES3 WK4 mit ZA, ohne Drückerlochteil, Außen: Schild J53, Innen: Schild J51, Vierkant 10mm, Zylinderüberstand in Kern und Kammer 7-12mm mit Knopf J05 92 mm PZ, Türstärke 68-82mm (rechtszeigend Knopf / DIN links)</p> <p><i>Security Set system GF3, ES3 WK4 with cylinder protection cover, without lever, exterior: plate J53, interior: plate J51, spindle 10mm, for protruding cylinders from 7-12mm with external knob J05 92 mm Euro Profile cylinder, door thickness 68-82 (right knob / DIN left)</i></p>	<p>Chrom - Polished chrome Schwarz RAL 9005 - Matt black RAL 9005</p>	<p>371-374-592-000 371-374-592-180</p>	<p>1A371GF3741505DJA 1A371GF3741518DJA</p>

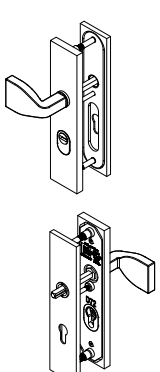
 	<p>Schutzgarnitur System GF3, ES3 WK4 mit ZA, ohne Drückerlochteil, Außen: Schild J53, Innen: Schild J51, Vierkant 10mm, Zylinderüberstand in Kern und Kammer 7-12mm mit Knopf J05 92 mm PZ, Türstärke 68-82mm (linkszeigend Knopf / DIN rechts)</p> <p><i>Security Set system GF3, ES3 WK4 with cylinder protection cover, without lever, exterior: plate J53, interior: plate J51, spindle 10mm, for protruding cylinders from 7-12mm with external knob J05 92 mm Euro Profile cylinder, door thickness 68-82 (left knob / DIN right)</i></p>	<p>Chrom - Polished chrome Schwarz RAL 9005 - Matt black RAL 9005</p>	<p>371-374-492-000 371-374-492-180</p>	<p>1A371GF3741505SJA 1A371GF3741518SJA</p>
--	---	---	--	--

951 GF 913

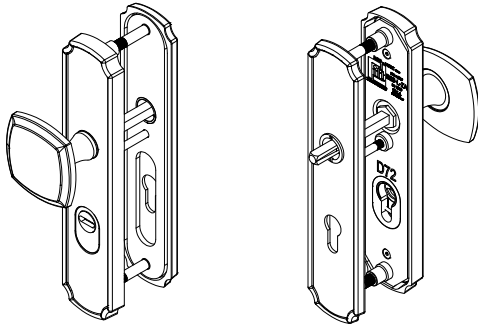

05
Chrom
Polished chrome

98
Ultra Mattnickel
PVD Satin inox

46
Ultra Mattnickel
PVD Gold

PASSENDE TÜRGRIFFE SUITABLE DOOR HANDLES

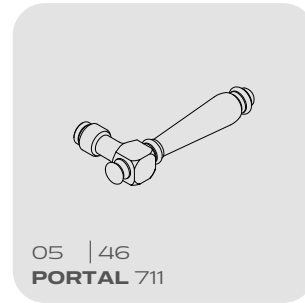
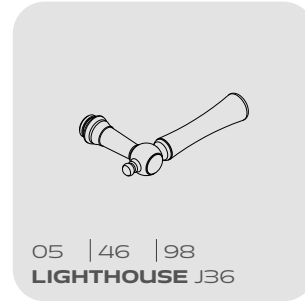
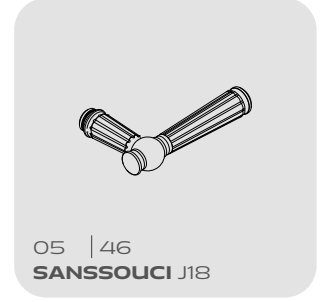

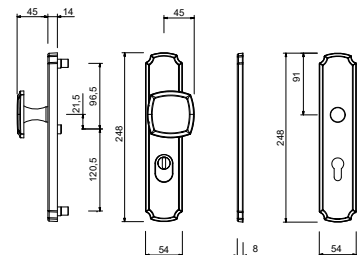

Zubehör für abweichende Türstärken finden Sie ab Seite 236-253

Accessories for different door thicknesses starting from page 236-253

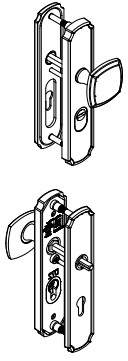

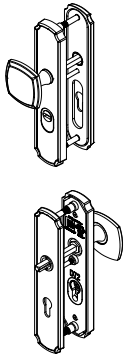
951GF913	Bezeichnung - Description	Farbe - Finishes	Alte art. nr - Old code	1 Stück - Piece
 	<p>Schutzgarnitur System GF3, ES3 WK4 mit ZA, ohne Drückerlochteil, Außen: Schild J57, Innen: Schild J56, Vierkant 8mm, Zylinderüberstand in Kern und Kammer 7-12mm mit Knopf J06 72 mm PZ, Türstärke 38-50mm (rechtszeigend Knopf / DIN links)</p> <p><i>Security Set system GF3, ES3 WK4 with cylinder protection cover, without lever, exterior: plate J57, interior: plate J56, spindle 8mm, for protruding cylinders from 7-12mm with external knob J06 72 mm Euro Profile cylinder, door thickness 38-50 (right knob / DIN left)</i></p>	Chrom - Polished chrome	951-913-572-000	1A951GF9131305DJA
		Ultra Messing - PVD Gold	951-913-572-367	1A951GF9131346DJA
		Ultra Mattnickel - PVD Satin inox	951-913-572-066	1A951GF9131398DJA

 	<p>Schutzgarnitur System GF3, ES3 WK4 mit ZA, ohne Drückerlochteil, Außen: Schild J57, Innen: Schild J56, Vierkant 8mm, Zylinderüberstand in Kern und Kammer 7-12mm mit Knopf J06 72 mm PZ, Türstärke 38-50mm (linkszeigend Knopf / DIN rechts)</p> <p><i>Security Set system GF3, ES3 WK4 with cylinder protection cover, without lever, exterior: plate J57, interior: plate J56, spindle 8mm, for protruding cylinders from 7-12mm with external knob J06 72 mm Euro Profile cylinder, door thickness 38-50 (left knob / DIN right)</i></p>	Chrom - Polished chrome	951-913-472-000	1A951GF9131305SJA
		Ultra Messing - PVD Gold	951-913-472-367	1A951GF9131346SJA
		Ultra Mattnickel - PVD Satin inox	951-913-472-066	1A951GF9131398SJA

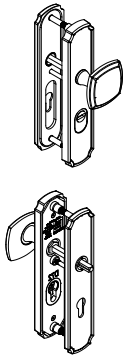
951GF913	Bezeichnung - Description	Farbe - Finishes	Alte art. nr - Old code	1 Stück - Piece
 	<p>Schutzgarnitur System GF3, ES3 WK4 mit ZA, ohne Drückerlochteil, Außen: Schild J57, Innen: Schild J56, Vierkant 10mm, Zylinderüberstand in Kern und Kammer 7-12mm mit Knopf J06 92 mm PZ, Türstärke 68-82mm (rechtszeigend Knopf / DIN links)</p> <p><i>Security Set system GF3, ES3 WK4 with cylinder protection cover, without lever, exterior: plate J57, interior: plate J56, spindle 10mm, for protruding cylinders from 7-12mm with external knob J06 92 mm Euro Profile cylinder, door thickness 68-82 (right knob / DIN left)</i></p>	Chrom - Polished chrome	951-913-592-000	1A951GF9131505DJA
		Ultra Messing - PVD Gold	951-913-592-367	1A951GF9131546DJA
		Ultra Mattnickel - PVD Satin inox	951-913-592-066	1A951GF9131598DJA

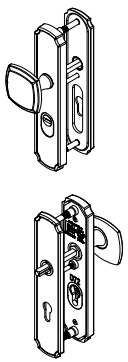
 	<p>Schutzgarnitur System GF3, ES3 WK4 mit ZA, ohne Drückerlochteil, Außen: Schild J57, Innen: Schild J56, Vierkant 10mm, Zylinderüberstand in Kern und Kammer 7-12mm mit Knopf J06 92 mm PZ, Türstärke 68-82mm (linkszeigend Knopf / DIN rechts)</p> <p><i>Security Set system GF3, ES3 WK4 with cylinder protection cover, without lever, exterior: plate J57, interior: plate J56, spindle 10mm, for protruding cylinders from 7-12mm with external knob J06 92 mm Euro Profile cylinder, door thickness 68-82 (left knob / DIN right)</i></p>	Chrom - Polished chrome	951-913-492-000	1A951GF9131505SJA
		Ultra Messing - PVD Gold	951-913-492-367	1A951GF9131546SJA
		Ultra Mattnickel - PVD Satin inox	951-913-492-066	1A951GF9131598SJA

354 AC 420

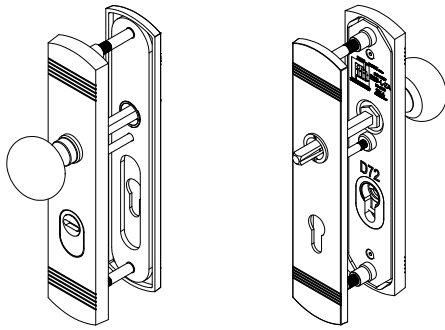

05
Chrom
Polished chrome

46
Ultra Mattnickel
PVD Gold

1M
Messing Rustik
Rustic brass

98
Ultra Mattnickel
PVD Satin inox

PASSENDE TÜRGRIFFE SUITABLE DOOR HANDLES

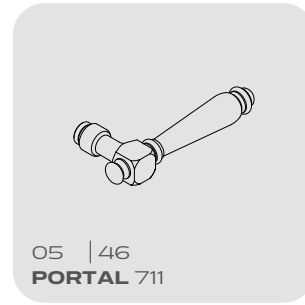
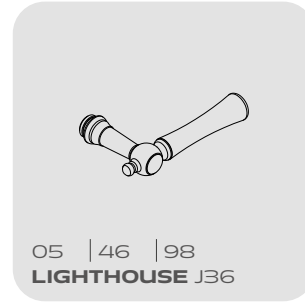
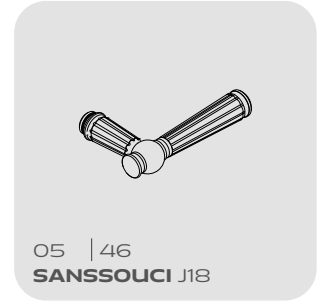
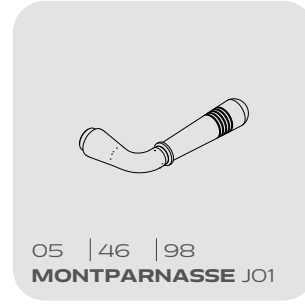
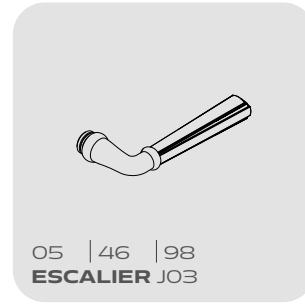

Zubehör für abweichende Türstärken finden Sie ab Seite 236-253

Accessories for different door thicknesses starting from page 236-253

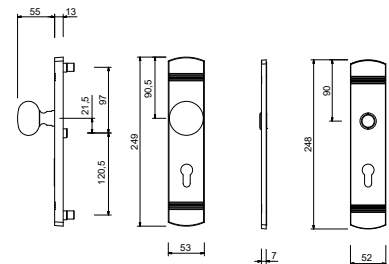

354AC420	Bezeichnung - Description	Farbe - Finishes	Alte art. nr - Old code	1 Stück - Piece
 	<p>Schutzgarnitur System AC3, ES3 WK4 ohne ZA, ohne Drückerlochteil, Außen: Schild J73, Innen: Schild J71, Vierkant 8mm mit Knopf J01 72 mm PZ, Türstärke 38-52mm</p> <p><i>Security Set system AC3, ES3 WK4 without cylinder protection cover, without lever, exterior: plate J73, interior: plate J71, spindle 8mm with external knob J01 72 mm Euro Profile cylinder, door thickness 38-52mm</i></p>	Chrom - Polished chrome	354-420-072-000	1A354AC4201305XJA
		Messing Rustik - Rustic brass	354-420-072-01M	1A354AC420131MXJA
		Ultra Messing - PVD Gold 	354-420-072-367	1A354AC4201346XJA
		Ultra Mattnickel - PVD Satin inox 	354-420-072-066	1A354AC4201398XJA

354AC420	Bezeichnung - Description	Farbe - Finishes	Alte art. nr - Old code	1 Stück - Piece
 	<p>Schutzgarnitur System AC3, ES3 WK4 ohne ZA, ohne Drückerlochteil, Außen: Schild J73, Innen: Schild J71, Vierkant 10mm mit Knopf J01 92 mm PZ, Türstärke 68-82mm</p> <p><i>Security Set system AC3, ES3 WK4 without cylinder protection cover, without lever, exterior: plate J73, interior: plate J71, spindle 10mm with external knob J01 92 mm Euro Profile cylinder, door thickness 68-82mm</i></p>	Chrom - Polished chrome	354-420-092-000	1A354AC4201505XJA
		Messing Rustik - Rustic brass	354-420-092-01M	1A354AC420151MXJA
		Ultra Messing - PVD Gold 	354-420-092-367	1A354AC4201546XJA
		Ultra Mattnickel - PVD Satin inox 	354-420-092-066	1A354AC4201598XJA

354 AC 421

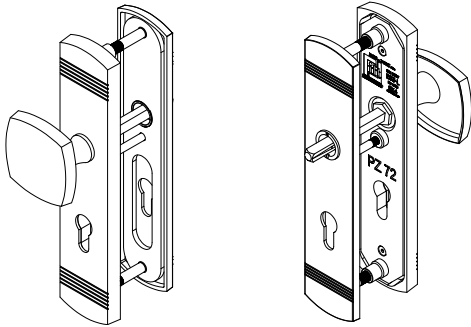

05
Chrom
Polished chrome

46
Ultra Mattnickel
PVD Gold

1M
Messing Rustik
Rustic brass

98
Ultra Mattnickel
PVD Satin inox

PASSENDE TÜRGRIFFE SUITABLE DOOR HANDLES

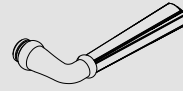

05 | 46 | 98
ESCALIER J03

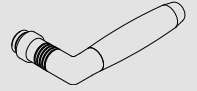

L6 | 6P
METROPOL HOLZ J35

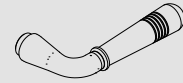

05 | 46 | 98
MONTPARNASSE J01

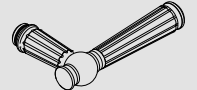

05 | 46
SANSSOUCI J18

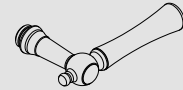

05 | 46 | 98
LIGHTHOUSE J36



05 | 46 | 1M
SCHÖNBRUNN J14

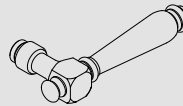

05 | 46
PORTAL 711



Zubehör für abweichende Türstärken finden Sie ab Seite 236-253

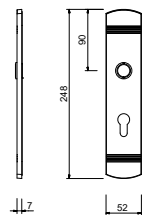
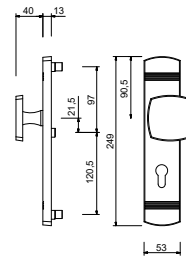

Accessories for different door thicknesses starting from page 236-253

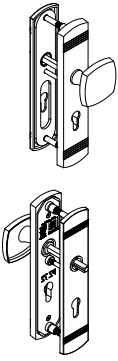

354AC421	Bezeichnung - Description	Farbe - Finishes	Alte art. nr - Old code	1 Stück - Piece
 	<p>Schutzgarnitur System AC3, ES3 WK4 ohne ZA, ohne Drückerlochteil, Außen: Schild J73, Innen: Schild J71, Vierkant 8mm mit Knopf J07 72 mm PZ, Türstärke 38-52mm (rechtszeigend Knopf / DIN links)</p> <p><i>Security Set system AC3, ES3 WK4 without cylinder protection cover, without lever, exterior: plate J73, interior: plate J71, spindle 8mm with external knob J07 72 mm Euro Profile cylinder, door thickness 38-52 (right knob / DIN left)</i></p>	Chrom - Polished chrome	354-421-572-000	1A354AC4211305DJA
		Messing Rustik - Rustic brass	354-421-572-01M	1A354AC421131MDJA
		Ultra Messing - PVD Gold 	354-421-572-367	1A354AC4211346DJA
		Ultra Mattnickel - PVD Satin inox 	354-421-572-066	1A354AC4211398DJA

 	<p>Schutzgarnitur System AC3, ES3 WK4 ohne ZA, ohne Drückerlochteil, Außen: Schild J73, Innen: Schild J71, Vierkant 8mm mit Knopf J07 72 mm PZ, Türstärke 38-52mm (linkszeigend Knopf / DIN rechts)</p> <p><i>Security Set system AC3, ES3 WK4 without cylinder protection cover, without lever, exterior: plate J73, interior: plate J71, spindle 8mm with external knob J07 72 mm Euro Profile cylinder, door thickness 38-52 (left knob / DIN right)</i></p>	Chrom - Polished chrome	354-421-472-000	1A354AC4211305SJA
		Messing Rustik - Rustic brass	354-421-472-01M	1A354AC421131MSJA
		Ultra Messing - PVD Gold 	354-421-472-367	1A354AC4211346SJA
		Ultra Mattnickel - PVD Satin inox 	354-421-472-066	1A354AC4211398SJA

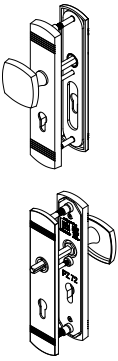
354AC421	Bezeichnung - Description	Farbe - Finishes	Alte art. nr - Old code	1 Stück - Piece
 	<p>Schutzgarnitur System AC3, ES3 WK4 ohne ZA, ohne Drückerlochteil, Außen: Schild J73, Innen: Schild J71, Vierkant 10mm mit Knopf J07 92 mm PZ, Türstärke 68-82mm (rechtszeigend Knopf / DIN links)</p> <p><i>Security Set system AC3, ES3 WK4 without cylinder protection cover, without lever, exterior: plate J73, interior: plate J71, spindle 10mm with external knob J07 92 mm Euro Profile cylinder, door thickness 68-82 (right knob / DIN left)</i></p>	Chrom - Polished chrome	354-421-592-000	1A354AC4211505DJA
		Messing Rustik - Rustic brass	354-421-592-01M	1A354AC421151MDJA
		Ultra Messing - PVD Gold 	354-421-592-367	1A354AC4211546DJA
		Ultra Mattnickel - PVD Satin inox 	354-421-592-066	1A354AC4211598DJA

 	<p>Schutzgarnitur System AC3, ES3 WK4 ohne ZA, ohne Drückerlochteil, Außen: Schild J73, Innen: Schild J71, Vierkant 10mm mit Knopf J07 92 mm PZ, Türstärke 68-82mm (linkszeigend Knopf / DIN rechts)</p> <p><i>Security Set system AC3, ES3 WK4 without cylinder protection cover, without lever, exterior: plate J73, interior: plate J71, spindle 10mm with external knob J07 92 mm Euro Profile cylinder, door thickness 68-82 (left knob / DIN right)</i></p>	Chrom - Polished chrome	354-421-492-000	1A354AC4211505SJA
		Messing Rustik - Rustic brass	354-421-492-01M	1A354AC421151MSJA
		Ultra Messing - PVD Gold 	354-421-492-367	1A354AC4211546SJA
		Ultra Mattnickel - PVD Satin inox 	354-421-492-066	1A354AC4211598SJA

370 AC 374

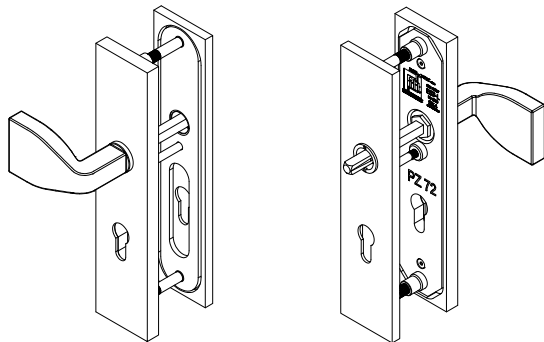

05
Chrom
Polished chrome

98
Ultra Mattnickel
PVD Satin inox

PASSENDE TÜRGRIFFE SUITABLE DOOR HANDLES

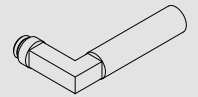

05 | 98
BAUHAUS J04



05
IQ-CARRE J27

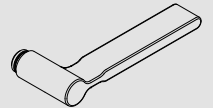

05
ID-9 J37







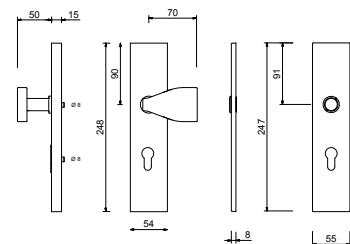

05
PURE J26

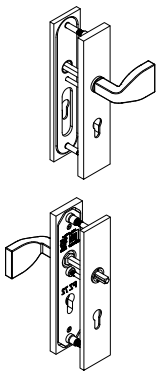
Zubehör für abweichende Türstärken finden Sie ab Seite 236-253

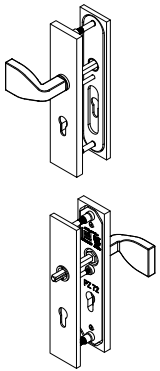
Accessories for different door thicknesses starting from page 236-253

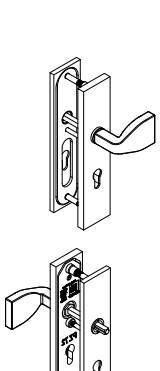

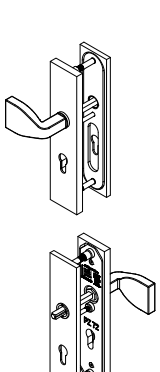
370AC374	Bezeichnung - Description	Farbe - Finishes	Alte art. nr - Old code	1 Stück - Piece
 	<p>Schutzgarnitur System AC3, ES3 WK4 ohne ZA, ohne Drückerlochteil, Außen: Schild J53, Innen: Schild J51, Vierkant 8mm mit Knopf J05 72 mm PZ, Türstärke 38-52mm (rechtszeigend Knopf / DIN links)</p> <p><i>Security Set system AC3, ES3 WK4 without cylinder protection cover, without lever, exterior: plate J53, interior: plate J51, spindle 8mm with external knob J05 72 mm Euro Profile cylinder, door thickness 38-52 (right knob / DIN left)</i></p>	<p>Chrom - Polished chrome Ultra Mattnickel - PVD Satin inox</p>	<p>370-374-572-000 370-374-572-066</p>	<p>1A370AC3741305DJA 1A370AC3741398DJA</p>
 	<p>Schutzgarnitur System AC3, ES3 WK4 ohne ZA, ohne Drückerlochteil, Außen: Schild J53, Innen: Schild J51, Vierkant 8mm mit Knopf J05 72 mm PZ, Türstärke 38-52mm (linkszeigend Knopf / DIN rechts)</p> <p><i>Security Set system AC3, ES3 WK4 without cylinder protection cover, without lever, exterior: plate J53, interior: plate J51, spindle 8mm with external knob J05 72 mm Euro Profile cylinder, door thickness 38-52 (left knob / DIN right)</i></p>	<p>Chrom - Polished chrome Ultra Mattnickel - PVD Satin inox</p>	<p>370-374-472-000 370-374-472-066</p>	<p>1A370AC3741305SJA 1A370AC3741398SJA</p>
 	<p>Schutzgarnitur System AC3, ES3 WK4 ohne ZA, ohne Drückerlochteil, Außen: Schild J53, Innen: Schild J51, Vierkant 10mm mit Knopf J05 92 mm PZ, Türstärke 68-82mm (rechtszeigend Knopf / DIN links)</p> <p><i>Security Set system AC3, ES3 WK4 without cylinder protection cover, without lever, exterior: plate J53, interior: plate J51, spindle 10mm with external knob J05 92 mm Euro Profile cylinder, door thickness 68-82 (right knob / DIN left)</i></p>	<p>Chrom - Polished chrome Ultra Mattnickel - PVD Satin inox</p>	<p>370-374-592-000 370-374-592-066</p>	<p>1A370AC3741505DJA 1A370AC3741598DJA</p>
 	<p>Schutzgarnitur System AC3, ES3 WK4 ohne ZA, ohne Drückerlochteil, Außen: Schild J53, Innen: Schild J51, Vierkant 10mm mit Knopf J05 92 mm PZ, Türstärke 68-82mm (linkszeigend Knopf / DIN rechts)</p> <p><i>Security Set system AC3, ES3 WK4 without cylinder protection cover, without lever, exterior: plate J53, interior: plate J51, spindle 10mm with external knob J05 92 mm Euro Profile cylinder, door thickness 68-82 (left knob / DIN right)</i></p>	<p>Chrom - Polished chrome Ultra Mattnickel - PVD Satin inox</p>	<p>370-374-492-000 370-374-492-066</p>	<p>1A370AC3741505SJA 1A370AC3741598SJA</p>

950 AC 420

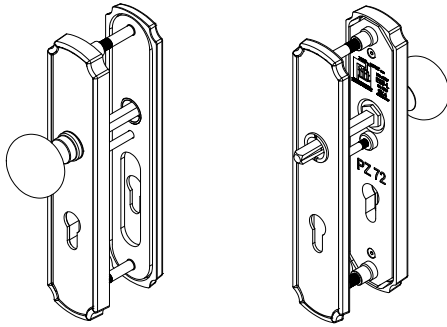

05
Chrom
Polished chrome



46
Ultra Mattnickel
PVD Gold

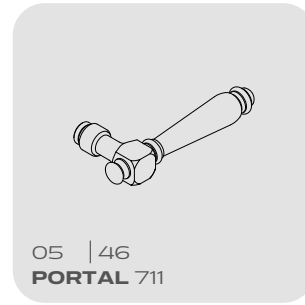
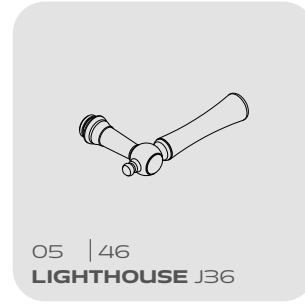
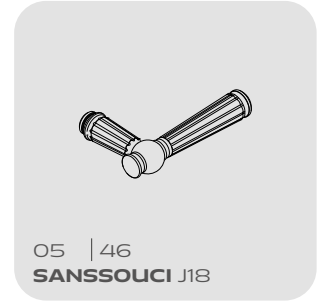

PASSENDE TÜRGRIFFE SUITABLE DOOR HANDLES



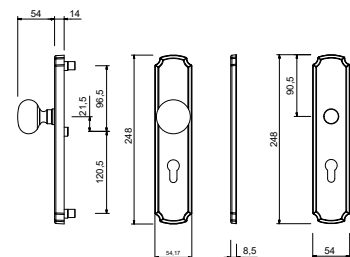

Zubehör für abweichende Türstärken finden Sie ab Seite 236-253

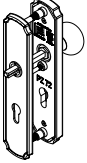
Accessories for different door thicknesses starting from page 236-253

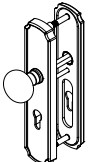
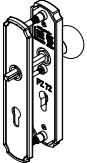

950AC420	Bezeichnung - Description	Farbe - Finishes	Alte art. nr - Old code	1 Stück - Piece
  	<p>Schutzgarnitur System AC3, ES3 WK4 ohne ZA, ohne Drückerlochteil, Außen: Schild J57, Innen: Schild J56, Vierkant 8mm mit Knopf J01 72 mm PZ, Türstärke 38-52mm</p> <p>Security Set system AC3, ES3 WK4 without cylinder protection cover, without lever, exterior: plate J57, interior: plate J56, spindle 8mm with external knob J01 72 mm Euro Profile cylinder, door thickness 38-52mm</p>	Chrom - Polished chrome	950-420-072-000	1A950AC4201305XJA
		Ultra Messing - PVD Gold 	950-420-072-367	1A950AC4201346XJA

950AC420	Bezeichnung - Description	Farbe - Finishes	Alte art. nr - Old code	1 Stück - Piece
  	<p>Schutzgarnitur System AC3, ES3 WK4 ohne ZA, ohne Drückerlochteil, Außen: Schild J57, Innen: Schild J56, Vierkant 10mm mit Knopf J01 92 mm PZ, Türstärke 68-82mm</p> <p>Security Set system AC3, ES3 WK4 without cylinder protection cover, without lever, exterior: plate J57, interior: plate J56, spindle 10mm with external knob J01 92 mm Euro Profile cylinder, door thickness 68-82mm</p>	Chrom - Polished chrome	950-420-092-000	1A950AC4201505XJA
		Ultra Messing - PVD Gold 	950-420-092-367	1A950AC4201546XJA

950 AC 913

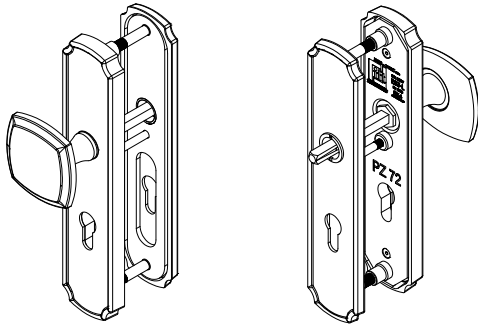

05
Chrom
Polished chrome



46
Ultra Mattnickel
PVD Gold

PASSENDE TÜRGRIFFE SUITABLE DOOR HANDLES

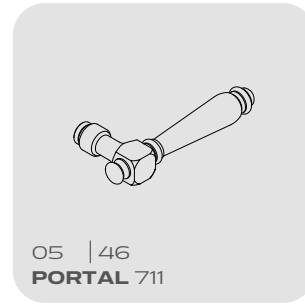
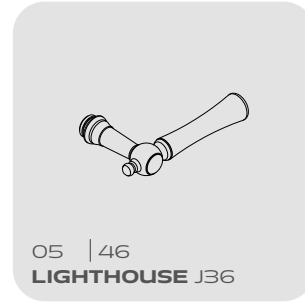



Zubehör für abweichende Türstärken finden Sie ab Seite 236-253

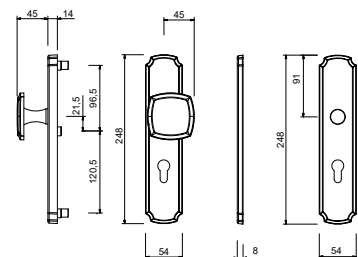

Accessories for different door thicknesses starting from page 236-253

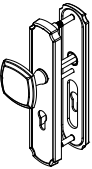

950AC913	Bezeichnung - Description	Farbe - Finishes	Alte art. nr - Old code	1 Stück - Piece
  	<p>Schutzgarnitur System AC3, ES3 WK4 ohne ZA, ohne Drückerlochteil, Außen: Schild J57, Innen: Schild J56, Vierkant 8mm mit Knopf J06 72 mm PZ, Türstärke 38-52mm (rechtszeigend Knopf / DIN links)</p> <p><i>Security Set system AC3, ES3 WK4 without cylinder protection cover, without lever, exterior: plate J57, interior: plate J56, spindle 8mm with external knob J06 72 mm Euro Profile cylinder, door thickness 38-52 (right knob / DIN left)</i></p>	Chrom - Polished chrome	950-913-572-000	1A950AC9131305DJA
		Ultra Messing - PVD Gold 	950-913-572-367	1A950AC9131346DJA

  	<p>Schutzgarnitur System AC3, ES3 WK4 ohne ZA, ohne Drückerlochteil, Außen: Schild J57, Innen: Schild J56, Vierkant 8mm mit Knopf J06 72 mm PZ, Türstärke 38-52mm (linkszeigend Knopf / DIN rechts)</p> <p><i>Security Set system AC3, ES3 WK4 without cylinder protection cover, without lever, exterior: plate J57, interior: plate J56, spindle 8mm with external knob J06 72 mm Euro Profile cylinder, door thickness 38-52 (left knob / DIN right)</i></p>	Chrom - Polished chrome	950-913-472-000	1A950AC9131305SJA
		Ultra Messing - PVD Gold 	950-913-472-367	1A950AC9131346SJA

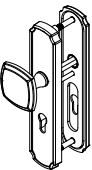
950AC913	Bezeichnung - Description	Farbe - Finishes	Alte art. nr - Old code	1 Stück - Piece
  	<p>Schutzgarnitur System AC3, ES3 WK4 ohne ZA, ohne Drückerlochteil, Außen: Schild J57, Innen: Schild J56, Vierkant 10mm mit Knopf J06 92 mm PZ, Türstärke 68-82mm (rechtszeigend Knopf / DIN links)</p> <p><i>Security Set system AC3, ES3 WK4 without cylinder protection cover, without lever, exterior: plate J57, interior: plate J56, spindle 10mm with external knob J06 92 mm Euro Profile cylinder, door thickness 68-82 (right knob / DIN left)</i></p>	Chrom - Polished chrome	950-913-592-000	1A950AC9131505DJA
		Ultra Messing - PVD Gold 	950-913-592-367	1A950AC9131546DJA

  	<p>Schutzgarnitur System AC3, ES3 WK4 ohne ZA, ohne Drückerlochteil, Außen: Schild J57, Innen: Schild J56, Vierkant 10mm mit Knopf J06 92 mm PZ, Türstärke 68-82mm (linkszeigend Knopf / DIN rechts)</p> <p><i>Security Set system AC3, ES3 WK4 without cylinder protection cover, without lever, exterior: plate J57, interior: plate J56, spindle 10mm with external knob J06 92 mm Euro Profile cylinder, door thickness 68-82 (left knob / DIN right)</i></p>	Chrom - Polished chrome	950-913-492-000	1A950AC9131505SJA
		Ultra Messing - PVD Gold 	950-913-492-367	1A950AC9131546SJA

CD J50



SCHUTZGARNITUREN - SECURITY SET



-  **18**
Schwarz RAL 9005
Matt black RAL 9005
-  **46**
Ultra Mattnickel
PVD Gold
-  **5S**
Edelstahl
Stainless steel 304

000CDJ50	Bezeichnung - Description	Farbe - Finishes	Alte art. nr - Old code	1 Stück - Piece
 	Schutzrosettenpaar 373-855 System GF5, ES1, WK2 mit ZA, Außen: Schutzrosette 373-855, Innen: Schlüsselrosette 373-153, Türstärke 38-50mm, Zylinderüberstand in Kern und Kammer 10-15mm mit PZ Lochung Safety escutcheon ø55mm with euro cylinder protection adjustable and 2 screws door through M5 center to center mm 38-internal steel hardened protection rose Euro profile hole	Schwarz RAL 9005 - Matt black RAL 9005	373-855-500-180	1A000CDJ502Y18XJA
		Ultra Messing - PVD Gold 	373-855-500-367	1A000CDJ502Y46XJA
		Edelstahl - Stainless steel 304	373-855-500-055	1A000CDJ502Y5SXJA

CD JQ5

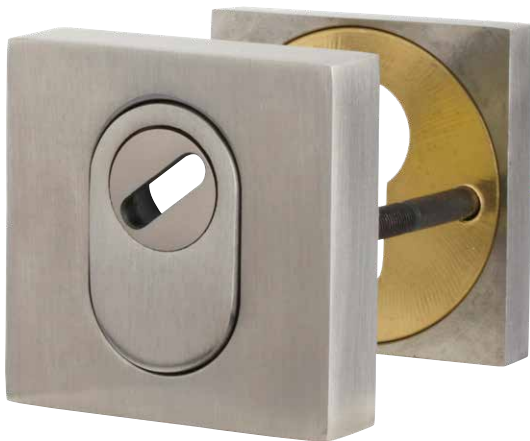

-  **18**
Schwarz RAL 9005
Matt black RAL 9005
-  **5S**
Edelstahl
Stainless steel 304

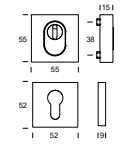
000CDJQ5	Bezeichnung - Description	Farbe - Finishes	Alte art. nr - Old code	1 Stück - Piece
 	Schutzrosettenpaar 371-855 System GF5, ES1, WK2 mit ZA, Außen: Schutzrosette 371-855, Innen: Schlüsselrosette 371-153, Türstärke 38-50mm, Zylinderüberstand in Kern und Kammer 10-15mm mit PZ Lochung Security rosettes with cylinder protection cover, exterior: security rosette 371-855, interior: key rosette 371-153, door thickness 38-50mm, for protruding cylinders from 10-15mm Euro profile hole	Schwarz RAL 9005 - Matt black RAL 9005	371-855-500-180	1A000CDJQ52Y18XJA
		Edelstahl - Stainless steel 304	371-855-500-055	1A000CDJQ52Y5SXJA

J50 BY



SCHUTZGARNITUREN - SECURITY SET



- 18**
Schwarz RAL 9005
Matt black RAL 9005
- 46**
Ultra Mattnickel
PVD Gold
- 5S**
Edelstahl
Stainless steel 304

J50BYXXX	Bezeichnung - Description	Farbe - Finishes	Alte art. nr - Old code	1 Stück - Piece
 	Schutzrosette nur Außenseite mit KZS Ø55mm Höhe 15mm mit Schrauben <i>External escutcheon (euro profile cylinder hole) with cylinder cover, height 15 mm with screws</i>	Schwarz RAL 9005 - Matt black RAL 9005	373-855-200-180	1AJ50BYXXXXX18XJA
		Ultra Messing - PVD Gold	373-855-200-367	1AJ50BYXXXXX46XJA
		Edelstahl - Stainless steel 304	373-855-200-055	1AJ50BYXXXXX5SXJA

JQ5 BY



- 18**
Schwarz RAL 9005
Matt black RAL 9005
- 5S**
Edelstahl
Stainless steel 304

JQ5BYXXX	Bezeichnung - Description	Farbe - Finishes	Alte art. nr - Old code	1 Stück - Piece
 	Schutzrosette nur Außenseite mit KZS 55x55mm Höhe 15mm mit Schrauben <i>External escutcheon (euro profile cylinder key hole) with cylinder cover, height 15 mm with screws</i>	Schwarz RAL 9005 - Matt black RAL 9005	371-855-200-180	1AJQ5BYXXXXX18XJA
		Edelstahl - Stainless steel 304	371-855-200-055	1AJQ5BYXXXXX5SXJA



J01 PL



J01PLXXX

Bezeichnung - Description

Farbe - Finishes

Alte art. nr - Old code

1 Stück - Piece

Knopf ungebohrt Ø50 mm mit M12 Gewinde

Knob only Ø50 mm with thread M12

Chrom - Polished chrome	420-508-000-000	1AJ01PLXXX1205XJA
Schwarz RAL 9005 - Matt black RAL 9005	420-508-000-180	1AJ01PLXXX1218XJA
Messing Rustik - Rustic brass	420-508-000-01M	1AJ01PLXXX121MXJA
Ultra Messing - PVD Gold	420-508-000-367	1AJ01PLXXX1246XJA
Ultra Mattnickel - PVD Satin inox	420-508-000-066	1AJ01PLXXX1298XJA

1 50 I

50

1 55 I

50

J02 PL

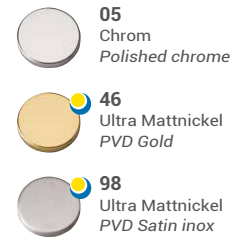

J02PLXXX

Bezeichnung - Description

Farbe - Finishes

Alte art. nr - Old code

1 Stück - Piece

Knopf ungebohrt Ø50 mm mit M12 Gewinde

Knob only Ø50 mm with thread M12

Chrom - Polished chrome	922-508-000-000	1AJ02PLXXX1205XJA
Ultra Messing - PVD Gold	922-508-000-367	1AJ02PLXXX1246XJA
Ultra Mattnickel - PVD Satin inox	922-508-000-066	1AJ02PLXXX1298XJA

1 50 I

50



129I

50

121I

J03 PL



-  **05**
Chrom
Polished chrome
-  **18**
Schwarz RAL 9005
Matt black RAL 9005
-  **98**
Ultra Mattnickel
PVD Satin inox

J03PLXXX	Bezeichnung - Description	Farbe - Finishes	Alte art. nr - Old code	1 Stück - Piece
	Knopf ungebohrt 50x50 mm mit M12 Gewinde <i>Knob only 50x50 mm with thread M12</i>	Chrom - Polished chrome	373-508-000-000	1AJ03PLXXX1205XJA
		Schwarz RAL 9005 - Matt black RAL 9005	373-508-000-180	1AJ03PLXXX1218XJA
		Ultra Mattnickel - PVD Satin inox 	373-508-000-066	1AJ03PLXXX1298XJA

J04 PL



-  **5S**
Edelstahl
Stainless steel 304

J04PLXXX	Bezeichnung - Description	Farbe - Finishes	Alte art. nr - Old code	1 Stück - Piece
	Knopf ungebohrt mit M12 Gewinde <i>Offset Knob only with thread M12</i>	Edelstahl - Stainless steel 304	914-050-000-055	1AJ04PLXXX125SXJA

J05 PL



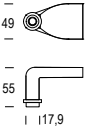

-  **05**
Chrom
Polished chrome
-  **18**
Schwarz RAL 9005
Matt black RAL 9005
-  **46**
Ultra Mattnickel
PVD Gold
-  **98**
Ultra Mattnickel
PVD Satin inox

J05PLXXX	Bezeichnung - Description	Farbe - Finishes	Alte art. nr - Old code	1 Stück - Piece
 <p>Knopf ungebohrt 69x69mm mit M12 Gewinde</p> <p>Knob only 69x69 mm with thread M12</p>	Chrom - Polished chrome	-	1AJ05PLXXX1205XJA	
	Schwarz RAL 9005 - Matt black RAL 9005	374-508-000-180	1AJ05PLXXX1218XJA	
	Ultra Messing - PVD Gold	374-508-000-367	1AJ05PLXXX1246XJA	
	Ultra Mattnickel - PVD Satin inox	-	1AJ05PLXXX1298XJA	



J06 PL



-  **05**
Chrom
Polished chrome
-  **46**
Ultra Mattnickel
PVD Gold
-  **98**
Ultra Mattnickel
PVD Satin inox

J06PLXXX	Bezeichnung - Description	Farbe - Finishes	Alte art. nr - Old code	1 Stück - Piece
 <p>Knopf ungebohrt 69x69mm mit M12 Gewinde</p> <p>Knob only 69x69 mm with thread M12</p>	Chrom - Polished chrome	913-000-000-000	1AJ06PLXXX1205XJA	
	Ultra Messing - PVD Gold	913-000-000-367	1AJ06PLXXX1246XJA	
	Ultra Mattnickel - PVD Satin inox	913-000-000-066	1AJ06PLXXX1298XJA	



- 
05
 Chrom
Polished chrome
- 
46
 Ultra Mattnickel
PVD Gold
- 
98
 Ultra Mattnickel
PVD Satin inox

J07PLXXX	Bezeichnung - Description	Farbe - Finishes	Alte art. nr - Old code	1 Stück - Piece
	 <p>Knopf ungebohrt 67x67mm mit M12 Gewinde</p> <p><i>Offset Knob only 67x67 mm with thread M12</i></p>	Chrom - Polished chrome	421-000-000-000	1AJ07PLXXX1205XJA
		Ultra Messing - PVD Gold	421-000-000-367	1AJ07PLXXX1246XJA
		Ultra Mattnickel - PVD Satin inox	421-000-000-066	1AJ07PLXXX1298XJA

J01 RO

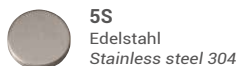

J01ROXXX	Bezeichnung - Description	Farbe - Finishes	Alte art. nr - Old code	1 Stück - Piece
 <p>Rosette Ø52x9 mm für GF1 System Rose Ø52x9 mm for System GF1</p>		Ultra Messing - PVD Gold	373-1X3-000-367	1AJ01ROXXXGF46XJA
		Edelstahl - Stainless steel 304	373-1X3-000-055	1AJ01ROXXXGF5SXJA
		Ultra Mattnickel - PVD Satin inox	373-1X3-000-066	1AJ01ROXXXGF98XJA

J03 RO

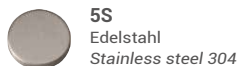

J03ROXXX	Bezeichnung - Description	Farbe - Finishes	Alte art. nr - Old code	1 Stück - Piece	
 <p>Rosette Ø55x9 mm für GF1 System Rose Ø55x9 mm for System GF1</p>		Edelstahl - Stainless steel 304	993-1X3-000-055	1AJ03ROXXXGF5SXJA	

J30 RO

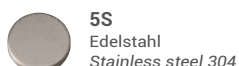
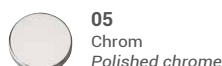

J30ROXXX	Bezeichnung - Description	Farbe - Finishes	Alte art. nr - Old code	1 Stück - Piece
 <p>Rosette 52x52x9 mm für GF1 System Rose 52x52x9 mm for System GF1</p>		Chrom - Polished chrome	371-1X3-000-000	1AJ30ROXXXGF05XJA
		Edelstahl - Stainless steel 304	371-1X3-000-055	1AJ30ROXXXGF5SXJA
		Ultra Mattnickel - PVD Satin inox	371-1X3-000-066	1AJ30ROXXXGF98XJA



J36ROXXX	Bezeichnung - Description	Farbe - Finishes	Alte art. nr - Old code	1 Stück - Piece
 <p>Rosette Ø55x9 mm für GF1 System Rose Ø55x9 mm for System GF1</p>	Ultra Mattnickel - PVD Satin inox	428-1X3-000-066	1AJ36ROXXXGF98XJA	

J01 BY

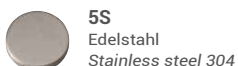

J01BYXXX	Bezeichnung - Description	Farbe - Finishes	Alte art. nr - Old code	1 Stück - Piece
 <p>Schlüsselrosette PZ Ø52x9 mm mit M5 Gewindenocken und Schrauben M5x50 Euro profile escutcheon Ø52x9 mm with M5 threads and screws M5x50</p>	Ultra Messing - PVD Gold	373-1X3-200-367	1AJ01BYXXXGF46XJA	
	Edelstahl - Stainless steel 304	373-1X3-200-055	1AJ01BYXXXGF5SXJA	
	Ultra Mattnickel - PVD Satin inox	373-1X3-200-066	1AJ01BYXXXGF98XJA	

J03 BY

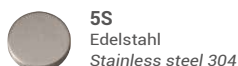

J03BYXXX	Bezeichnung - Description	Farbe - Finishes	Alte art. nr - Old code	1 Stück - Piece
 <p>Schlüsselrosette PZ Ø55x9 mm mit M5 Gewindenocken und Schrauben M5x50 Euro profile escutcheon Ø55x9 mm with M5 threads and screws M5x50</p>	Edelstahl - Stainless steel 304	993-1X3-200-055	1AJ03BYXXXGF5SXJA	

J30 BY

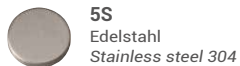

J30BYXXX	Bezeichnung - Description	Farbe - Finishes	Alte art. nr - Old code	1 Stück - Piece
 <p>Schlüsselrosette PZ 52x52x9 mm mit M5 Gewindenocken und Schrauben M5x50</p> <p><i>Euro profile escutcheon 52x52x9 mm with M5 threads and screws M5x50</i></p>		Chrom - Polished chrome	371-1X3-200-000	1AJ30BYXXXGF05XJA
		Edelstahl - Stainless steel 304	371-1X3-200-055	1AJ30BYXXXGF5SXJA
		Ultra Mattnickel - PVD Satin inox	371-1X3-200-066	1AJ30BYXXXGF98XJA

J36 BY



J36BYXXX	Bezeichnung - Description	Farbe - Finishes	Alte art. nr - Old code	1 Stück - Piece
 <p>Schlüsselrosette PZ Ø55x9 mm mit M5 Gewindenocken und Schrauben M5x50</p> <p><i>Euro profile escutcheon Ø55x9 mm with M5 threads and screws M5x50</i></p>		Ultra Mattnickel - PVD Satin inox	428-1X3-200-066	1AJ36BYXXXGF98XJA

J52 KP

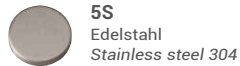

J52KPXXX

Bezeichnung - Description

Farbe - Finishes

Alte art. nr - Old code

1 Stück - Piece

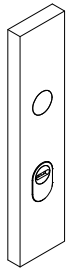

Außenschild System GF1, Höhe 15mm, mit 4 Stütznocken M5 für Rosettenverschraubung, Zylinderüberstand in Kern und Kammer 10-15mm 72mm mit ZA

Exterior plate System GF1, height 15 mm, with 4 support cams M5 for rosette bolting, for protruding cylinders from 10-15mm 72mm with cylinder cover

Chrom - Polished chrome

973-872-200-000

1AJ52KPXXXN205XJA

Edelstahl - Stainless steel 304

973-872-200-055

1AJ52KPXXXN25SXJA

Außenschild System GF1, Höhe 15mm, mit 4 Stütznocken M5 für Rosettenverschraubung, Zylinderüberstand in Kern und Kammer 10-15mm 92mm mit ZA

Exterior plate System GF1, height 15 mm, with 4 support cams M5 for rosette bolting, for protruding cylinders from 10-15mm 92mm with cylinder cover

Chrom - Polished chrome

973-892-200-000

1AJ52KPXXXN505XJA

Edelstahl - Stainless steel 304

973-892-200-055

1AJ52KPXXXN55SXJA



J62 KP

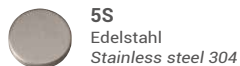

J62KPXXX

Bezeichnung - Description

Farbe - Finishes

Alte art. nr - Old code

1 Stück - Piece



Außenschild System GF1, Höhe 15mm, mit 4 Stütznocken M5 für Rosettenverschraubung, Zylinderüberstand in Kern und Kammer 10-15mm 72mm mit ZA

Exterior plate System GF1, height 15 mm, with 4 support cams M5 for rosette bolting, for protruding cylinders from 10-15mm 72mm with cylinder cover

Ultra Messing - PVD Gold

952-872-200-367

1AJ62KPXXXN246XJA

Edelstahl - Stainless steel 304

952-872-200-055

1AJ62KPXXXN25SXJA

Außenschild System GF1, Höhe 15mm, mit 4 Stütznocken M5 für Rosettenverschraubung, Zylinderüberstand in Kern und Kammer 10-15mm 92mm mit ZA

Exterior plate System GF1, height 15 mm, with 4 support cams M5 for rosette bolting, for protruding cylinders from 10-15mm 92mm with cylinder cover

Ultra Messing - PVD Gold

952-892-200-367

1AJ62KPXXXN546XJA

Edelstahl - Stainless steel 304

952-892-200-055

1AJ62KPXXXN55SXJA



J50 KP

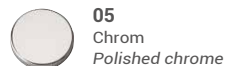

05
Chrom
Polished chrome



46
Ultra Mattnickel
PVD Gold



50
Edelstahl Spiegelpoliert
Polished stainless steel

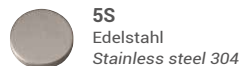

5S
Edelstahl
Stainless steel 304

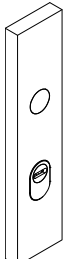
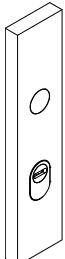
J50KPXXX	Bezeichnung - Description	Farbe - Finishes	Alte art. nr - Old code	1 Stück - Piece
	Außenschild System GF2, Höhe 15mm, mit 1 Stütznocke M6 und 2 Stütznocken M8 für Schildverschraubung, Zylinderüberstand in Kern und Kammer 10-15mm 72mm mit ZA <i>Exterior plate System GF2, height 15 mm, with 1 support cam M6 and 2 support cams M8 for plate bolting, for protruding cylinders from 10-15mm 72mm with cylinder cover</i>	Chrom - Polished chrome	973-X72-200-000	1AJ50KPXXXN205XJA
		Ultra Messing - PVD Gold	973-X72-200-367	1AJ50KPXXXN246XJA
		Edelstahl Spiegelpol. - Polished Stainless Steel	973-X72-200-155	1AJ50KPXXXN250XJA
		Edelstahl - Stainless steel 304	973-X72-200-055	1AJ50KPXXXN25SXJA
	Außenschild System GF2, Höhe 15mm, mit 1 Stütznocke M6 und 2 Stütznocken M8 für Schildverschraubung, Zylinderüberstand in Kern und Kammer 10-15mm 92mm mit ZA <i>Exterior plate System GF2, height 15 mm, with 1 support cam M6 and 2 support cams M8 for plate bolting, for protruding cylinders from 10-15mm 92mm with cylinder cover</i>	Chrom - Polished chrome	973-X92-200-000	1AJ50KPXXXN505XJA
		Ultra Messing - PVD Gold	973-X92-200-367	1AJ50KPXXXN546XJA
		Edelstahl Spiegelpol. - Polished Stainless Steel	973-X92-200-155	1AJ50KPXXXN550XJA
		Edelstahl - Stainless steel 304	973-X92-200-055	1AJ50KPXXXN55SXJA



J60 KP

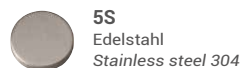

5S
Edelstahl
Stainless steel 304

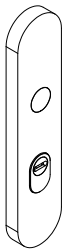
J60KPXXX	Bezeichnung - Description	Farbe - Finishes	Alte art. nr - Old code	1 Stück - Piece
	Außenschild System GF2, Höhe 15mm, 72mm PZ, mit ZA, mit 1 Stütznocke M6 und 2 Stütznocken M8 für Schildverschraubung 72mm mit ZA <i>Exterior plate system GF2, height 15 mm, with 1 support cam M6 and 2 support cams M8 for plate bolting, for protruding cylinders from 10-15mm 72mm with cylinder cover</i>	Edelstahl - Stainless steel 304	952-X72-200-055	1AJ60KPXXXN25SXJA
		Edelstahl - Stainless steel 304	952-X92-200-055	1AJ60KPXXXN55SXJA



J53 KP



J53KPXXX

Bezeichnung - Description

Farbe - Finishes

Alte art. nr - Old code

1 Stück - Piece



Außenschild System GF3, Höhe 13mm, mit 1 Stütznocke M6 und 2 Stütznocken M8 für Schildverschraubung 72mm mit ZA

Exterior plate System GF3, height 13 mm, with 1 support cam M6 and 2 support cams M8 for plate bolting, 72mm with cylinder cover

Chrom - Polished chrome

977-X72-200-000

1AJ53KPXXXN205XJA

Schwarz RAL 9005 - Matt black RAL 9005

977-X72-200-180

1AJ53KPXXXN218XJA

Außenschild System GF3, Höhe 13mm, mit 1 Stütznocke M6 und 2 Stütznocken M8 für Schildverschraubung 92mm mit ZA

Exterior plate System GF3, height 13 mm, with 1 support cam M6 and 2 support cams M8 for plate bolting, 92mm with cylinder cover

Chrom - Polished chrome

977-X92-200-000

1AJ53KPXXXN505XJA

Schwarz RAL 9005 - Matt black RAL 9005

977-X92-200-180

1AJ53KPXXXN518XJA



J57 KP



J57KPXXX

Bezeichnung - Description

Farbe - Finishes

Alte art. nr - Old code

1 Stück - Piece

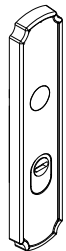

Außenschild System AC3, Höhe 14mm, 72mm PZ, ohne ZA, mit 1 Stütznocke M6 und 2 Stütznocken M8 für Schildverschraubung 72mm mit ZA

Exterior plate System GF3, height 14 mm, 72mm euro profile cylinder key hole, with 1 support cam M6 and 2 support cams M8 for plate bolting 72mm with cylinder cover

Chrom - Polished chrome

956-872-200-000

1AJ57KPXXXN205XJA

Ultra Messing - PVD Gold

956-872-200-367

1AJ57KPXXXN246XJA

Ultra Mattnickel - PVD Satin inox

956-872-200-066

1AJ57KPXXXN298XJA

Außenschild System AC3, Höhe 14mm, 72mm PZ, ohne ZA, mit 1 Stütznocke M6 und 2 Stütznocken M8 für Schildverschraubung 92mm mit ZA

Exterior plate System GF3, height 14 mm, 72mm euro profile cylinder key hole, with 1 support cam M6 and 2 support cams M8 for plate bolting 92mm with cylinder cover

Chrom - Polished chrome

956-892-200-000

1AJ57KPXXXN505XJA

Ultra Messing - PVD Gold

956-892-200-367

1AJ57KPXXXN546XJA

Ultra Mattnickel - PVD Satin inox

956-892-200-066

1AJ57KPXXXN598XJA



J63 KP



05
Chrom
Polished chrome

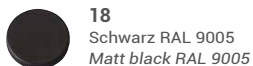

18
Schwarz RAL 9005
Matt black RAL 9005



46
Ultra Mattnickel
PVD Gold

J63KPXXX

Bezeichnung - Description

Farbe - Finishes

Alte art. nr - Old code

1 Stück - Piece

Außenschild System AC3, Höhe 13mm, mit 1 Stütznocke M6 und 2 Stütznocken M8 für Schildverschraubung 72mm mit ZA

Exterior plate System AC3, height 13 mm, with 1 support cam M6 and 2 support cams M8 for plate bolting 72mm with cylinder cover

Chrom - Polished chrome

957-X72-200-000

1AJ63KPXXXN205XJA

Schwarz RAL 9005 - Matt black RAL 9005

957-X72-200-180

1AJ63KPXXXN218XJA

Ultra Messing - PVD Gold

957-X72-200-367

1AJ63KPXXXN246XJA

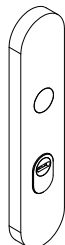

Außenschild System AC3, Höhe 13mm, mit 1 Stütznocke M6 und 2 Stütznocken M8 für Schildverschraubung 92mm mit ZA

Exterior plate System AC3, height 13 mm, with 1 support cam M6 and 2 support cams M8 for plate bolting 92mm with cylinder cover

Chrom - Polished chrome

957-X92-200-000

1AJ63KPXXXN505XJA

Schwarz RAL 9005 - Matt black RAL 9005

957-X92-200-180

1AJ63KPXXXN518XJA

Ultra Messing - PVD Gold

957-X92-200-367

1AJ63KPXXXN546XJA



J73 KP



05
Chrom
Polished chrome



46
Ultra Mattnickel
PVD Gold



98
Ultra Mattnickel
PVD Satin inox

J73KPXXX

Bezeichnung - Description

Farbe - Finishes

Alte art. nr - Old code

1 Stück - Piece

Außenschild System AC3, Höhe 13mm, mit 1 Stütznocke M6 und 2 Stütznocken M8 für Schildverschraubung 72mm mit ZA

Exterior plate System AC3, height 13 mm, with 1 support cam M6 and 2 support cams M8 for plate bolting 72mm with cylinder cover

Chrom - Polished chrome

351-X72-200-000

1AJ73KPXXXN205XJA

Ultra Messing - PVD Gold

351-X72-200-367

1AJ73KPXXXN246XJA

Ultra Mattnickel - PVD Satin inox

351-X72-200-066

1AJ73KPXXXN298XJA



Außenschild System AC3, Höhe 13mm, mit 1 Stütznocke M6 und 2 Stütznocken M8 für Schildverschraubung 92mm mit ZA

Exterior plate System AC3, height 13 mm, with 1 support cam M6 and 2 support cams M8 for plate bolting 92mm with cylinder cover

Chrom - Polished chrome

351-X92-200-000

1AJ73KPXXXN505XJA

Ultra Messing - PVD Gold

351-X92-200-367

1AJ73KPXXXN546XJA

Ultra Mattnickel - PVD Satin inox

351-X92-200-066

1AJ73KPXXXN598XJA



J53 KP



05
Chrom
Polished chrome



98
Ultra Mattnickel
PVD Satin inox

J53KPXXX

Bezeichnung - Description

Farbe - Finishes

Alte art. nr - Old code

1 Stück - Piece

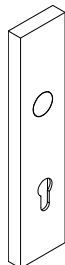

Außenschild System GF3, Höhe 13mm, mit 1 Stütznocke M6 und 2 Stütznocken M8 für Schildverschraubung 72mm, PZ

Exterior plate System GF3, height 13 mm, with 1 support cam M6 and 2 support cams M8 for plate bolting, 72mm Euro Profile cylinder

Chrom - Polished chrome

978-872-200-000

1AJ53KPXXX1305XJA

Ultra Mattnickel - PVD Satin inox

978-872-200-066

1AJ53KPXXX1398XJA

Außenschild System GF3, Höhe 13mm, mit 1 Stütznocke M6 und 2 Stütznocken M8 für Schildverschraubung 92mm, PZ

Exterior plate System GF3, height 13 mm, with 1 support cam M6 and 2 support cams M8 for plate bolting, 92mm Euro Profile cylinder

Chrom - Polished chrome

978-892-200-000

1AJ53KPXXX1505XJA

Ultra Mattnickel - PVD Satin inox

978-892-200-066

1AJ53KPXXX1598XJA



J57 KP



05
Chrom
Polished chrome



46
Ultra Mattnickel
PVD Gold

J57KPXXX

Bezeichnung - Description

Farbe - Finishes

Alte art. nr - Old code

1 Stück - Piece

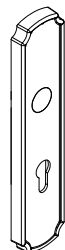

Außenschild System AC3, Höhe 14mm, 72mm PZ, ohne ZA, mit 1 Stütznocke M6 und 2 Stütznocken M8 für Schildverschraubung 72mm, PZ

Exterior plate System GF3, height 14 mm, 72mm euro profile cylinder key hole, with 1 support cam M6 and 2 support cams M8 for plate bolting 72mm Euro Profile cylinder

Chrom - Polished chrome

958-872-200-000

1AJ57KPXXX1305XJA

Ultra Messing - PVD Gold

958-872-200-367

1AJ57KPXXX1346XJA

Außenschild System AC3, Höhe 14mm, 72mm PZ, ohne ZA, mit 1 Stütznocke M6 und 2 Stütznocken M8 für Schildverschraubung 92mm, PZ

Exterior plate System GF3, height 14 mm, 72mm euro profile cylinder key hole, with 1 support cam M6 and 2 support cams M8 for plate bolting 92mm Euro Profile cylinder

Chrom - Polished chrome

958-892-200-000

1AJ57KPXXX1505XJA

Ultra Messing - PVD Gold

958-892-200-367

1AJ57KPXXX1546XJA





J73KPXXX

Bezeichnung - Description

Farbe - Finishes

Alte art. nr - Old code

1 Stück - Piece

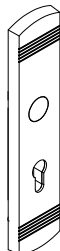

**Außenschild System AC3,
Höhe 13mm, mit 1 Stütznocke
M6 und 2 Stütznocken M8 für
Schildverschraubung 72mm, PZ**

Exterior plate System AC3, height
13 mm, with 1 support cam M6
and 2 support cams M8 for plate
bolting 72mm Euro Profile cylinder

Farbe - Finishes	Alte art. nr - Old code	1 Stück - Piece
Chrom - Polished chrome	352-872-200-000	1AJ73KPXXX1305XJA
Messing Rustik - Rustic brass	352-872-200-01M	1AJ73KPXXX131MXJA
Ultra Messing - PVD Gold	352-872-200-367	1AJ73KPXXX1346XJA
Ultra Mattnickel - PVD Satin inox	352-872-200-066	1AJ73KPXXX1398XJA

**Außenschild System AC3,
Höhe 13mm, mit 1 Stütznocke
M6 und 2 Stütznocken M8 für
Schildverschraubung 92mm, PZ**

Exterior plate System AC3, height
13 mm, with 1 support cam M6
and 2 support cams M8 for plate
bolting 92mm Euro Profile cylinder

Farbe - Finishes	Alte art. nr - Old code	1 Stück - Piece
Chrom - Polished chrome	352-892-200-000	1AJ73KPXXX1505XJA
Messing Rustik - Rustic brass	352-892-200-01M	1AJ73KPXXX151MXJA
Ultra Messing - PVD Gold	352-892-200-367	1AJ73KPXXX1546XJA
Ultra Mattnickel - PVD Satin inox	352-892-200-066	1AJ73KPXXX1598XJA



J51 KP

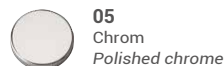

05
Chrom
Polished chrome



18
Schwarz RAL 9005
Matt black RAL 9005

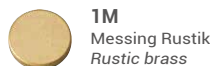

1M
Messing Rustik
Rustic brass



46
Ultra Mattnickel
PVD Gold



98
Ultra Mattnickel
PVD Satin inox

J51KP220

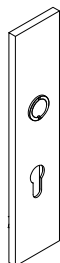

Bezeichnung - Description	Farbe - Finishes	Alte art. nr - Old code	1 Stück - Piece
Innenschild, Höhe 8mm, passend zu System GF2, GF3 und AC3, für Schildverschraubung mit 1 Schraube M6 und 2 Schrauben M8 Innenschild Höhe 8mm, passend zu System GF2, GF3 und AC3, für Schildverschraubung mit 1 Schraube M6 und 2 Schrauben M8 72mm, PZ (Schrauben nicht enthalten) <i>Interior plate, height 8mm, suitable for system GF2, GF3 and AC3, for plate bolting with 1 screw M6 and 2 screws M8</i> <i>Interior plate height 8mm, suitable for system GF2, GF3 and AC3, für plate bolting with 1 screw M6 and 2 screws M8 72mm Euro Profile cylinder (Screws not included)</i>	Chrom - Polished chrome	962-472-200-000	1AJ51KP2201305XJA
	Schwarz RAL 9005 - Matt black RAL 9005	962-472-200-180	1AJ51KP2201318XJA
	Messing Rustik - Rustic brass	962-472-200-01M	1AJ51KP220131MXJA
	Ultra Messing - PVD Gold	962-472-200-367	1AJ51KP2201346XJA
	Ultra Mattnickel - PVD Satin inox	962-472-200-066	1AJ51KP2201398XJA
Innenschild, Höhe 8mm, passend zu System GF2, GF3 und AC3, für Schildverschraubung mit 1 Schraube M6 und 2 Schrauben M8 Innenschild Höhe 8mm, passend zu System GF2, GF3 und AC3, für Schildverschraubung mit 1 Schraube M6 und 2 Schrauben M8 92mm, PZ (Schrauben nicht enthalten) <i>Interior plate, height 8mm, suitable for system GF2, GF3 and AC3, for plate bolting with 1 screw M6 and 2 screws M8</i> <i>Interior plate height 8mm, suitable for system GF2, GF3 and AC3, für plate bolting with 1 screw M6 and 2 screws M8 92mm Euro Profile cylinder (Screws not included)</i>	Chrom - Polished chrome	962-492-200-000	1AJ51KP2201505XJA
	Schwarz RAL 9005 - Matt black RAL 9005	962-492-200-180	1AJ51KP2201518XJA
	Messing Rustik - Rustic brass	962-492-200-01M	1AJ51KP220151MXJA
	Ultra Messing - PVD Gold	962-492-200-367	1AJ51KP2201546XJA
	Ultra Mattnickel - PVD Satin inox	962-492-200-066	1AJ51KP2201598XJA

J56 KP

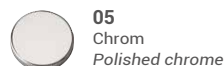

05
Chrom
Polished chrome



46
Ultra Mattnickel
PVD Gold



98
Ultra Mattnickel
PVD Satin inox

J56KPXXX

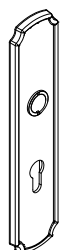

Bezeichnung - Description	Farbe - Finishes	Alte art. nr - Old code	1 Stück - Piece
Innenschild, Höhe 9mm, passend zu System GF2, GF3 und AC3, für Schildverschraubung mit 1 Schraube M6 und 2 Schrauben M8 72mm, PZ (Schrauben nicht enthalten) <i>Interior plate, height 9mm, suitable for system GF2, GF3 and AC3, für plate bolting with 1 screw M6 and 2 screws M8 72mm Euro Profile cylinder (Screws not included)</i>	Chrom - Polished chrome	966-472-200-000	1AJ56KPXXX1305XJA
	Ultra Messing - PVD Gold	966-472-200-367	1AJ56KPXXX1346XJA
	Ultra Mattnickel - PVD Satin inox	966-472-200-066	1AJ56KPXXX1398XJA
Innenschild, Höhe 9mm, passend zu System GF2, GF3 und AC3, für Schildverschraubung mit 1 Schraube M6 und 2 Schrauben M8 92mm, PZ (Schrauben nicht enthalten) <i>Interior plate, height 9mm, suitable for system GF2, GF3 and AC3, für plate bolting with 1 screw M6 and 2 screws M8 92mm Euro Profile cylinder (Screws not included)</i>	Chrom - Polished chrome	966-492-200-000	1AJ56KPXXX1505XJA
	Ultra Messing - PVD Gold	966-492-200-367	1AJ56KPXXX1546XJA
	Ultra Mattnickel - PVD Satin inox	966-492-200-066	1AJ56KPXXX1598XJA

J61 KP

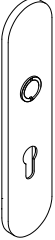

J61KP220	Bezeichnung - Description	Farbe - Finishes	Alte art. nr - Old code	1 Stück - Piece
 <p>Innenschild Höhe 8mm, passend zu System GF2, GF3 und AC3, für Schildverschraubung mit 1 Schraube M6 und 2 Schrauben M8 Innenschild Höhe 8mm, passend zu System GF2, GF3 und AC3, für Schildverschraubung mit 1 Schraube M6 und 2 Schrauben M8 72mm, PZ (Schrauben nicht enthalten)</p> <p><i>Interior plate height 8mm, suitable for system GF2, GF3 and AC3, für plate bolting with 1 screw M6 and 2 screws M8 Interior plate height 8mm, suitable for system GF2, GF3 and AC3, für plate bolting with 1 screw M6 and 2 screws M8 72mm Euro Profile cylinder (Screws not included)</i></p>	Ultra Mattnickel - PVD Satin inox	343-472-200-066	1AJ61KP2201398XJA	
	Ultra Mattnickel - PVD Satin inox	343-492-200-066	1AJ61KP2201598XJA	
<p>Innenschild Höhe 8mm, passend zu System GF2, GF3 und AC3, für Schildverschraubung mit 1 Schraube M6 und 2 Schrauben M8 Innenschild Höhe 8mm, passend zu System GF2, GF3 und AC3, für Schildverschraubung mit 1 Schraube M6 und 2 Schrauben M8 92mm, PZ (Schrauben nicht enthalten)</p> <p><i>Interior plate height 8mm, suitable for system GF2, GF3 and AC3, für plate bolting with 1 screw M6 and 2 screws M8 Interior plate height 8mm, suitable for system GF2, GF3 and AC3, für plate bolting with 1 screw M6 and 2 screws M8 92mm Euro Profile cylinder (Screws not included)</i></p>	Ultra Mattnickel - PVD Satin inox	343-492-200-066	1AJ61KP2201598XJA	

J71 KP

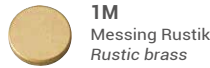

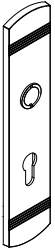
J71KPXXX	Bezeichnung - Description	Farbe - Finishes	Alte art. nr - Old code	1 Stück - Piece
 <p>Innenschild Höhe 8mm, passend zu System GF2, GF3 und AC3, für Schildverschraubung mit 1 Schraube M6 und 2 Schrauben M8 72mm, PZ (Schrauben nicht enthalten)</p> <p><i>Interior plate, height 8mm, suitable for system GF2, GF3 and AC3, für plate bolting with 1 screw M6 and 2 screws M8 72mm Euro Profile cylinder (Screws not included)</i></p>	Chrom - Polished chrome	353-472-200-000	1AJ71KPXXX1305XJA	
	Schwarz RAL 9005 - Matt black RAL 9005	353-472-200-180	1AJ71KPXXX1318XJA	
	Messing Rustik - Rustic brass	353-472-200-01M	1AJ71KPXXX131MXJA	
	Ultra Messing - PVD Gold	353-472-200-367	1AJ71KPXXX1346XJA	
	Ultra Mattnickel - PVD Satin inox	353-472-200-066	1AJ71KPXXX1398XJA	
<p>Innenschild Höhe 8mm, passend zu System GF2, GF3 und AC3, für Schildverschraubung mit 1 Schraube M6 und 2 Schrauben M8 92mm, PZ (Schrauben nicht enthalten)</p> <p><i>Interior plate, height 8mm, suitable for system GF2, GF3 and AC3, für plate bolting with 1 screw M6 and 2 screws M8 92mm Euro Profile cylinder (Screws not included)</i></p>	Chrom - Polished chrome	353-492-200-000	1AJ71KPXXX1505XJA	
	Schwarz RAL 9005 - Matt black RAL 9005	353-492-200-180	1AJ71KPXXX1518XJA	
	Messing Rustik - Rustic brass	353-492-200-01M	1AJ71KPXXX151MXJA	
	Ultra Messing - PVD Gold	353-492-200-367	1AJ71KPXXX1546XJA	
	Ultra Mattnickel - PVD Satin inox	353-492-200-066	1AJ71KPXXX1598XJA	

412 CD



412CDJ00

Bezeichnung - Description

Farbe - Finishes

Alte art. nr - Old code

1 Stück - Piece



Looser Kernziehschutz für GF1, GF2 und GF5

Cylinder cover für GF1, GF2 und GF5

Farbe - Finishes	Alte art. nr - Old code	1 Stück - Piece
Chrom - Polished chrome	000-387-000-000	1A412CDJ00XX05XXX
Ultra Messing - PVD Gold	000-387-000-367	1A412CDJ00XX46XXX
Edelstahl Spiegelpol. - Polished Stainless Steel	000-387-000-155	1A412CDJ00XX50XXX
Edelstahl - Stainless steel 304	000-387-000-055	1A412CDJ00XX5SXXX

413 CD



413CDJ00

Bezeichnung - Description

Farbe - Finishes

Alte art. nr - Old code

1 Stück - Piece



Looser Kernziehschutz für GF3

Cylinder cover für GF3

Farbe - Finishes	Alte art. nr - Old code	1 Stück - Piece
Chrom - Polished chrome	000-388-000-000	1A413CDJ00XX05XXX
Schwarz RAL 9005 - Matt black RAL 9005	000-388-000-180	1A413CDJ00XX18XXX
Messing Rustik - Rustic brass	000-388-000-01M	1A413CDJ00XX1MXXX
Ultra Messing - PVD Gold	000-388-000-367	1A413CDJ00XX46XXX
Ultra Mattnickel - PVD Satin inox	000-388-000-066	1A413CDJ00XX98XXX







 JATEC

KNÖPFE UND TÜRSTOPPER

KNOBS AND DOOR STOPS



-  **05**
Chrom
Polished chrome
-  **46**
Ultra Messing
PVD Gold
-  **98**
Ultra Mattnickel
PVD Satin inox

J01PQXXX	Bezeichnung - Description	Farbe - Finishes	Alte art. nr - Old code	1 Stück - Piece
	Knopflochteil Ø50 mm 8mm VK <i>Knob only Ø50 mm with 8mm spindle</i>	Chrom - Polished chrome	420-508-300-000	1AJ01PQXXX6605XJA
Ultra Messing - PVD Gold 		420-508-300-367	1AJ01PQXXX6646XJA	
Ultra Mattnickel - PVD Satin inox 		420-508-300-066	1AJ01PQXXX6698XJA	

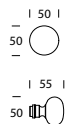



J01 PF J01



Montagehinweise finden Sie ab Seite 488
For mounting instructions please look at page 488



-  **05**
Chrom
Polished chrome
-  **46**
Ultra Messing
PVD Gold
-  **98**
Ultra Mattnickel
PVD Satin inox

J01PFJ01	Bezeichnung - Description	Farbe - Finishes	Alte art. nr - Old code	1 Stück - Piece
	Knopf einzeln, einseitig festehende Befestigung Ø50 mm, Knopfrose Ø50mm <i>Fixed knob Ø50 mm Fixed knob on rose Ø50mm</i>	Chrom - Polished chrome	420-373-K00-000	1AJ01PFJ01XX05FJA
Ultra Messing - PVD Gold 		420-373-K00-367	1AJ01PFJ01XX46FJA	
Ultra Mattnickel - PVD Satin inox 		420-373-K00-066	1AJ01PFJ01XX98FJA	

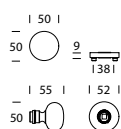





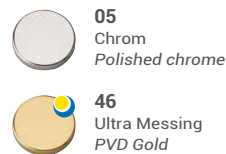

J02PQXXX	Bezeichnung - Description	Farbe - Finishes	Alte art. nr - Old code	1 Stück - Piece
	Knopflochteil Ø50 mm 8mm VK Knob only Ø50 mm with 8mm spindle	Chrom - Polished chrome	922-508-300-000	1AJ02PQXXX6605XJA
		Ultra Messing - PVD Gold	922-508-300-367	1AJ02PQXXX6646XJA

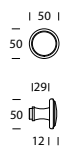

J02 PF J01



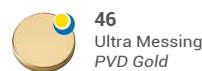

Montagehinweise finden Sie ab Seite 488
For mounting instructions please look at page 488

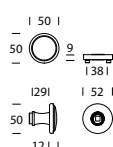

J02PFJ01	Bezeichnung - Description	Farbe - Finishes	Alte art. nr - Old code	1 Stück - Piece
	Knopf einzeln, einseitig festehende Befestigung Ø50 mm, Knopfrosette Ø50mm Fixed knob Ø50 mm Fixed knob on rose Ø50mm	Ultra Messing - PVD Gold	922-373-K00-367	1AJ02PFJ01XX46FJA





-  **05**
Chrom
Polished chrome
-  **18**
Schwarz RAL9005
Matt black RAL9005

J03PQXXX	Bezeichnung - Description	Farbe - Finishes	Alte art. nr - Old code	1 Stück - Piece
	Knopflochteil 50x50 mm 8mm VK Knob only 50x50 mm with 8mm spindle	Chrom - Polished chrome	373-508-300-000	1AJ03PQXXX6605XJA
		Schwarz RAL 9005 - Matt black RAL 9005	373-508-300-180	1AJ03PQXXX6618XJA

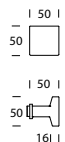

J03 PF J30



Montagehinweise finden Sie ab Seite 488
For mounting instructions please look at page 488



-  **05**
Chrom
Polished chrome
-  **18**
Schwarz RAL9005
Matt black RAL9005
-  **46**
Ultra Messing
PVD Gold

J03PFJ30	Bezeichnung - Description	Farbe - Finishes	Alte art. nr - Old code	1 Stück - Piece
	Knopf einzeln, einseitig festehende Befestigung 50x50 mm, Knopfrossette 52x52mm Fixed knob 50x50 mm Fixed knob on rose 52x52 mm	Chrom - Polished chrome	373-371-K00-000	1AJ03PFJ30XX05FJA
		Schwarz RAL 9005 - Matt black RAL 9005	373-371-K00-180	1AJ03PFJ30XX18FJA
		Ultra Messing - PVD Gold 	373-371-K00-367	1AJ03PFJ30XX46FJA

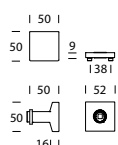

 MESSING BRASS
  PVD ULTRA FINISH
  PLUS FINISH



-  **02**
Messing Poliert
Polished varnished
-  **05**
Chrom
Polished chrome

J01FEXXX	Bezeichnung - Description	Farbe - Finishes	Alte art. nr - Old code	1 Stück - Piece
		Messing Poliert - Polished varnished	453-000-000-001	1AJ01FEXXXXX02XJA
		Chrom - Polished chrome	453-000-000-000	1AJ01FEXXXXX05XJA

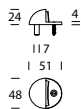

Türstopper 48mm DM
Door stop ø48 mm

J02 FE



-  **05**
Chrom
Polished chrome
-  **31**
Mattnickel
Satin nickel

J02FEXXX	Bezeichnung - Description	Farbe - Finishes	Alte art. nr - Old code	1 Stück - Piece
		Chrom - Polished chrome	453-040-000-000	1AJ02FEXXXXX05XJA



Türstopper 40mm DM
Door stop ø40 mm





JATEC

HEBE
SCHIEBETÜRBESCHLÄGE
PULL HANDLES FOR LIFT
AND SLIDING DOORS



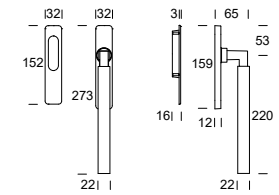

J04HSQ1369



















J04HSQ1300



J04HDQ1369



Q13PI002

J04MDQ00	Bezeichnung - Description	Farbe - Finishes	Alte art. nr - Old code	1 Stück - Piece
	Hebe- / Schiebetürgriff auf Schild PZ (euro profile cylinder key hole) <i>Single pull handle for lift and slide, with euro profile cylinder plate without flush pull plate</i>	Chrom - Polished chrome	-	1AJ04HSQ136905XJA
		Schwarz RAL 9005 - Matt black RAL 9005	-	1AJ04HSQ136918XJA
		Ultra Messing - PVD Gold 	-	1AJ04HSQ136946XJA
		Ultra Mattnickel - PVD Satin inox 	-	1AJ04HSQ136998XJA
		Nickel spiegelpol. Plus - Pol. Nickel Plus 	-	1AJ04HSQ1369K1XJA
	Hebe- / Schiebetürgriff auf Schild ohne Loch <i>Single pull handle for lift and slide, blind without flush pull plate</i>	Chrom - Polished chrome	-	1AJ04HSQ130005XJA
		Schwarz RAL 9005 - Matt black RAL 9005	-	1AJ04HSQ130018XJA
		Ultra Messing - PVD Gold 	-	1AJ04HSQ130046XJA
		Ultra Mattnickel - PVD Satin inox 	-	1AJ04HSQ130098XJA
		Nickel spiegelpol. Plus - Pol. Nickel Plus 	-	1AJ04HSQ1300K1XJA
	Hebe- / Schiebetürgriff Set PZ Paar Hebe- / Schiebetürgriffe auf Schild PZ <i>Pair pull handles for lift and slide with Euro profile hole</i>	Chrom - Polished chrome	-	1AJ04HDQ136905XJA
		Schwarz RAL 9005 - Matt black RAL 9005	-	1AJ04HDQ136918XJA
		Ultra Messing - PVD Gold 	-	1AJ04HDQ136946XJA
		Ultra Mattnickel - PVD Satin inox 	-	1AJ04HDQ136998XJA
		Nickel spiegelpol. Plus - Pol. Nickel Plus 	-	1AJ04HDQ1369K1XJA
	Schiebetürmuschel ohne Loch <i>Flush pull plate for lift and slide pull handle without key hole</i>	Chrom - Polished chrome	-	1AQ13PI002XX05XJA
		Schwarz RAL 9005 - Matt black RAL 9005	-	1AQ13PI002XX18XJA
		Ultra Messing - PVD Gold 	-	1AQ13PI002XX46XJA
		Ultra Mattnickel - PVD Satin inox 	-	1AQ13PI002XX98XJA
		Nickel spiegelpol. Plus - Pol. Nickel Plus 	-	1AQ13PI002XXK1XJA



05
Chrom
Polished chrome

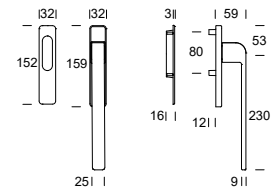

J26HSQ1369





J26HSQ1300



J26HDQ1369



Q13PI002

J26MDQ00	Bezeichnung - Description	Farbe - Finishes	Alte art. nr - Old code	1 Stück - Piece
	<p>Hebe- / Schiebetürgriff auf Schild PZ (euro profile cylinder key hole)</p> <p>Single pull handle for lift and slide, with euro profile cylinder plate without flush pull plate</p>	<p>Chrom - Polished chrome</p>	<p>-</p>	<p>1AJ26HSQ136905XJA</p>
	<p>Hebe- / Schiebetürgriff auf Schild ohne Loch</p> <p>Single pull handle for lift and slide, blind without flush pull plate</p>	<p>Chrom - Polished chrome</p>	<p>-</p>	<p>1AJ26HSQ130005XJA</p>
	<p>Hebe- / Schiebetürgriff Set PZ Paar Hebe- / Schiebetürgriffe auf Schild PZ</p> <p>Pair pull handles for lift and slide with Euro profile hole</p>	<p>Chrom - Polished chrome</p>	<p>-</p>	<p>1AJ26HDQ136905XJA</p>
	<p>Schiebetürmuschel ohne Loch</p> <p>Flush pull plate for lift and slide pull handle without key hole</p>	<p>Chrom - Polished chrome</p>	<p>-</p>	<p>1AQ13PI002XX05XJA</p>



05
Chrom
Polished chrome



46
Ultra Messing
PVD Gold

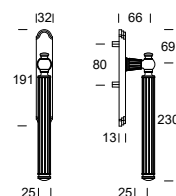

J18HS31369





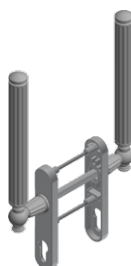





J18HS31300



J18HD31369



313PI002

J18MDC00	Bezeichnung - Description	Farbe - Finishes	Alte art. nr - Old code	1 Stück - Piece
	Hebe- / Schiebetürgriff auf Schild PZ (euro profile cylinder key hole) Single pull handle for lift and slide, with euro profile cylinder plate without flush pull plate	Chrom - Polished chrome	-	1AJ18HS3136905XJA
		Ultra Messing - PVD Gold 	-	1AJ18HS3136946XJA
	Hebe- / Schiebetürgriff auf Schild ohne Loch Single pull handle for lift and slide, blind without flush pull plate	Chrom - Polished chrome	-	1AJ18HS3130005XJA
		Ultra Messing - PVD Gold 	-	1AJ18HS3130046XJA
	Hebe- / Schiebetürgriff Set PZ Paar Hebe- / Schiebetürgriffe auf Schild PZ Pair pull handles for lift and slide with Euro profile hole	Chrom - Polished chrome	-	1AJ18HD3136905XJA
		Ultra Messing - PVD Gold 	-	1AJ18HD3136946XJA
	Schiebtürmuschel ohne Loch Flush pull plate for lift and slide pull handle without key hole	Chrom - Polished chrome	-	1A313PI002XX05XJA
		Ultra Messing - PVD Gold 	-	1A313PI002XX46XJA



JTC

TÜR-UND FENSTERBESCHLÄGE

DOOR AND WINDOW
HARDWARE

Charme 900

MESSING - BRASS

Datenblatt
Datasheet



1M
Messing Rustik
Rustic brass



47
Messing Altgrau
Old silver



BQ
Messing Antik Braun
Antique brass

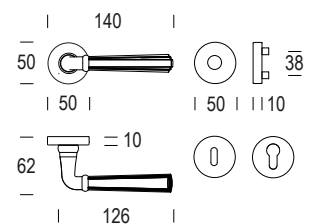

TÜRDRÜCKERGARNITUREN



900MRD17



900MR009



900MP040

WECHSELGARNITUREN



900PMD02



900PM011

WC GARNITUREN



900RGD17



900RG009



900PG040

FENSTERGRIFFE



900DK015



























900DK075









900DKC80



900DKT80

900MRD17	Bezeichnung - Description	Farbe - Finishes	Alte art. nr - Old code	1 Stück - Piece
 	Doppelte Bezeichnung Ø50x10 mm Schlüsselloch Pair lever handle on rose Ø50x10 mm key hole	Messing Rustik - Rustic brass	90C-D17-031-01M	1A900MRD17311MZZA
		Messing Altgrau - Old silver 	90C-D17-031-047	1A900MRD173147ZZA
		Messing Antik Braun - Antique 	90C-D17-031-0BQ	1A900MRD1731BQZZA
 	Doppelte Bezeichnung Ø50x10 mm PZ Pair lever handle on rose Ø50x10 mm euro profile cylinder hole	Messing Rustik - Rustic brass	90C-D17-032-01M	1A900MRD17321MZZA
		Messing Altgrau - Old silver 	90C-D17-032-047	1A900MRD173247ZZA
		Messing Antik Braun - Antique 	90C-D17-032-0BQ	1A900MRD1732BQZZA
 	WC-Garnitur mit Rosetten Ø50x10 mm mit Riegel 512 und Schlitzschraube 8mm VK Lever handle on rose Ø50x10 mm with 512 turn and release with 8 mm spindle	Messing Rustik - Rustic brass	90C-D17-900-01M	1A900RGD17421MZZA
		Messing Altgrau - Old silver 	90C-D17-900-047	1A900RGD174247ZZA
		Messing Antik Braun - Antique 	90C-D17-900-0BQ	1A900RGD1742BQZZA
 	Doppelte Bezeichnung 32x62x10 mm Schlüsselloch Pair lever handle on rose 32x62x10 mm key hole	Messing Rustik - Rustic brass	90C-009-031-01M	1A900MR009311MDZA
		Messing Altgrau - Old silver 	90C-009-031-047	1A900MR0093147DZA
		Messing Antik Braun - Antique 	90C-009-031-0BQ	1A900MR00931BQDZA
 	Doppelte Bezeichnung 32x62x10 mm PZ Pair lever handle on rose 32x62x10 mm euro profile cylinder hole	Messing Rustik - Rustic brass	90C-009-032-01M	1A900MR009321MDZA
		Messing Altgrau - Old silver 	90C-009-032-047	1A900MR0093247DZA
		Messing Antik Braun - Antique 	90C-009-032-0BQ	1A900MR00932BQDZA
 	WC-Garnitur mit ovale Rosetten 32x62x10 mm mit Riegel 512 und Schlitzschraube 8mm VK Lever handle on oval rose 32x62x10 mm with 512 turn and release with 8 mm spindle	Messing Rustik - Rustic brass	90C-009-900-01M	1A900RG009421MDZA
		Messing Altgrau - Old silver 	90C-009-900-047	1A900RG0094247DZA
		Messing Antik Braun - Antique 	90C-009-900-0BQ	1A900RG00942BQDZA

900MP040	Bezeichnung - Description	Farbe - Finishes	Alte art. nr - Old code	1 Stück - Piece
	ZT-Garnitur mit Schild mit IB 72 mm <i>Pair lever handle on plate with standard key hole 72mm</i>	Messing Rustik - Rustic brass	90C-040-006-01M	1A900MP040061MDZA
		Messing Altgrau - Old silver	90C-040-006-047	1A900MP0400647DZA
		Messing Antik Braun - Antique	90C-040-006-0BQ	1A900MP04006BQDZA
	ZT-Garnitur mit Schild mit PZ 72 mm <i>Pair lever handle on plate with Euro Profile cylinder hole 72mm</i>	Messing Rustik - Rustic brass	90C-040-013-01M	1A900MP040131MDZA
		Messing Altgrau - Old silver	90C-040-013-047	1A900MP0401347DZA
		Messing Antik Braun - Antique	90C-040-013-0BQ	1A900MP04013BQDZA
	WE-Garnitur mit Knopf E56 72 mm PZ rechtszeigend <i>Entrance set lever handle / knob E56 with Euro Profile cylinder hole 72mm (right hand)</i>	Messing Rustik - Rustic brass	90C-040-D13-01M	1A900PM011131MJZA
		Messing Altgrau - Old silver	90C-040-D13-047	1A900PM0111347JZA
		Messing Antik Braun - Antique	90C-040-D13-0BQ	1A900PM01113BQJZA
	WE-Garnitur mit Knopf E56 72 mm PZ linkszeigend <i>Entrance set lever handle / knob E56 with Euro Profile cylinder hole 72mm (left hand)</i>	Messing Rustik - Rustic brass	90C-040-S13-01M	1A900PM011131MLZA
		Messing Altgrau - Old silver	90C-040-S13-047	1A900PM0111347LZA
		Messing Antik Braun - Antique	90C-040-S13-0BQ	1A900PM01113BQLZA
	WC-Garnitur mit Schild 40x246 mm, Riegel 512 & Schlitzschraube 8mm VK <i>Pair lever handle on plate with 512 turn and release (8mm WC spindle)</i>	Messing Rustik - Rustic brass	90C-040-600-01M	1A900PG040241MVZA
		Messing Altgrau - Old silver	90C-040-600-047	1A900PG0402447VZA
		Messing Antik Braun - Antique	90C-040-600-0BQ	1A900PG04024BQVZA

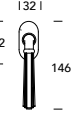
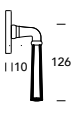
900DK015	Bezeichnung - Description	Farbe - Finishes	Alte art. nr - Old code	1 Stück - Piece
  	Fensterolive ovale Ros. 30x65 ohne Rastergehäuse (separat zu notieren*) Dreh Kipp on rose without mechanism (to be ordered separately*)	Messing Rustik - Rustic brass	90C-411-110-01M	1A900DK015001MXZA
		Messing Altgrau - Old silver	90C-411-110-047	1A900DK0150047XZA
		Messing Antik Braun - Antique	90C-411-110-0BQ	1A900DK01500BQXZA
	Fensterolive ovale Ros. 30x65 inklusive Rastergehäuse mit 30 mm vorstehendem Stift Dreh Kipp on rose and 7x30 mm spindle (mechanism included)	Messing Rustik - Rustic brass	90C-411-000-01M	1A900DK015301MXZA
		Messing Altgrau - Old silver	90C-411-000-047	1A900DK0153047XZA
		Messing Antik Braun - Antique	90C-411-000-0BQ	1A900DK01530BQXZA
	Fensterolive ovale Ros. 30x65 inklusive Reastergehäuse mit 35 mm vorstehendem Stift Dreh Kipp on rose and 7x35 mm spindle (mechanism included)	Messing Rustik - Rustic brass	90C-411-200-01M	1A900DK015351MXZA
		Messing Altgrau - Old silver	90C-411-200-047	1A900DK0153547XZA
		Messing Antik Braun - Antique	90C-411-200-0BQ	1A900DK01535BQXZA

*Rastergehäuse finden Sie auf Seite 419 / For mechanism please see page 419

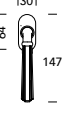
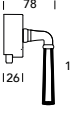
900DK075	Bezeichnung - Description	Farbe - Finishes	Alte art. nr - Old code	1 Stück - Piece
  	Fensterolive mit Druckknopf Ros. 30x64 inklusive Rastergehäuse mit 30 mm vorstehendem Stift Dreh Kipp with push button on rose (mechanism included) and 7x30 mm spindle (mechanism included)	Messing Rustik - Rustic brass	90C-075-030-01M	1A900DK075301MXZA
		Messing Altgrau - Old silver	90C-075-030-047	1A900DK0753047XZA
		Messing Antik Braun - Antique	90C-075-030-0BQ	1A900DK07530BQXZA
	Fensterolive mit Druckknopf Ros. 30x64 inklusive Reastergehäuse mit 35 mm vorstehendem Stift Dreh Kipp with push button on rose (mechanism included) and 7x35 mm spindle (mechanism included)	Messing Rustik - Rustic brass	90C-075-035-01M	1A900DK075351MXZA
		Messing Altgrau - Old silver	90C-075-035-047	1A900DK0753547XZA
		Messing Antik Braun - Antique	90C-075-035-0BQ	1A900DK07535BQXZA
	Fensterolive mit Druckknopf Ros. 30x64 mit 50 mm vorstehendem Stift Dreh Kipp with push button on rose (mechanism included) and 7x50 mm spindle	Messing Rustik - Rustic brass	90C-075-050-01M	1A900DK075501MXZA
		Messing Altgrau - Old silver	90C-075-050-047	1A900DK0755047XZA
		Messing Antik Braun - Antique	90C-075-050-0BQ	1A900DK07550BQXZA

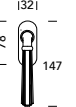
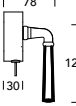
900DKC80	Bezeichnung - Description	Farbe - Finishes	Alte art. nr - Old code	1 Stück - Piece
  	Fensterolive "RC 2" zertifiziert Ros. 32x78 ohne Rastergehäuse (separat zu notieren*) DK with key RC2 certified on rose 32x78 without mechanism (to be ordered separately*)	Messing Rustik - Rustic brass	90C-C80-10E-01M	1A900DKC80001MXZA
		Messing Altgrau - Old silver	90C-C80-10E-047	1A900DKC800047XZA
		Messing Antik Braun - Antique	90C-C80-10E-0BQ	1A900DKC8000BQXZA
	Fensterolive "RC 2" zertifiziert Ros. 32x78 inklusive Rastergehäuse mit 30 mm vorstehendem Stift DK with key RC2 certified on rose 32x78 and 7x30 mm spindle (mechanism included)	Messing Rustik - Rustic brass	90C-C80-00E-01M	1A900DKC80301MXZA
		Messing Altgrau - Old silver	90C-C80-00E-047	1A900DKC803047XZA
		Messing Antik Braun - Antique	90C-C80-00E-0BQ	1A900DKC8030BQXZA
	Fensterolive "RC 2" zertifiziert Ros. 32x78 inklusive Rastergehäuse mit 35 mm vorstehendem Stift DK with key RC2 certified on rose 32x78 and 7x35 mm spindle (mechanism included)	Messing Rustik - Rustic brass	90C-C80-20E-01M	1A900DKC80351MXZA
		Messing Altgrau - Old silver	90C-C80-20E-047	1A900DKC803547XZA
		Messing Antik Braun - Antique	90C-C80-20E-0BQ	1A900DKC8035BQXZA

*Rastergehäuse finden Sie auf Seite 419 / For mechanism please see page 419

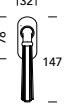
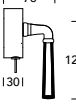
900DKT80	Bezeichnung - Description	Farbe - Finishes	Alte art. nr - Old code	1 Stück - Piece
  	Fensterolive mit TBT Funktion Ros. 32x78 ohne Rastergehäuse (separat zu notieren*) Dreh Kipp with key on rose 32x78 with TBT function without mechanism (to be ordered separately*)	Messing Rustik - Rustic brass	90C-T80-10E-01M	1A900DKT80001MXZA
		Messing Altgrau - Old silver	90C-T80-10E-047	1A900DKT800047XZA
		Messing Antik Braun - Antique	90C-T80-10E-0BQ	1A900DKT8000BQXZA
	Fensterolive mit TBT Funktion Ros. 32x78 inklusive Rastergehäuse mit 30 mm vorstehendem Stift Dreh Kipp with key on rose 32x78 with TBT function and 7x30 mm spindle (mechanism included)	Messing Rustik - Rustic brass	90C-T80-00E-01M	1A900DKT80301MXZA
		Messing Altgrau - Old silver	90C-T80-00E-047	1A900DKT803047XZA
		Messing Antik Braun - Antique	90C-T80-00E-0BQ	1A900DKT8030BQXZA
	Fensterolive mit TBT Funktion Ros. 32x78 inklusive Rastergehäuse mit 35 mm vorstehendem Stift Dreh Kipp with key on rose 32x78 with TBT function and 7x35 mm spindle (mechanism included)	Messing Rustik - Rustic brass	90C-T80-20E-01M	1A900DKT80351MXZA
		Messing Altgrau - Old silver	90C-T80-20E-047	1A900DKT803547XZA
		Messing Antik Braun - Antique	90C-T80-20E-0BQ	1A900DKT8035BQXZA

*Rastergehäuse finden Sie auf Seite 419 / For mechanism please see page 419



54
Porzellan Weiß / Messing
Altgrau
White porcelain / Old silver



59
Porzellan Champagne / Mes-
sing Antik Braun
Champagne porcelain / Antique
brass



65
Porzellan Weiß / Messing
Antik Braun
White porcelain / Antique
brass



85
Porzellan Schwarz / Messing
Altgrau
Black porcelain / Old silver



8E
Porzellan Champagne / Mes-
sing Rustik
Champagne porcelain / Rustic
brass

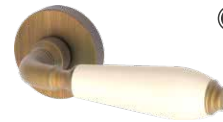

8N
Porzellan Champagne / Mes-
sing Brüniert
Champagne porcelain / Matt
brushed bronzed

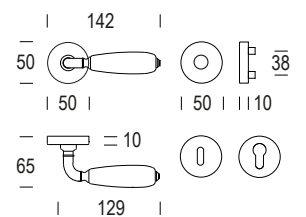

TÜRDRÜCKERGARNITUREN



069MRD17

WECHSELGARNITUREN



069PMD05

WC GARNITUREN



069RGD17

FENSTERGRIFFE



069DK015



069DK075



069DKC80



069DKT80

069MRD17	Bezeichnung - Description	Farbe - Finishes	Alte art. nr - Old code	1 Stück - Piece
	Doppelte Bezeichnung Ø50x10 mm Schlüssellochung <i>Pair lever handle on rose Ø50x10 mm key hole</i>	Porz. Weiß/Messing Altgrau - White porc./Old silver	069-D17-031-054	1A069MRD173154ZZA
		Porz. Champagne/Antik Braun - Champagne porc./Antique	069-D17-031-059	1A069MRD173159ZZA
		Porz. Weiß/Antik Braun - White Porc./Antique	069-D17-031-065	1A069MRD173165ZZA
		Porz. Schwarz/Messing Altgrau - Black porc./Old silver	069-D17-031-085	1A069MRD173185ZZA
		Porz. Champagne/Messing Rustik - Champagne Porc./Rustic	069-D17-031-08E	1A069MRD17318EZZA
		Porz. Champagne/Brüniert - Porc. Champagne/Bronzed	069-D17-031-08N	1A069MRD17318NZZA
	Doppelte Bezeichnung Ø50x10 mm PZ <i>Pair lever handle on rose Ø50x10 mm euro profile cylinder hole</i>	Porz. Weiß/Messing Altgrau - White porc./Old silver	069-D17-032-054	1A069MRD173254ZZA
		Porz. Champagne/Antik Braun - Champagne porc./Antique	069-D17-032-059	1A069MRD173259ZZA
		Porz. Weiß/Antik Braun - White Porc./Antique	069-D17-032-065	1A069MRD173265ZZA
		Porz. Schwarz/Messing Altgrau - Black porc./Old silver	069-D17-032-085	1A069MRD173285ZZA
		Porz. Champagne/Messing Rustik - Champagne Porc./Rustic	069-D17-032-08E	1A069MRD17328EZZA
		Porz. Champagne/Brüniert - Porc. Champagne/Bronzed	069-D17-032-08N	1A069MRD17328NZZA
	WE-Garnitur mit Knopf E56 PZ beidseitig verwendbar <i>Entrance set lever handle / knob E56 Euro profile cylinder hole (LH/RH)</i>	Porz. Weiß/Messing Altgrau - White porc./Old silver	069-D17-Y56-054	1A069PMD053254YZA
		Porz. Champagne/Antik Braun - Champagne porc./Antique	069-D17-Y56-059	1A069PMD053259YZA
		Porz. Weiß/Antik Braun - White Porc./Antique	069-D17-Y56-065	1A069PMD053265YZA
		Porz. Schwarz/Messing Altgrau - Black porc./Old silver	069-D17-Y56-085	1A069PMD053285YZA
		Porz. Champagne/Messing Rustik - Champagne Porc./Rustic	069-D17-Y56-08E	1A069PMD05328EYZA
		Porz. Champagne/Brüniert - Porc. Champagne/Bronzed	069-D17-Y56-08N	1A069PMD05328NYZA
	WC-Garnitur mit Rosetten Ø50x10 mm mit Riegel 512 und Schlitzschraube 8mm VK <i>Lever handle on rose Ø50x10 mm with 512 turn and release with 8 mm spindle</i>	Porz. Weiß/Messing Altgrau - White porc./Old silver	069-D17-900-054	1A069RGD174254ZZA
		Porz. Champagne/Antik Braun - Champagne porc./Antique	069-D17-900-059	1A069RGD174259ZZA
		Porz. Weiß/Antik Braun - White Porc./Antique	069-D17-900-065	1A069RGD174265ZZA
		Porz. Schwarz/Messing Altgrau - Black porc./Old silver	069-D17-900-085	1A069RGD174285ZZA
		Porz. Champagne/Messing Rustik - Champagne Porc./Rustic	069-D17-900-08E	1A069RGD17428EZZA
		Porz. Champagne/Brüniert - Porc. Champagne/Bronzed	069-D17-900-08N	1A069RGD17428NZZA

FENSTERGRIFFE - WINDOW HANDLES

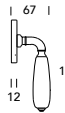
069DK015	Bezeichnung - Description	Farbe - Finishes	Alte art. nr - Old code	1 Stück - Piece
	Fensterolive ovale Ros. 30x65 ohne Rastergehäuse (separat zu notieren*) <i>Dreh Kipp on rose without mechanism (to be ordered separately*)</i>	Porz. Weiß/Messing Altgrau - White porc./Old silver	069-411-110-054	1A069DK0150054XZA
		Porz. Champagne/Antik Braun - Champagne porc./Antique	069-411-110-059	1A069DK0150059XZA
		Porz. Weiß/Antik Braun - White Porc./Antique	069-411-110-065	1A069DK0150065XZA
		Porz. Schwarz/Messing Altgrau - Black porc./Old silver	694-111-100-85	1A069DK0150085XZA
		Porz. Champagne/Messing Rustik - Champagne Porc./Rustic	069-411-110-08E	1A069DK015008EXZA
		Porz. Champagne/Brüniert - Porc. Champagne/Bronzed	069-411-110-08N	1A069DK015008NXZA
	Fensterolive ovale Ros. 30x65 inklusive Rastergehäuse mit 30 mm vorstehendem Stift <i>Dreh Kipp on rose and 7x30 mm spindle (mechanism included)</i>	Porz. Weiß/Messing Altgrau - White porc./Old silver	069-411-000-054	1A069DK0153054XZA
		Porz. Champagne/Antik Braun - Champagne porc./Antique	069-411-000-059	1A069DK0153059XZA
		Porz. Weiß/Antik Braun - White Porc./Antique	069-411-000-065	1A069DK0153065XZA
		Porz. Schwarz/Messing Altgrau - Black porc./Old silver	069-411-000-085	1A069DK0153085XZA
		Porz. Champagne/Messing Rustik - Champagne Porc./Rustic	069-411-000-08E	1A069DK015308EXZA
		Porz. Champagne/Brüniert - Porc. Champagne/Bronzed	069-411-000-08N	1A069DK015308NXZA
	Fensterolive ovale Ros. 30x65 inklusive Reastergehäuse mit 35 mm vorstehendem Stift <i>Dreh Kipp on rose and 7x35 mm spindle (mechanism included)</i>	Porz. Weiß/Messing Altgrau - White porc./Old silver	069-411-200-054	1A069DK0153554XZA
		Porz. Champagne/Antik Braun - Champagne porc./Antique	069-411-200-059	1A069DK0153559XZA
		Porz. Weiß/Antik Braun - White Porc./Antique	694-112-000-65	1A069DK0153565XZA
		Porz. Schwarz/Messing Altgrau - Black porc./Old silver	069-411-200-085	1A069DK0153585XZA
		Porz. Champagne/Messing Rustik - Champagne Porc./Rustic	069-411-200-08E	1A069DK015358EXZA
		Porz. Champagne/Brüniert - Porc. Champagne/Bronzed	069-411-200-08N	1A069DK015358NXZA

*Rastergehäuse finden Sie auf Seite 419 / For mechanism please see page 419

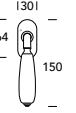
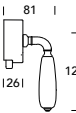
069DK075	Bezeichnung - Description	Farbe - Finishes	Alte art. nr - Old code	1 Stück - Piece
  	Fensterolive mit Druckknopf Ros. 30x64 inklusive Rastergehäuse mit 30 mm vorstehendem Stift Dreh Kipp with push button on rose (mechanism included) and 7x30 mm spindle (mechanism included)	Porz. Weiß/Messing Altgrau - White porc./Old silver	069-075-030-054	1A069DK0753054XZA
		Porz. Champagne/Antik Braun - Champagne porc./Antique	069-075-030-059	1A069DK0753059XZA
		Porz. Weiß/Antik Braun - White Porc./Antique	069-075-030-065	1A069DK0753065XZA
		Porz. Schwarz/Messing Altgrau - Black porc./Old silver	069-075-030-085	1A069DK0753085XZA
		Porz. Champagne/Messing Rustik - Champagne Porc./Rustic	069-075-030-08E	1A069DK075308EXZA
		Porz. Champagne/Brüniert - Porc. Champagne/Bronzed	069-075-030-08N	1A069DK075308NXZA
	Fensterolive mit Druckknopf Ros. 30x64 inklusive Reastergehäuse mit 35 mm vorstehendem Stift Dreh Kipp with push button on rose (mechanism included) and 7x35 mm spindle (mechanism included)	Porz. Weiß/Messing Altgrau - White porc./Old silver	069-075-035-054	1A069DK0753554XZA
		Porz. Champagne/Antik Braun - Champagne porc./Antique	069-075-035-059	1A069DK0753559XZA
		Porz. Weiß/Antik Braun - White Porc./Antique	069-075-035-065	1A069DK0753565XZA
		Porz. Schwarz/Messing Altgrau - Black porc./Old silver	069-075-035-085	1A069DK0753585XZA
		Porz. Champagne/Messing Rustik - Champagne Porc./Rustic	069-075-035-08E	1A069DK075358EXZA
		Porz. Champagne/Brüniert - Porc. Champagne/Bronzed	069-075-035-08N	1A069DK075358NXZA
Fensterolive mit Druckknopf Ros. 30x64 mit 50 mm vorstehendem Stift Dreh Kipp with push button on rose (mechanism included) and 7x50 mm spindle	Porz. Weiß/Messing Altgrau - White porc./Old silver	069-075-050-054	1A069DK0755054XZA	
	Porz. Champagne/Antik Braun - Champagne porc./Antique	069-075-050-059	1A069DK0755059XZA	
	Porz. Weiß/Antik Braun - White Porc./Antique	069-075-050-065	1A069DK0755065XZA	
	Porz. Schwarz/Messing Altgrau - Black porc./Old silver	069-075-050-085	1A069DK0755085XZA	
	Porz. Champagne/Messing Rustik - Champagne Porc./Rustic	069-075-050-08E	1A069DK075508EXZA	
	Porz. Champagne/Brüniert - Porc. Champagne/Bronzed	069-075-050-08N	1A069DK075508NXZA	

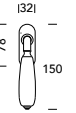
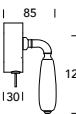
069DKC80	Bezeichnung - Description	Farbe - Finishes	Alte art. nr - Old code	1 Stück - Piece
  	Fensterolive "RC 2" zertifiziert Ros. 32x78 ohne Rastergehäuse (separat zu notieren*) DK with key RC2 certified on rose 32x78 without mechanism (to be ordered separately*)	Porz. Weiß/Messing Altgrau - White porc./Old silver	069-C80-10E-054	1A069DKC800054XZA
		Porz. Champagne/Antik Braun - Champagne porc./Antique	069-C80-10E-059	1A069DKC800059XZA
		Porz. Weiß/Antik Braun - White Porc./Antique	069-C80-10E-065	1A069DKC800065XZA
		Porz. Schwarz/Messing Altgrau - Black porc./Old silver	069-C80-10E-085	1A069DKC800085XZA
		Porz. Champagne/Messing Rustik - Champagne Porc./Rustic	069-C80-10E-08E	1A069DKC80008EXZA
		Porz. Champagne/Brüniert - Porc. Champagne/Bronzed	069-C80-10E-08N	1A069DKC80008NXZA
	Fensterolive "RC 2" zertifiziert Ros. 32x78 inklusive Rastergehäuse mit 30 mm vorstehendem Stift DK with key RC2 certified on rose 32x78 and 7x30 mm spindle (mechanism included)	Porz. Weiß/Messing Altgrau - White porc./Old silver	069-C80-00E-054	1A069DKC803054XZA
		Porz. Champagne/Antik Braun - Champagne porc./Antique	069-C80-00E-059	1A069DKC803059XZA
		Porz. Weiß/Antik Braun - White Porc./Antique	069-C80-00E-065	1A069DKC803065XZA
		Porz. Schwarz/Messing Altgrau - Black porc./Old silver	069-C80-00E-085	1A069DKC803085XZA
		Porz. Champagne/Messing Rustik - Champagne Porc./Rustic	069-C80-00E-08E	1A069DKC80308EXZA
		Porz. Champagne/Brüniert - Porc. Champagne/Bronzed	069-C80-00E-08N	1A069DKC80308NXZA
Fensterolive "RC 2" zertifiziert Ros. 32x78 inklusive Reastergehäuse mit 35 mm vorstehendem Stift DK with key RC2 certified on rose 32x78 and 7x35 mm spindle (mechanism included)	Porz. Weiß/Messing Altgrau - White porc./Old silver	069-C80-20E-054	1A069DKC803554XZA	
	Porz. Champagne/Antik Braun - Champagne porc./Antique	069-C80-20E-059	1A069DKC803559XZA	
	Porz. Weiß/Antik Braun - White Porc./Antique	069-C80-20E-065	1A069DKC803565XZA	
	Porz. Schwarz/Messing Altgrau - Black porc./Old silver	069-C80-20E-085	1A069DKC803585XZA	
	Porz. Champagne/Messing Rustik - Champagne Porc./Rustic	069-C80-20E-08E	1A069DKC80358EXZA	
	Porz. Champagne/Brüniert - Porc. Champagne/Bronzed	069-C80-20E-08N	1A069DKC80358NXZA	

*Rastergehäuse finden Sie auf Seite 419 / For mechanism please see page 419

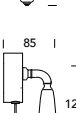
069DKT80	Bezeichnung - Description	Farbe - Finishes	Alte art. nr - Old code	1 Stück - Piece
  	Fensterolive mit TBT Funktion Ros. 32x78 ohne Rastergehäuse (separat zu notieren*) Dreh Kipp with key on rose 32x78 with TBT function without mechanism (to be ordered separately*)	Porz. Weiß/Messing Altgrau - White porc./Old silver	069-T80-10E-054	1A069DKT800054XZA
		Porz. Champagne/Antik Braun - Champagne porc./Antique	069-T80-10E-059	1A069DKT800059XZA
		Porz. Weiß/Antik Braun - White Porc./Antique	069-T80-10E-065	1A069DKT800065XZA
		Porz. Schwarz/Messing Altgrau - Black porc./Old silver	069-T80-10E-085	1A069DKT800085XZA
		Porz. Champagne/Messing Rustik - Champagne Porc./Rustic	069-T80-10E-08E	1A069DKT80008EXZA
		Porz. Champagne/Brüniert - Porc. Champagne/Bronzed	069-T80-10E-08N	1A069DKT80008NXZA
	Fensterolive mit TBT Funktion Ros. 32x78 inklusive Rastergehäuse mit 30 mm vorstehendem Stift Dreh Kipp with key on rose 32x78 with TBT function and 7x30 mm spindle (mechanism included)	Porz. Weiß/Messing Altgrau - White porc./Old silver	069-T80-00E-054	1A069DKT803054XZA
		Porz. Champagne/Antik Braun - Champagne porc./Antique	069-T80-00E-059	1A069DKT803059XZA
		Porz. Weiß/Antik Braun - White Porc./Antique	069-T80-00E-065	1A069DKT803065XZA
		Porz. Schwarz/Messing Altgrau - Black porc./Old silver	069-T80-00E-085	1A069DKT803085XZA
		Porz. Champagne/Messing Rustik - Champagne Porc./Rustic	069-T80-00E-08E	1A069DKT80308EXZA
		Porz. Champagne/Brüniert - Porc. Champagne/Bronzed	069-T80-00E-08N	1A069DKT80308NXZA
Fensterolive mit TBT Funktion Ros. 32x78 inklusive Reastergehäuse mit 35 mm vorstehendem Stift Dreh Kipp with key on rose 32x78 with TBT function and 7x35 mm spindle (mechanism included)	Porz. Weiß/Messing Altgrau - White porc./Old silver	069-T80-20E-054	1A069DKT803554XZA	
	Porz. Champagne/Antik Braun - Champagne porc./Antique	069-T80-20E-059	1A069DKT803559XZA	
	Porz. Weiß/Antik Braun - White Porc./Antique	069-T80-20E-065	1A069DKT803565XZA	
	Porz. Schwarz/Messing Altgrau - Black porc./Old silver	069-T80-20E-085	1A069DKT803585XZA	
	Porz. Champagne/Messing Rustik - Champagne Porc./Rustic	069-T80-20E-08E	1A069DKT80358EXZA	
	Porz. Champagne/Brüniert - Porc. Champagne/Bronzed	069-T80-20E-08N	1A069DKT80358NXZA	

*Rastergehäuse finden Sie auf Seite 419 / For mechanism please see page 419

Claudia 101

MESSING - BRASS

Datenblatt
Datasheet



05
Chrom
Polished chrome



46
Ultra Messing
PVD Gold

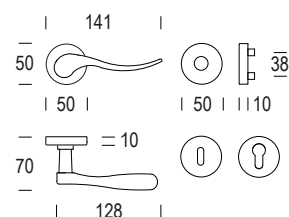

TÜRDRÜCKERGARNITUREN



101MRD17

WECHSELGARNITUREN



101PMD05

WC GARNITUREN



101RGD17

FENSTERGRIFFE

















101DK015



101DKC80



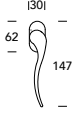
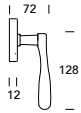

101DKT80

101MRD17	Bezeichnung - Description	Farbe - Finishes	Alte art. nr - Old code	1 Stück - Piece
 	Doppelte Bezeichnung Ø50x10 mm Schlüsselloch <i>Pair lever handle on rose Ø50x10 mm key hole</i>	Chrom - Polished chrome	101-D17-031-000	1A101MRD173105ZZA
		Ultra Messing - PVD Gold 	101-D17-031-367	1A101MRD173146ZZA
 	Doppelte Bezeichnung Ø50x10 mm PZ <i>Pair lever handle on rose Ø50x10 mm euro profile cylinder hole</i>	Chrom - Polished chrome	101-D17-032-000	1A101MRD173205ZZA
		Ultra Messing - PVD Gold 	101-D17-032-367	1A101MRD173246ZZA
 	WE-Garnitur mit Knopf E56 PZ rechtszeigend <i>Entrance set lever handle / knob E56 Euro profile cylinder hole (right hand)</i>	Chrom - Polished chrome	101-D17-R00-000	1A101PMD053205JZA
		Ultra Messing - PVD Gold 	101-D17-R00-367	1A101PMD053246JZA
 	WE-Garnitur mit Knopf E56 PZ linkszeigend <i>Entrance set lever handle / knob E56 Euro profile cylinder hole (left hand)</i>	Chrom - Polished chrome	101-D17-L00-000	1A101PMD053205LZA
		Ultra Messing - PVD Gold 	101-D17-L00-367	1A101PMD053246LZA
 	WC-Garnitur mit Rosetten Ø50x10 mm mit Riegel 512 und Schlitzschraube 8mm VK <i>Lever handle on rose Ø50x10 mm with 512 turn and release with 8 mm spindle</i>	Chrom - Polished chrome	101-D17-900-000	1A101RGD174205ZZA
		Ultra Messing - PVD Gold 	101-D17-900-367	1A101RGD174246ZZA

101DK015	Bezeichnung - Description	Farbe - Finishes	Alte art. nr - Old code	1 Stück - Piece
  	Fensterlive ovale Ros. 30x65 ohne Rastergehäuse (separat zu notieren*) <i>Dreh Kipp on rose without mechanism (to be ordered separately*) (right hand)</i>	Chrom - Polished chrome Ultra Messing - PVD Gold	101-434-110-000 101-434-110-367	1A101DK0150005DZA 1A101DK0150046DZA
	Fensterlive ovale Ros. 30x65 ohne Rastergehäuse (separat zu notieren*) <i>Dreh Kipp on rose without mechanism (to be ordered separately*) (left hand)</i>	Chrom - Polished chrome Ultra Messing - PVD Gold	101-433-110-000 101-433-110-367	1A101DK0150005SZA 1A101DK0150046SZA
	Fensterlive ovale Ros. 30x65 inklusive Rastergehäuse mit 30 mm vorstehendem Stift <i>Dreh Kipp on rose and 7x30 mm spindle (mechanism included) (right hand)</i>	Chrom - Polished chrome Ultra Messing - PVD Gold	101-434-000-000 101-434-000-367	1A101DK0153005DZA 1A101DK0153046DZA
	Fensterlive ovale Ros. 30x65 inklusive Rastergehäuse mit 30 mm vorstehendem Stift <i>Dreh Kipp on rose and 7x30 mm spindle (mechanism included) (left hand)</i>	Chrom - Polished chrome Ultra Messing - PVD Gold	101-433-000-000 101-433-000-367	1A101DK0153005SZA 1A101DK0153046SZA
	Fensterlive ovale Ros. 30x65 inklusive Rastergehäuse mit 35 mm vorstehendem Stift <i>Dreh Kipp on rose and 7x35 mm spindle (mechanism included) (right hand)</i>	Chrom - Polished chrome Ultra Messing - PVD Gold	101-434-200-000 101-434-200-367	1A101DK0153505DZA 1A101DK0153546DZA
	Fensterlive ovale Ros. 30x65 inklusive Rastergehäuse mit 35 mm vorstehendem Stift <i>Dreh Kipp on rose and 7x35 mm spindle (mechanism included) (left hand)</i>	Chrom - Polished chrome Ultra Messing - PVD Gold	101-433-200-000 101-433-200-367	1A101DK0153505SZA 1A101DK0153546SZA

*Rastergehäuse finden Sie auf Seite 419 / For mechanism please see page 419

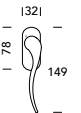
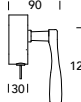
101DKC80	Bezeichnung - Description	Farbe - Finishes	Alte art. nr - Old code	1 Stück - Piece
   	<p>Fensterolive "RC 2" zertifiziert Ros. 32x78 ohne Rastergehäuse (separat zu notieren*)</p> <p><i>DK with key RC2 certified on rose 32x78 without mechanism (to be ordered separately*) (right hand)</i></p>	<p>Chrom - Polished chrome Ultra Messing - PVD Gold</p>	<p>101-C80-1RE-000 101-C80-1RE-367</p>	<p>1A101DKC800005DZA 1A101DKC800046DZA</p>
	<p>Fensterolive "RC 2" zertifiziert Ros. 32x78 ohne Rastergehäuse (separat zu notieren*)</p> <p><i>DK with key RC2 certified on rose 32x78 without mechanism (to be ordered separately*) (left hand)</i></p>	<p>Chrom - Polished chrome Ultra Messing - PVD Gold</p>	<p>101-C80-1LE-000 101-C80-1LE-367</p>	<p>1A101DKC800005SZA 1A101DKC800046SZA</p>
	<p>Fensterolive "RC 2" zertifiziert Ros. 32x78 inklusive Rastergehäuse mit 30 mm vorstehendem Stift</p> <p><i>DK with key RC2 certified on rose 32x78 and 7x30 mm spindle (mechanism included) (right hand)</i></p>	<p>Chrom - Polished chrome Ultra Messing - PVD Gold</p>	<p>101-C80-0RE-000 101-C80-0RE-367</p>	<p>1A101DKC803005DZA 1A101DKC803046DZA</p>
	<p>Fensterolive "RC 2" zertifiziert Ros. 32x78 inklusive Rastergehäuse mit 30 mm vorstehendem Stift</p> <p><i>DK with key RC2 certified on rose 32x78 and 7x30 mm spindle (mechanism included) (left hand)</i></p>	<p>Chrom - Polished chrome Ultra Messing - PVD Gold</p>	<p>101-C80-0LE-000 101-C80-0LE-367</p>	<p>1A101DKC803005SZA 1A101DKC803046SZA</p>
	<p>Fensterolive "RC 2" zertifiziert Ros. 32x78 inklusive Rastergehäuse mit 35 mm vorstehendem Stift</p> <p><i>DK with key RC2 certified on rose 32x78 and 7x35 mm spindle (mechanism included) (right hand)</i></p>	<p>Chrom - Polished chrome Ultra Messing - PVD Gold</p>	<p>101-C80-2RE-000 101-C80-2RE-367</p>	<p>1A101DKC803505DZA 1A101DKC803546DZA</p>
	<p>Fensterolive "RC 2" zertifiziert Ros. 32x78 inklusive Rastergehäuse mit 35 mm vorstehendem Stift</p> <p><i>DK with key RC2 certified on rose 32x78 and 7x35 mm spindle (mechanism included) (left hand)</i></p>	<p>Chrom - Polished chrome Ultra Messing - PVD Gold</p>	<p>101-C80-2LE-000 101-C80-2LE-367</p>	<p>1A101DKC803505SZA 1A101DKC803546SZA</p>

*Rastergehäuse finden Sie auf Seite 419 / For mechanism please see page 419

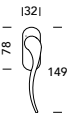
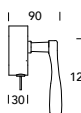
101DKT80	Bezeichnung - Description	Farbe - Finishes	Alte art. nr - Old code	1 Stück - Piece
  	Fensterolive mit TBT Funktion Ros. 32x78 ohne Rastergehäuse (separat zu notieren*) <i>Dreh Kipp with key on rose 32x78 with TBT function without mechanism (to be ordered separately*) (right hand)</i>	Chrom - Polished chrome Ultra Messing - PVD Gold	101-T80-1RE-000 101-T80-1RE-367	1A101DKT800005DZA 1A101DKT800046DZA
	Fensterolive mit TBT Funktion Ros. 32x78 ohne Rastergehäuse (separat zu notieren*) <i>Dreh Kipp with key on rose 32x78 with TBT function without mechanism (to be ordered separately*) (left hand)</i>	Chrom - Polished chrome Ultra Messing - PVD Gold	101-T80-1LE-000 101-T80-1LE-367	1A101DKT800005SZA 1A101DKT800046SZA
	Fensterolive mit TBT Funktion Ros. 32x78 inklusive Rastergehäuse mit 30 mm vorstehendem Stift <i>Dreh Kipp with key on rose 32x78 with TBT function and 7x30 mm spindle (mechanism included) (right hand)</i>	Chrom - Polished chrome Ultra Messing - PVD Gold	101-T80-0RE-000 101-T80-0RE-367	1A101DKT803005DZA 1A101DKT803046DZA
	Fensterolive mit TBT Funktion Ros. 32x78 inklusive Rastergehäuse mit 30 mm vorstehendem Stift <i>Dreh Kipp with key on rose 32x78 with TBT function and 7x30 mm spindle (mechanism included) (left hand)</i>	Chrom - Polished chrome Ultra Messing - PVD Gold	101-T80-0LE-000 101-T80-0LE-367	1A101DKT803005SZA 1A101DKT803046SZA
	Fensterolive mit TBT Funktion Ros. 32x78 inklusive Reastergehäuse mit 35 mm vorstehendem Stift <i>Dreh Kipp with key on rose 32x78 with TBT function and 7x35 mm spindle (mechanism included) (right hand)</i>	Chrom - Polished chrome Ultra Messing - PVD Gold	101-T80-2RE-000 101-T80-2RE-367	1A101DKT803505DZA 1A101DKT803546DZA
	Fensterolive mit TBT Funktion Ros. 32x78 inklusive Reastergehäuse mit 35 mm vorstehendem Stift <i>Dreh Kipp with key on rose 32x78 with TBT function and 7x35 mm spindle (mechanism included) (left hand)</i>	Chrom - Polished chrome Ultra Messing - PVD Gold	101-T80-2LE-000 101-T80-2LE-367	1A101DKT803505SZA 1A101DKT803546SZA

*Rastergehäuse finden Sie auf Seite 419 / For mechanism please see page 419



1M
Messing Rustik
Rustic brass



47
Messing Alterau
Old silver



8F
Messing Brüniert 800
Matt brushed bronzed

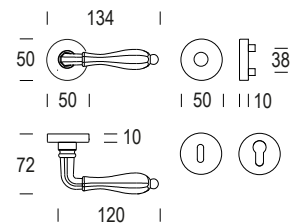
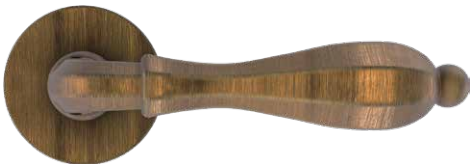

TÜRDRÜCKERGARNITUREN



800MRD17



800MR009



800MP040

WECHSELGARNITUREN



800PMD01



800PM011

WC GARNITUREN



800RGD17



800RG009



800PG040

FENSTERGRIFFE



800DK015































800DK075



800DKC80



800DKT80

800MRD17	Bezeichnung - Description	Farbe - Finishes	Alte art. nr - Old code	1 Stück - Piece
 	Doppelte Bezeichnung Ø50x10 mm Schlüssellochung <i>Pair lever handle on rose Ø50x10 mm key hole</i>	Messing Rustik - Rustic brass	80C-D17-031-01M	1A800MRD17311MZZA
		Messing Altgrau - Old silver 	80C-D17-031-047	1A800MRD173147ZZA
		Messing Brüniert 800 - Matt brushed bronzed 	80C-D17-031-08F	1A800MRD17318FZZA
 	Doppelte Bezeichnung Ø50x10 mm PZ <i>Pair lever handle on rose Ø50x10 mm euro profile cylinder hole</i>	Messing Rustik - Rustic brass	80C-D17-032-01M	1A800MRD17321MZZA
		Messing Altgrau - Old silver 	80C-D17-032-047	1A800MRD173247ZZA
		Messing Brüniert 800 - Matt brushed bronzed 	80C-D17-032-08F	1A800MRD17328FZZA
 	WE-Garnitur mit Knopf J01 (420) PZ beidseitig verwendbar <i>Entrance set lever handle / knob J01 (420) Euro profile cylinder hole (LH/RH)</i>	Messing Rustik - Rustic brass	80C-D17-Y01-01M	1A800PMD01321MYZA
		Messing Altgrau - Old silver 	80C-D17-Y01-047	1A800PMD013247YZA
		Messing Brüniert 800 - Matt brushed bronzed 	80C-D17-Y01-08F	1A800PMD01328FYZA
 	WC-Garnitur mit Rosetten Ø50x10 mm mit Riegel 512 und Schlitzschraube 8mm VK <i>Lever handle on rose Ø50x10 mm with 512 turn and release with 8 mm spindle</i>	Messing Rustik - Rustic brass	80C-D17-900-01M	1A800RGD17421MZZA
		Messing Altgrau - Old silver 	80C-D17-900-047	1A800RGD174247ZZA
		Messing Brüniert 800 - Matt brushed bronzed 	80C-D17-900-08F	1A800RGD17428FZZA
 	Doppelte Bezeichnung 32x62x10 mm Schlüssellochung <i>Pair lever handle on rose 32x62x10 mm key hole</i>	Messing Rustik - Rustic brass	80C-009-031-01M	1A800MR009311MDZA
		Messing Altgrau - Old silver 	80C-009-031-047	1A800MR0093147DZA
		Messing Brüniert 800 - Matt brushed bronzed 	80C-009-031-08F	1A800MR009318FDZA
 	Doppelte Bezeichnung 32x62x10 mm PZ <i>Pair lever handle on rose 32x62x10 mm euro profile cylinder hole</i>	Messing Rustik - Rustic brass	80C-009-032-01M	1A800MR009321MDZA
		Messing Altgrau - Old silver 	80C-009-032-047	1A800MR0093247DZA
		Messing Brüniert 800 - Matt brushed bronzed 	80C-009-032-08F	1A800MR009328FDZA
 	WC-Garnitur mit ovale Rosetten 32x62x10 mm mit Riegel 512 und Schlitzschraube 8mm VK <i>Lever handle on oval rose 32x62x10 mm with 512 turn and release with 8 mm spindle</i>	Messing Rustik - Rustic brass	80C-009-900-01M	1A800RG009421MDZA
		Messing Altgrau - Old silver 	80C-009-900-047	1A800RG0094247DZA
		Messing Brüniert 800 - Matt brushed bronzed 	80C-009-900-08F	1A800RG009428FDZA

800MP040	Bezeichnung - Description	Farbe - Finishes	Alte art. nr - Old code	1 Stück - Piece
	ZT-Garnitur mit Schild mit IB 72 mm <i>Pair lever handle on plate with standard key hole 72mm</i>	Messing Rustik - Rustic brass	80C-040-006-01M	1A800MP040061MDZA
		Messing Altgrau - Old silver	80C-040-006-047	1A800MP0400647DZA
		Messing Brüniert 800 - Matt brushed bronzed	80C-040-006-08F	1A800MP040068FDZA
	ZT-Garnitur mit Schild mit PZ 72 mm <i>Pair lever handle on plate with Euro Profile cylinder hole 72mm</i>	Messing Rustik - Rustic brass	80C-040-013-01M	1A800MP040131MDZA
		Messing Altgrau - Old silver	80C-040-013-047	1A800MP0401347DZA
		Messing Brüniert 800 - Matt brushed bronzed	80C-040-013-08F	1A800MP040138FDZA
	WE-Garnitur mit Knopf E56 72 mm PZ rechtszeigend <i>Entrance set lever handle / knob E56 with Euro Profile cylinder hole 72mm (right hand)</i>	Messing Rustik - Rustic brass	80C-040-D13-01M	1A800PM011131MJZA
		Messing Altgrau - Old silver	80C-040-D13-047	1A800PM0111347JZA
		Messing Brüniert 800 - Matt brushed bronzed	80C-040-D13-08F	1A800PM011138FJZA
	WE-Garnitur mit Knopf E56 72 mm PZ linkszeigend <i>Entrance set lever handle / knob E56 with Euro Profile cylinder hole 72mm (left hand)</i>	Messing Rustik - Rustic brass	80C-040-S13-01M	1A800PM011131MLZA
		Messing Altgrau - Old silver	80C-040-S13-047	1A800PM0111347LZA
		Messing Brüniert 800 - Matt brushed bronzed	80C-040-S13-08F	1A800PM011138FLZA
	WC-Garnitur mit Schild 40x246 mm, Riegel 512 & Schlitzschraube 8mm VK <i>Pair lever handle on plate with 512 turn and release (8mm WC spindle)</i>	Messing Rustik - Rustic brass	80C-040-600-01M	1A800PG040241MVZA
		Messing Altgrau - Old silver	80C-040-600-047	1A800PG0402447VZA
		Messing Brüniert 800 - Matt brushed bronzed	80C-040-600-08F	1A800PG040248FVZA

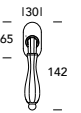
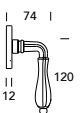
800DK015	Bezeichnung - Description	Farbe - Finishes	Alte art. nr - Old code	1 Stück - Piece
  	Fensterolive ovale Ros. 30x65 ohne Rastergehäuse (separat zu notieren*) Dreh Kipp on rose without mechanism (to be ordered separately*)	Messing Rustik - Rustic brass	80C-411-110-01M	1A800DK015001MXZA
		Messing Altgrau - Old silver	80C-411-110-047	1A800DK0150047XZA
		Messing Brüniert 800 - Matt brushed bronzed	80C-411-110-08F	1A800DK015008FXZA
	Fensterolive ovale Ros. 30x65 inklusive Rastergehäuse mit 30 mm vorstehendem Stift Dreh Kipp on rose and 7x30 mm spindle (mechanism included)	Messing Rustik - Rustic brass	80C-411-000-01M	1A800DK015301MXZA
		Messing Altgrau - Old silver	80C-411-000-047	1A800DK0153047XZA
		Messing Brüniert 800 - Matt brushed bronzed	80C-411-000-08F	1A800DK015308FXZA
	Fensterolive ovale Ros. 30x65 inklusive Reastergehäuse mit 35 mm vorstehendem Stift Dreh Kipp on rose and 7x35 mm spindle (mechanism included)	Messing Rustik - Rustic brass	80C-411-200-01M	1A800DK015351MXZA
		Messing Altgrau - Old silver	80C-411-200-047	1A800DK0153547XZA
		Messing Brüniert 800 - Matt brushed bronzed	80C-411-200-08F	1A800DK015358FXZA

*Rastergehäuse finden Sie auf Seite 419 / For mechanism please see page 419

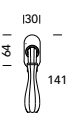
800DK075	Bezeichnung - Description	Farbe - Finishes	Alte art. nr - Old code	1 Stück - Piece
  	Fensterolive mit Druckknopf Ros. 30x64 inklusive Rastergehäuse mit 30 mm vorstehendem Stift Dreh Kipp with push button on rose (mechanism included) and 7x30 mm spindle (mechanism included)	Messing Rustik - Rustic brass	80C-075-030-01M	1A800DK075301MXZA
		Messing Altgrau - Old silver	80C-075-030-047	1A800DK0753047XZA
		Messing Brüniert 800 - Matt brushed bronzed	80C-075-030-08F	1A800DK075308FXZA
	Fensterolive mit Druckknopf Ros. 30x64 inklusive Reastergehäuse mit 35 mm vorstehendem Stift Dreh Kipp with push button on rose (mechanism included) and 7x35 mm spindle (mechanism included)	Messing Rustik - Rustic brass	80C-075-035-01M	1A800DK075351MXZA
		Messing Altgrau - Old silver	80C-075-035-047	1A800DK0753547XZA
		Messing Brüniert 800 - Matt brushed bronzed	80C-075-035-08F	1A800DK075358FXZA
	Fensterolive mit Druckknopf Ros. 30x64 mit 50 mm vorstehendem Stift Dreh Kipp with push button on rose (mechanism included) and 7x50 mm spindle	Messing Rustik - Rustic brass	80C-075-050-01M	1A800DK075501MXZA
		Messing Altgrau - Old silver	80C-075-050-047	1A800DK0755047XZA
		Messing Brüniert 800 - Matt brushed bronzed	80C-075-050-08F	1A800DK075508FXZA

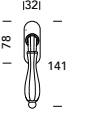
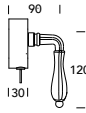
800DKC80	Bezeichnung - Description	Farbe - Finishes	Alte art. nr - Old code	1 Stück - Piece
  	Fensterolive "RC 2" zertifiziert Ros. 32x78 ohne Rastergehäuse (separat zu notieren*) DK with key RC2 certified on rose 32x78 without mechanism (to be ordered separately*)	Messing Rustik - Rustic brass	80C-C80-10E-01M	1A800DKC80001MXZA
		Messing Altgrau - Old silver	80C-C80-10E-047	1A800DKC800047XZA
		Messing Brüniert 800 - Matt brushed bronzed	80C-C80-10E-08F	1A800DKC80008FXZA
	Fensterolive "RC 2" zertifiziert Ros. 32x78 inklusive Rastergehäuse mit 30 mm vorstehendem Stift DK with key RC2 certified on rose 32x78 and 7x30 mm spindle (mechanism included)	Messing Rustik - Rustic brass	80C-C80-00E-01M	1A800DKC80301MXZA
		Messing Altgrau - Old silver	80C-C80-00E-047	1A800DKC803047XZA
		Messing Brüniert 800 - Matt brushed bronzed	80C-C80-00E-08F	1A800DKC80308FXZA
	Fensterolive "RC 2" zertifiziert Ros. 32x78 inklusive Rastergehäuse mit 35 mm vorstehendem Stift DK with key RC2 certified on rose 32x78 and 7x35 mm spindle (mechanism included)	Messing Rustik - Rustic brass	80C-C80-20E-01M	1A800DKC80351MXZA
		Messing Altgrau - Old silver	80C-C80-20E-047	1A800DKC803547XZA
		Messing Brüniert 800 - Matt brushed bronzed	80C-C80-20E-08F	1A800DKC80358FXZA

*Rastergehäuse finden Sie auf Seite 419 / For mechanism please see page 419

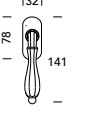
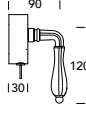
800DKT80	Bezeichnung - Description	Farbe - Finishes	Alte art. nr - Old code	1 Stück - Piece
  	Fensterolive mit TBT Funktion Ros. 32x78 ohne Rastergehäuse (separat zu notieren*) Dreh Kipp with key on rose 32x78 with TBT function without mechanism (to be ordered separately*)	Messing Rustik - Rustic brass	80C-T80-10E-01M	1A800DKT80001MXZA
		Messing Altgrau - Old silver	80C-T80-10E-047	1A800DKT800047XZA
		Messing Brüniert 800 - Matt brushed bronzed	80C-T80-10E-08F	1A800DKT80008FXZA
	Fensterolive mit TBT Funktion Ros. 32x78 inklusive Rastergehäuse mit 30 mm vorstehendem Stift Dreh Kipp with key on rose 32x78 with TBT function and 7x30 mm spindle (mechanism included)	Messing Rustik - Rustic brass	80C-T80-00E-01M	1A800DKT80301MXZA
		Messing Altgrau - Old silver	80C-T80-00E-047	1A800DKT803047XZA
		Messing Brüniert 800 - Matt brushed bronzed	80C-T80-00E-08F	1A800DKT80308FXZA
	Fensterolive mit TBT Funktion Ros. 32x78 inklusive Rastergehäuse mit 35 mm vorstehendem Stift Dreh Kipp with key on rose 32x78 with TBT function and 7x35 mm spindle (mechanism included)	Messing Rustik - Rustic brass	80C-T80-20E-01M	1A800DKT80351MXZA
		Messing Altgrau - Old silver	80C-T80-20E-047	1A800DKT803547XZA
		Messing Brüniert 800 - Matt brushed bronzed	80C-T80-20E-08F	1A800DKT80358FXZA

*Rastergehäuse finden Sie auf Seite 419 / For mechanism please see page 419

Essence Eckig 260

MESSING - BRASS

Datenblatt
Datasheet

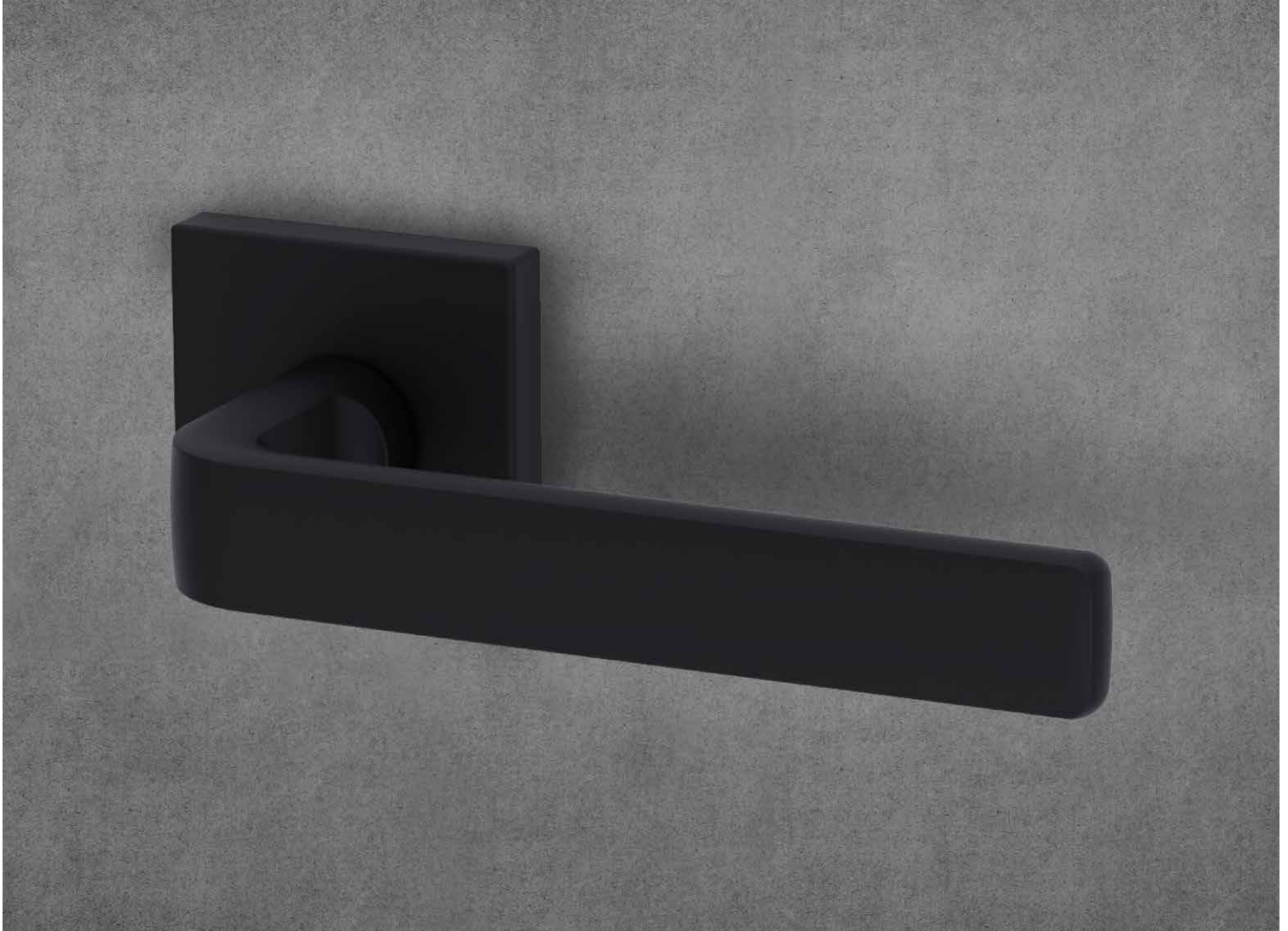

18
Schwarz RAL 9005
Matt black RAL 9005



31
Mattnickel
Satin nickel

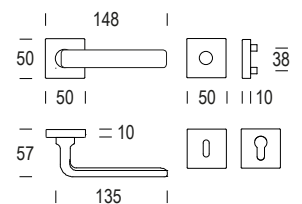

TÜRDRÜCKERGARNITUREN



260MRQD7



260MRQ09

WECHSELGARNITUREN



260PMD03

WC GARNITUREN



260RQQD7



260RQQ09

FENSTERGRIFFE



260DKQ15







260DKQ75





260DKC81



260DKT81

260MRQD7	Bezeichnung - Description	Farbe - Finishes	Alte art. nr - Old code	1 Stück - Piece
 	Doppelte Bezeichnung 50x50x10 mm Schlüssellochung <i>Pair lever handle on rose 50x50x10 mm key hole</i>	Schwarz RAL 9005 - <i>Matt black RAL 9005</i>	260-QD7-031-180	1A260MRQD73118ZZA
		Mattnickel - <i>Satin nickel</i>	-	1A260MRQD73131ZZA
 	Doppelte Bezeichnung 50x50x10 mm PZ <i>Pair lever handle on rose 50x50x10 mm euro profile cylinder hole</i>	Schwarz RAL 9005 - <i>Matt black RAL 9005</i>	260-QD7-032-180	1A260MRQD73218ZZA
		Mattnickel - <i>Satin nickel</i>	-	1A260MRQD73231ZZA
260PMD03	Bezeichnung - Description	Farbe - Finishes	Alte art. nr - Old code	1 Stück - Piece
 	WE-Garnitur mit Knopf J03 (373) PZ beidseitig verwendbar <i>Entrance set lever handle / knob J03 (373) Euro profile cylinder hole (LH/RH)</i>	Schwarz RAL 9005 - <i>Matt black RAL 9005</i>	260-QD7-Y03-180	1A260PMD033218YZA
		Mattnickel - <i>Satin nickel</i>	-	1A260PMD033231YZA
260RQQD7	Bezeichnung - Description	Farbe - Finishes	Alte art. nr - Old code	1 Stück - Piece
 	WC-Garnitur mit quadratische Rosette 50x50x10 mm mit Riegel 124 und Schlitzschraube 8mm VK <i>Lever handle on rose 50x50x10 mm with 124 turn and release with 8 mm spindle</i>	Schwarz RAL 9005 - <i>Matt black RAL 9005</i>	260-QD7-900-180	1A260RQQD74218ZZA
		Mattnickel - <i>Satin nickel</i>	-	1A260RQQD74231XZA

260MRQ09	Bezeichnung - Description	Farbe - Finishes	Alte art. nr - Old code	1 Stück - Piece
	Doppelte Bezeichnung 32x62x10 mm Schlüsselochung <i>Pair lever handle on rose 32x62x10 mm key hole</i>	Schwarz RAL 9005 - <i>Matt black RAL 9005</i> Mattnickel - <i>Satin nickel</i>	260-Q09-031-180 -	1A260MRQ093118DZA 1A260MRQ093131DZA
	Doppelte Bezeichnung 32x62x10 mm PZ <i>Pair lever handle on rose 32x62x10 mm euro profile cylinder hole</i>	Schwarz RAL 9005 - <i>Matt black RAL 9005</i> Mattnickel - <i>Satin nickel</i>	260-Q09-032-180 -	1A260MRQ093218DZA 1A260MRQ093231DZA
	WC-Garnitur mit rechteckige Rosetten 32x62x10 mm mit Riegel 124 und Schlitzschraube 8mm VK <i>Lever handle on rectangular rose 32x62x10 mm with 124 turn and release with 8 mm spindle</i>	Schwarz RAL 9005 - <i>Matt black RAL 9005</i> Mattnickel - <i>Satin nickel</i>	260-Q09-900-180 -	1A260RQQ094218DZA 1A260RQQ094231DZA

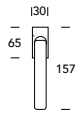
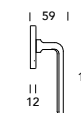
260DKQ15	Bezeichnung - Description	Farbe - Finishes	Alte art. nr - Old code	1 Stück - Piece
  	Fensterlive rechteckige Ros. 30x65 ohne Rastergehäuse (separat zu notieren*) <i>Dreh Kipp on rose without mechanism (to be ordered separately*)</i>	Schwarz RAL 9005 - <i>Matt black RAL 9005</i> Mattnickel - <i>Satin nickel</i>	260-511-110-180 -	1A260DKQ150018XZA 1A260DKQ150031XZA
	Fensterlive rechteckige Ros. 30x65 inklusive Rastergehäuse mit 30 mm vorstehendem Stift <i>Dreh Kipp on rose and 7x30 mm spindle (mechanism included)</i>	Schwarz RAL 9005 - <i>Matt black RAL 9005</i> Mattnickel - <i>Satin nickel</i>	260-511-000-180 -	1A260DKQ153018XZA 1A260DKQ153031XZA
	Fensterlive rechteckige Ros. 30x65 inklusive Reastergehäuse mit 35 mm vorstehendem Stift <i>Dreh Kipp on rose and 7x35 mm spindle (mechanism included)</i>	Schwarz RAL 9005 - <i>Matt black RAL 9005</i> Mattnickel - <i>Satin nickel</i>	260-511-200-180 -	1A260DKQ153518XZA 1A260DKQ153531XZA

*Rastergehäuse finden Sie auf Seite 419 / For mechanism please see page 419

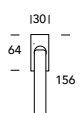
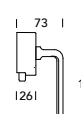
260DKQ75	Bezeichnung - Description	Farbe - Finishes	Alte art. nr - Old code	1 Stück - Piece
  	Fensterlive mit Druckknopf Ros. 30x65 inklusive Rastergehäuse mit 30 mm vorstehendem Stift <i>Dreh Kipp with push button on rose (mechanism included) and 7x30 mm spindle (mechanism included)</i>	Schwarz RAL 9005 - <i>Matt black RAL 9005</i> Mattnickel - <i>Satin nickel</i>	260-Q75-030-180 -	1A260DKQ753018XZA 1A260DKQ753031XZA
	Fensterlive mit Druckknopf Ros. 30x65 inklusive Reastergehäuse mit 35 mm vorstehendem Stift <i>Dreh Kipp with push button on rose (mechanism included) and 7x35 mm spindle (mechanism included)</i>	Schwarz RAL 9005 - <i>Matt black RAL 9005</i> Mattnickel - <i>Satin nickel</i>	260-Q75-035-180 -	1A260DKQ753518XZA 1A260DKQ753531XZA
	Fensterlive mit Druckknopf Ros. 30x65 mit 50 mm vorstehendem Stift <i>Dreh Kipp with push button on rose (mechanism included) and 7x50 mm spindle</i>	Schwarz RAL 9005 - <i>Matt black RAL 9005</i> Mattnickel - <i>Satin nickel</i>	260-Q75-050-180 -	1A260DKQ755018XZA 1A260DKQ755031XZA

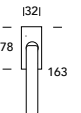
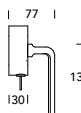
260DKC81	Bezeichnung - Description	Farbe - Finishes	Alte art. nr - Old code	1 Stück - Piece
  	Fensterolive "RC 2" zertifiziert Ros. 32x78 ohne Rastergehäuse (separat zu notieren*) <i>DK with key RC2 certified on rose 32x78 without mechanism (to be ordered separately*)</i>	Schwarz RAL 9005 - <i>Matt black RAL 9005</i> Mattnickel - <i>Satin nickel</i>	260-C81-10E-180 -	1A260DKC810018XZA 1A260DKC810031XZA
	Fensterolive "RC 2" zertifiziert Ros. 32x78 inklusive Rastergehäuse mit 30 mm vorstehendem Stift <i>DK with key RC2 certified on rose 32x78 and 7x30 mm spindle (mechanism included)</i>	Schwarz RAL 9005 - <i>Matt black RAL 9005</i> Mattnickel - <i>Satin nickel</i>	260-C81-00E-180 -	1A260DKC813018XZA 1A260DKC813031XZA
	Fensterolive "RC 2" zertifiziert Ros. 32x78 inklusive Rastergehäuse mit 35 mm vorstehendem Stift <i>DK with key RC2 certified on rose 32x78 and 7x35 mm spindle (mechanism included)</i>	Schwarz RAL 9005 - <i>Matt black RAL 9005</i> Mattnickel - <i>Satin nickel</i>	260-C81-20E-180 -	1A260DKC813518XZA 1A260DKC813531XZA
	*Rastergehäuse finden Sie auf Seite 419 / For mechanism please see page 419			

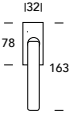
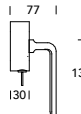
260DKT81	Bezeichnung - Description	Farbe - Finishes	Alte art. nr - Old code	1 Stück - Piece
  	Fensterolive mit TBT Funktion Ros. 32x78 ohne Rastergehäuse (separat zu notieren*) <i>Dreh Kipp with key on rose 32x78 with TBT function without mechanism (to be ordered separately*)</i>	Schwarz RAL 9005 - <i>Matt black RAL 9005</i> Mattnickel - <i>Satin nickel</i>	260-T81-10E-180 -	1A260DKT810018XZA 1A260DKT810031XZA
	Fensterolive mit TBT Funktion Ros. 32x78 inklusive Rastergehäuse mit 30 mm vorstehendem Stift <i>Dreh Kipp with key on rose 32x78 with TBT function and 7x30 mm spindle (mechanism included)</i>	Schwarz RAL 9005 - <i>Matt black RAL 9005</i> Mattnickel - <i>Satin nickel</i>	260-T81-00E-180 -	1A260DKT813018XZA 1A260DKT813031XZA
	Fensterolive mit TBT Funktion Ros. 32x78 inklusive Rastergehäuse mit 35 mm vorstehendem Stift <i>Dreh Kipp with key on rose 32x78 with TBT function and 7x35 mm spindle (mechanism included)</i>	Schwarz RAL 9005 - <i>Matt black RAL 9005</i> Mattnickel - <i>Satin nickel</i>	260-T81-20E-180 -	1A260DKT813518XZA 1A260DKT813531XZA
	*Rastergehäuse finden Sie auf Seite 419 / For mechanism please see page 419			

Essence Rund 260

MESSING - BRASS

Datenblatt
Datasheet



18
Schwarz RAL 9005
Matt black RAL 9005



31
Mattnickel
Satin nickel

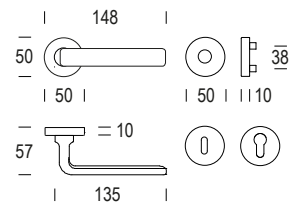

TÜRDRÜCKERGARNITUREN



260MRD17



260MR009

WECHSELGARNITUREN



260PMD01

GANZGLASTÜR BESCHLÄGE



R51SR

Seite 438 / page 438

WC GARNITUREN



260RGD17



260RG009

FENSTERGRIFFE



260DK015











260DK075









260DKC80



260DKT80

260MRD17	Bezeichnung - Description	Farbe - Finishes	Alte art. nr - Old code	1 Stück - Piece
 	Doppelte Bezeichnung Ø50x10 mm Schlüssellochung <i>Pair lever handle on rose Ø50x10 mm key hole</i>	Schwarz RAL 9005 - <i>Matt black RAL 9005</i>	260-D17-031-180	1A260MRD173118ZZA
		Mattnickel - <i>Satin nickel</i>	-	1A260MRD173131ZZA
 	Doppelte Bezeichnung Ø50x10 mm PZ <i>Pair lever handle on rose Ø50x10 mm euro profile cylinder hole</i>	Schwarz RAL 9005 - <i>Matt black RAL 9005</i>	260-D17-032-180	1A260MRD173218ZZA
		Mattnickel - <i>Satin nickel</i>	-	1A260MRD173231ZZA
 	WE-Garnitur mit Knopf J01 (420) PZ beidseitig verwendbar <i>Entrance set lever handle / knob J01 (420) Euro profile cylinder hole (LH/RH)</i>	Schwarz RAL 9005 - <i>Matt black RAL 9005</i>	260-D17-Y01-180	1A260PMD013218YZA
		Mattnickel - <i>Satin nickel</i>	-	1A260PMD013231YZA
 	WC-Garnitur mit Rosetten Ø50x10 mm mit Riegel 512 und Schlitzschraube 8mm VK <i>Lever handle on rose Ø50x10 mm with 512 turn and release with 8 mm spindle</i>	Schwarz RAL 9005 - <i>Matt black RAL 9005</i>	260-D17-900-180	1A260RGD174218ZZA
		Mattnickel - <i>Satin nickel</i>	-	1A260RGD174231ZZA

260MR009	Bezeichnung - Description	Farbe - Finishes	Alte art. nr - Old code	1 Stück - Piece
 	Doppelte Bezeichnung 32x62x10 mm Schlüssellochung <i>Pair lever handle on rose 32x62x10 mm key hole</i>	Schwarz RAL 9005 - <i>Matt black RAL 9005</i>	260-009-031-180	1A260MR0093118DZA
		Mattnickel - <i>Satin nickel</i>	-	1A260MR0093131DZA
 	Doppelte Bezeichnung 32x62x10 mm PZ <i>Pair lever handle on rose 32x62x10 mm euro profile cylinder hole</i>	Schwarz RAL 9005 - <i>Matt black RAL 9005</i>	260-009-032-180	1A260MR0093218DZA
		Mattnickel - <i>Satin nickel</i>	-	1A260MR0093231DZA
 	WC-Garnitur mit ovale Rosetten 32x62x10 mm mit Riegel 512 und Schlitzschraube 8mm VK <i>Lever handle on oval rose 32x62x10 mm with 512 turn and release with 8 mm spindle</i>	Schwarz RAL 9005 - <i>Matt black RAL 9005</i>	260-009-900-180	1A260RG0094218DZA
		Mattnickel - <i>Satin nickel</i>	-	1A260RG0094231DZA

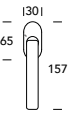
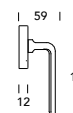
260DK015	Bezeichnung - Description	Farbe - Finishes	Alte art. nr - Old code	1 Stück - Piece
  	Fensterolive ovale Ros. 30x65 ohne Rastergehäuse (separat zu notieren*) <i>Dreh Kipp on rose without mechanism (to be ordered separately*)</i>	Schwarz RAL 9005 - <i>Matt black RAL 9005</i>	260-411-110-180	1A260DK0150018XZA
		Mattnickel - <i>Satin nickel</i>	-	1A260DK0150031XZA
	Fensterolive ovale Ros. 30x65 inklusive Rastergehäuse mit 30 mm vorstehendem Stift <i>Dreh Kipp on rose and 7x30 mm spindle (mechanism included)</i>	Schwarz RAL 9005 - <i>Matt black RAL 9005</i>	260-411-000-180	1A260DK0153018XZA
		Mattnickel - <i>Satin nickel</i>	-	1A260DK0153031XZA
	Fensterolive ovale Ros. 30x65 inklusive Reastergehäuse mit 35 mm vorstehendem Stift <i>Dreh Kipp on rose and 7x35 mm spindle (mechanism included)</i>	Schwarz RAL 9005 - <i>Matt black RAL 9005</i>	260-411-200-180	1A260DK0153518XZA
		Mattnickel - <i>Satin nickel</i>	-	1A260DK0153531XZA

*Rastergehäuse finden Sie auf Seite 419 / For mechanism please see page 419

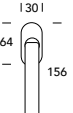
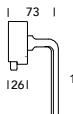
260DK075	Bezeichnung - Description	Farbe - Finishes	Alte art. nr - Old code	1 Stück - Piece
  	Fensterolive mit Druckknopf Ros. 30x64 inklusive Rastergehäuse mit 30 mm vorstehendem Stift <i>Dreh Kipp with push button on rose (mechanism included) and 7x30 mm spindle (mechanism included)</i>	Schwarz RAL 9005 - <i>Matt black RAL 9005</i>	260-075-030-180	1A260DK0753018XZA
		Mattnickel - <i>Satin nickel</i>	-	1A260DK0753031XZA
	Fensterolive mit Druckknopf Ros. 30x64 inklusive Reastergehäuse mit 35 mm vorstehendem Stift <i>Dreh Kipp with push button on rose (mechanism included) and 7x35 mm spindle (mechanism included)</i>	Schwarz RAL 9005 - <i>Matt black RAL 9005</i>	260-075-035-180	1A260DK0753518XZA
		Mattnickel - <i>Satin nickel</i>	-	1A260DK0753531XZA
	Fensterolive mit Druckknopf Ros. 30x64 mit 50 mm vorstehendem Stift <i>Dreh Kipp with push button on rose (mechanism included) and 7x50 mm spindle</i>	Schwarz RAL 9005 - <i>Matt black RAL 9005</i>	260-075-050-180	1A260DK0755018XZA
		Mattnickel - <i>Satin nickel</i>	-	1A260DK0755031XZA

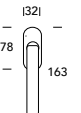
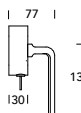
260DKC80	Bezeichnung - Description	Farbe - Finishes	Alte art. nr - Old code	1 Stück - Piece
  	Fensterolive "RC 2" zertifiziert Ros. 32x78 ohne Rastergehäuse (separat zu notieren*) <i>DK with key RC2 certified on rose 32x78 without mechanism (to be ordered separately*)</i>	Schwarz RAL 9005 - <i>Matt black RAL 9005</i>	260-C80-10E-180	1A260DKC800018XZA
		Mattnickel - <i>Satin nickel</i>	-	1A260DKC800031XZA
	Fensterolive "RC 2" zertifiziert Ros. 32x78 inklusive Rastergehäuse mit 30 mm vorstehendem Stift <i>DK with key RC2 certified on rose 32x78 and 7x30 mm spindle (mechanism included)</i>	Schwarz RAL 9005 - <i>Matt black RAL 9005</i>	260-C80-00E-180	1A260DKC803018XZA
		Mattnickel - <i>Satin nickel</i>	-	1A260DKC803031XZA
	Fensterolive "RC 2" zertifiziert Ros. 32x78 inklusive Rastergehäuse mit 35 mm vorstehendem Stift <i>DK with key RC2 certified on rose 32x78 and 7x35 mm spindle (mechanism included)</i>	Schwarz RAL 9005 - <i>Matt black RAL 9005</i>	260-C80-20E-180	1A260DKC803518XZA
		Mattnickel - <i>Satin nickel</i>	-	1A260DKC803531XZA

*Rastergehäuse finden Sie auf Seite 419 / For mechanism please see page 419

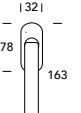
260DKT80	Bezeichnung - Description	Farbe - Finishes	Alte art. nr - Old code	1 Stück - Piece
  	Fensterolive mit TBT Funktion Ros. 32x78 ohne Rastergehäuse (separat zu notieren*) <i>Dreh Kipp with key on rose 32x78 with TBT function without mechanism (to be ordered separately*)</i>	Schwarz RAL 9005 - <i>Matt black RAL 9005</i>	260-T80-10E-180	1A260DKT800018XZA
		Mattnickel - <i>Satin nickel</i>	-	1A260DKT800031XZA
	Fensterolive mit TBT Funktion Ros. 32x78 inklusive Rastergehäuse mit 30 mm vorstehendem Stift <i>Dreh Kipp with key on rose 32x78 with TBT function and 7x30 mm spindle (mechanism included)</i>	Schwarz RAL 9005 - <i>Matt black RAL 9005</i>	260-T80-00E-180	1A260DKT803018XZA
		Mattnickel - <i>Satin nickel</i>	-	1A260DKT803031XZA
	Fensterolive mit TBT Funktion Ros. 32x78 inklusive Rastergehäuse mit 35 mm vorstehendem Stift <i>Dreh Kipp with key on rose 32x78 with TBT function and 7x35 mm spindle (mechanism included)</i>	Schwarz RAL 9005 - <i>Matt black RAL 9005</i>	260-T80-20E-180	1A260DKT803518XZA
		Mattnickel - <i>Satin nickel</i>	-	1A260DKT803531XZA

*Rastergehäuse finden Sie auf Seite 419 / For mechanism please see page 419

Essence Minimal 260

MESSING - BRASS

Datenblatt
Datasheet

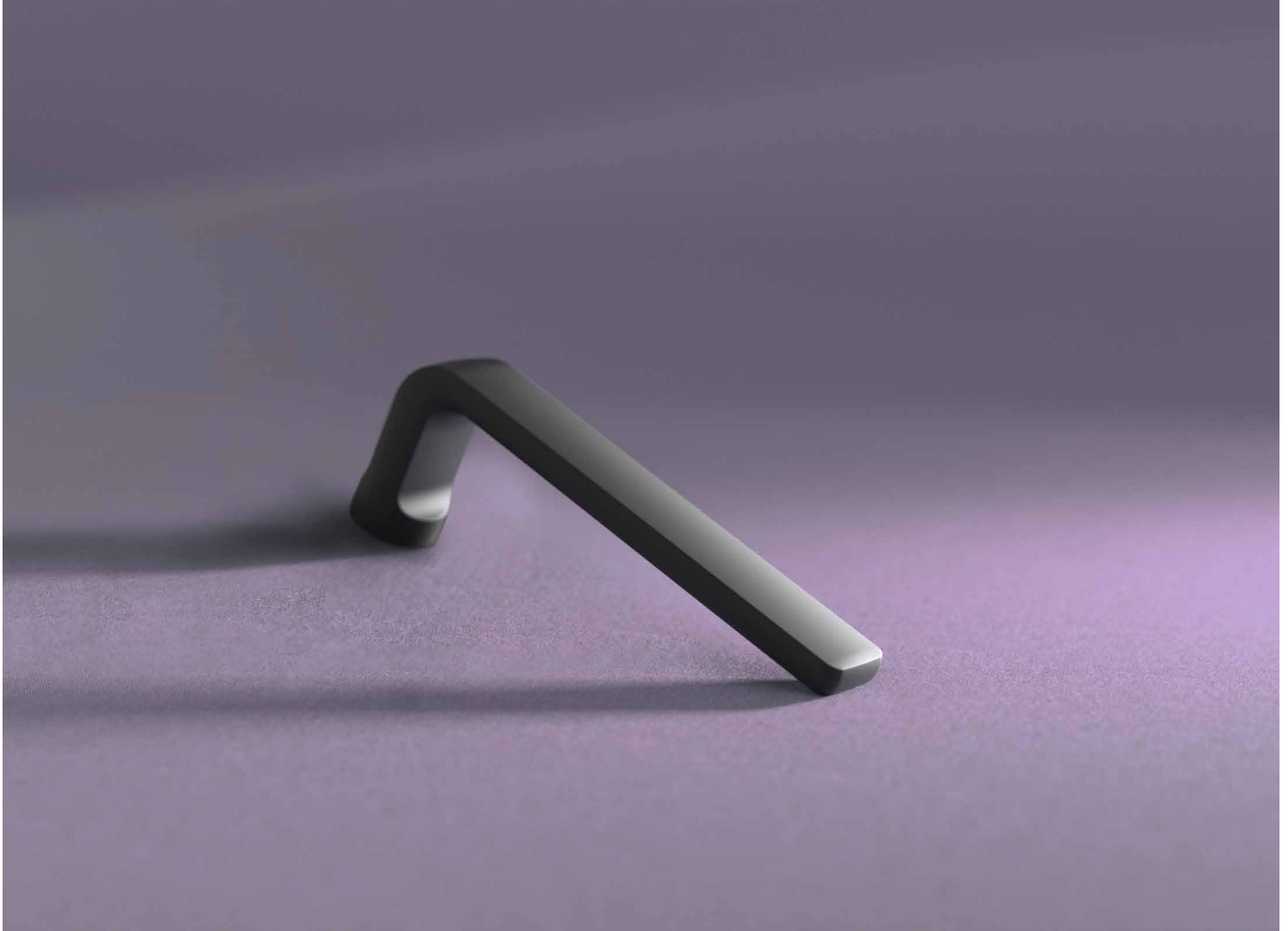

18
Schwarz RAL 9005
Matt black RAL 9005



31
Mattnickel
Satin nickel

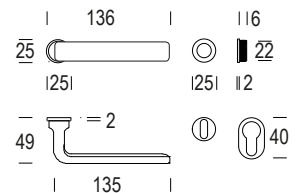

TÜRDRÜCKERGARNITUREN





260MR022

WC GARNITUREN



260RW022

260MR022	Bezeichnung - Description	Farbe - Finishes	Alte art. nr - Old code	1 Stück - Piece
	Doppelte Bezeichnung Schlüssellochung <i>Pair lever handle on rose key hole</i>	Schwarz RAL 9005 - <i>Matt black RAL 9005</i>	260-383-031-180	1A260MR0223118CZA
		Mattnickel - <i>Satin nickel</i>	-	1A260MR0223131CZA
	Doppelte Bezeichnung PZ <i>Pair lever handle on rose euro profile cylinder hole</i>	Schwarz RAL 9005 - <i>Matt black RAL 9005</i>	260-383-032-180	1A260MR0223218CZA
		Mattnickel - <i>Satin nickel</i>	-	1A260MR0223231CZA
	WC-Garnitur mit Minimal Rosetten Ø25x2 mm mit Riegel 503 und Schlitzschraube 8mm VK <i>Lever handle on minimal rose Ø25x2 mm with 503 turn and release with 8 mm spindle</i>	Schwarz RAL 9005 - <i>Matt black RAL 9005</i>	260-383-900-180	1A260RW0224218BZA
		Mattnickel - <i>Satin nickel</i>	-	1A260RW0224231BZA



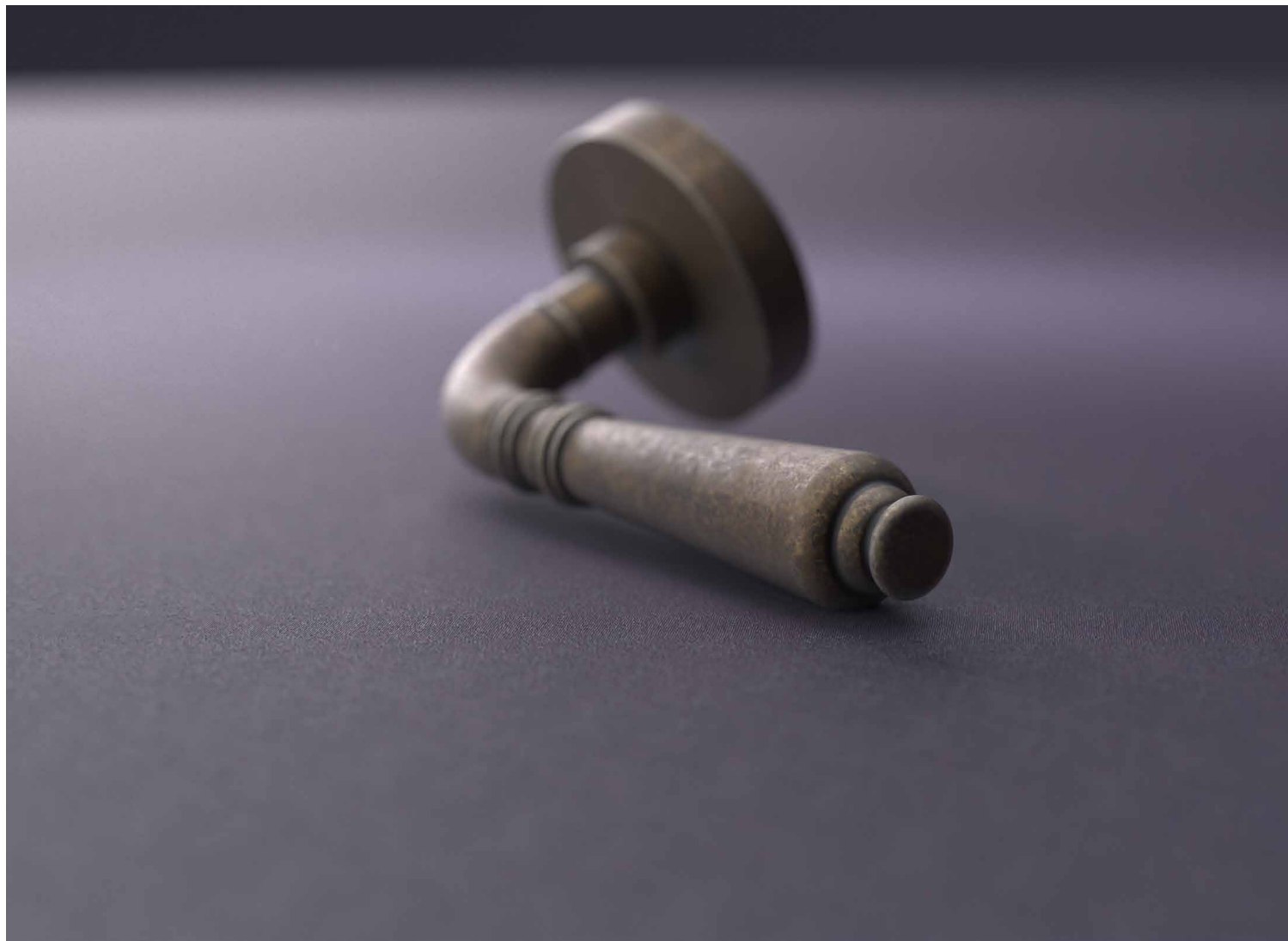

1M
Messing Rustik
Rustic brass



47
Messing Alterau
Old silver



BQ
Messing Antik Braun
Antique brass

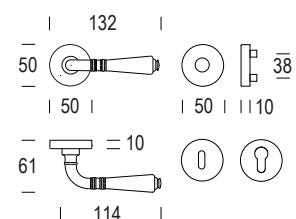

TÜRDRÜCKERGARNITUREN



040MRD17



040MR009



040MP040

WECHSELGARNITUREN



040PMD05



040PM011

WC GARNITUREN



040RGD17



040RG009



040PG040

FENSTERGRIFFE



040DK015



040DK075



040DKC80



040DKT80

















040TK015





HEBE SCHIEBTÜRGRIF SET



307MD001

Seite 426 / page 426

040MRD17	Bezeichnung - Description	Farbe - Finishes	Alte art. nr - Old code	1 Stück - Piece
 	Doppelte Bezeichnung Ø50x10 mm Schlüssellochung <i>Pair lever handle on rose Ø50x10 mm key hole</i>	Messing Rustik - Rustic brass	040-D17-031-01M	1A040MRD17311MZZA
		Messing Altgrau - Old silver	040-D17-031-047	1A040MRD173147ZZA
		Messing Antik Braun - Antique	040-D17-031-0BQ	1A040MRD1731BQZZA
 	Doppelte Bezeichnung Ø50x10 mm PZ <i>Pair lever handle on rose Ø50x10 mm euro profile cylinder hole</i>	Messing Rustik - Rustic brass	040-D17-032-01M	1A040MRD17321MZZA
		Messing Altgrau - Old silver	040-D17-032-047	1A040MRD173247ZZA
		Messing Antik Braun - Antique	040-D17-032-0BQ	1A040MRD1732BQZZA
040PMD05	Bezeichnung - Description	Farbe - Finishes	Alte art. nr - Old code	1 Stück - Piece
 	WE-Garnitur mit Knopf E56 PZ beidseitig verwendbar <i>Entrance set lever handle / knob E56 Euro profile cylinder hole (LH/RH)</i>	Messing Rustik - Rustic brass	040-D17-Y56-01M	1A040PMD05321MYZA
		Messing Altgrau - Old silver	040-D17-Y56-047	1A040PMD053247YZA
		Messing Antik Braun - Antique	040-D17-Y56-0BQ	1A040PMD0532BQYZA
040RGD17	Bezeichnung - Description	Farbe - Finishes	Alte art. nr - Old code	1 Stück - Piece
 	WC-Garnitur mit Rosetten Ø50x10 mm mit Riegel 512 und Schlitzschraube 8mm VK <i>Lever handle on rose Ø50x10 mm with 512 turn and release with 8 mm spindle</i>	Messing Rustik - Rustic brass	040-D17-900-01M	1A040RGD17421MZZA
		Messing Altgrau - Old silver	040-D17-900-047	1A040RGD174247ZZA
		Messing Antik Braun - Antique	040-D17-900-0BQ	1A040RGD1742BQZZA
040MR009	Bezeichnung - Description	Farbe - Finishes	Alte art. nr - Old code	1 Stück - Piece
 	Doppelte Bezeichnung 32x62x10 mm Schlüssellochung <i>Pair lever handle on rose 32x62x10 mm key hole</i>	Messing Rustik - Rustic brass	040-009-031-01M	1A040MR009311MDZA
		Messing Altgrau - Old silver	040-009-031-047	1A040MR0093147DZA
		Messing Antik Braun - Antique	040-009-031-0BQ	1A040MR00931BQDZA
 	Doppelte Bezeichnung 32x62x10 mm PZ <i>Pair lever handle on rose 32x62x10 mm euro profile cylinder hole</i>	Messing Rustik - Rustic brass	040-009-032-01M	1A040MR009321MDZA
		Messing Altgrau - Old silver	400-090-320-47	1A040MR0093247DZA
		Messing Antik Braun - Antique	040-009-032-0BQ	1A040MR00932BQDZA
040RG009	Bezeichnung - Description	Farbe - Finishes	Alte art. nr - Old code	1 Stück - Piece
 	WC-Garnitur mit ovale Rosetten 32x62x10 mm mit Riegel 512 und Schlitzschraube 8mm VK <i>Lever handle on oval rose 32x62x10 mm with 512 turn and release with 8 mm spindle</i>	Messing Rustik - Rustic brass	040-009-900-01M	1A040RG009421MDZA
		Messing Altgrau - Old silver	040-009-900-047	1A040RG0094247DZA
		Messing Antik Braun - Antique	040-009-900-0BQ	1A040RG00942BQDZA

040MP040	Bezeichnung - Description	Farbe - Finishes	Alte art. nr - Old code	1 Stück - Piece
	ZT-Garnitur mit Schild mit IB 72 mm Pair lever handle on plate with standard key hole 72mm	Messing Rustik - Rustic brass	040-040-006-01M	1A040MP040061MDZA
		Messing Altgrau - Old silver	040-040-006-047	1A040MP0400647DZA
		Messing Antik Braun - Antique	040-040-006-0BQ	1A040MP04006BQDZA
	ZT-Garnitur mit Schild mit PZ 72 mm Pair lever handle on plate with Euro Profile cylinder hole 72mm	Messing Rustik - Rustic brass	040-040-013-01M	1A040MP040131MDZA
		Messing Altgrau - Old silver	040-040-013-047	1A040MP0401347DZA
		Messing Antik Braun - Antique	040-040-013-0BQ	1A040MP04013BQDZA
	WE-Garnitur mit Knopf E56 72 mm PZ rechtszeigend Entrance set lever handle / knob E56 with Euro Profile cylinder hole 72mm (right hand)	Messing Rustik - Rustic brass	040-040-D13-01M	1A040PM011131MJZA
		Messing Altgrau - Old silver	040-040-D13-047	1A040PM0111347JZA
		Messing Antik Braun - Antique	040-040-D13-0BQ	1A040PM01113BQJZA
	WE-Garnitur mit Knopf E56 72 mm PZ linkszeigend Entrance set lever handle / knob E56 with Euro Profile cylinder hole 72mm (left hand)	Messing Rustik - Rustic brass	040-040-S13-01M	1A040PM011131MLZA
		Messing Altgrau - Old silver	040-040-S13-047	1A040PM0111347LZA
		Messing Antik Braun - Antique	040-040-S13-0BQ	1A040PM01113BQLZA
	WC-Garnitur mit Schild 40x246 mm, Riegel 512 & Schlitzschraube 8mm VK Pair lever handle on plate with 512 turn and release (8mm WC spindle)	Messing Rustik - Rustic brass	040-040-600-01M	1A040PG040241MVZA
		Messing Altgrau - Old silver	040-040-600-047	1A040PG0402447VZA
		Messing Antik Braun - Antique	040-040-600-0BQ	1A040PG04024BQVZA

FENSTERGRIFFE - WINDOW HANDLES

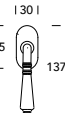
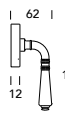

040DK015	Bezeichnung - Description	Farbe - Finishes	Alte art. nr - Old code	1 Stück - Piece
	Fensterlive ovale Ros. 30x65 ohne Rastergehäuse (separat zu notieren*) Dreh Kipp on rose without mechanism (to be ordered separately*)	Messing Rustik - Rustic brass	040-411-110-01M	1A040DK015001MXZA
		Messing Altgrau - Old silver	040-411-110-047	1A040DK0150047XZA
		Messing Antik Braun - Antique	040-411-110-0BQ	1A040DK01500BQXZA
	Fensterlive ovale Ros. 30x65 inklusive Rastergehäuse mit 30 mm vorstehendem Stift Dreh Kipp on rose and 7x30 mm spindle (mechanism included)	Messing Rustik - Rustic brass	040-411-000-01M	1A040DK015301MXZA
		Messing Altgrau - Old silver	040-411-000-047	1A040DK0153047XZA
		Messing Antik Braun - Antique	040-411-000-0BQ	1A040DK01530BQXZA
	Fensterlive ovale Ros. 30x65 inklusive Reastergehäuse mit 35 mm vorstehendem Stift Dreh Kipp on rose and 7x35 mm spindle (mechanism included)	Messing Rustik - Rustic brass	040-411-200-01M	1A040DK015351MXZA
		Messing Altgrau - Old silver	040-411-200-047	1A040DK0153547XZA
		Messing Antik Braun - Antique	040-411-200-0BQ	1A040DK01535BQXZA

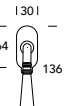
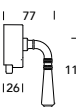
*Rastergehäuse finden Sie auf Seite 419 / For mechanism please see page 419

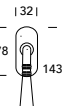
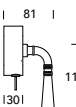
040DK075	Bezeichnung - Description	Farbe - Finishes	Alte art. nr - Old code	1 Stück - Piece
  	Fensterolive mit Druckknopf Ros. 30x64 inklusive Rastergehäuse mit 30 mm vorstehendem Stift Dreh Kipp with push button on rose (mechanism included) and 7x30 mm spindle (mechanism included)	Messing Rustik - Rustic brass	040-075-030-01M	1A040DK075301MXZA
		Messing Altgrau - Old silver	040-075-030-047	1A040DK0753047XZA
		Messing Antik Braun - Antique	040-075-030-0BQ	1A040DK07530BQXZA
	Fensterolive mit Druckknopf Ros. 30x64 inklusive Reastergehäuse mit 35 mm vorstehendem Stift Dreh Kipp with push button on rose (mechanism included) and 7x35 mm spindle (mechanism included)	Messing Rustik - Rustic brass	040-075-035-01M	1A040DK075351MXZA
		Messing Altgrau - Old silver	040-075-035-047	1A040DK0753547XZA
		Messing Antik Braun - Antique	040-075-035-0BQ	1A040DK07535BQXZA
	Fensterolive mit Druckknopf Ros. 30x64 mit 50 mm vorstehendem Stift Dreh Kipp with push button on rose (mechanism included) and 7x50 mm spindle	Messing Rustik - Rustic brass	040-075-050-01M	1A040DK075501MXZA
		Messing Altgrau - Old silver	040-075-050-047	1A040DK0755047XZA
		Messing Antik Braun - Antique	040-075-050-0BQ	1A040DK07550BQXZA

040DKC80	Bezeichnung - Description	Farbe - Finishes	Alte art. nr - Old code	1 Stück - Piece
  	Fensterolive "RC 2" zertifiziert Ros. 32x78 ohne Rastergehäuse (separat zu notieren*) DK with key RC2 certified on rose 32x78 without mechanism (to be ordered separately*)	Messing Rustik - Rustic brass	040-C80-10E-01M	1A040DKC80001MXZA
		Messing Altgrau - Old silver	040-C80-10E-047	1A040DKC800047XZA
		Messing Antik Braun - Antique	040-C80-10E-0BQ	1A040DKC8000BQXZA
	Fensterolive "RC 2" zertifiziert Ros. 32x78 inklusive Rastergehäuse mit 30 mm vorstehendem Stift DK with key RC2 certified on rose 32x78 and 7x30 mm spindle (mechanism included)	Messing Rustik - Rustic brass	040-C80-00E-01M	1A040DKC80301MXZA
		Messing Altgrau - Old silver	040-C80-00E-047	1A040DKC803047XZA
		Messing Antik Braun - Antique	040-C80-00E-0BQ	1A040DKC8030BQXZA
	Fensterolive "RC 2" zertifiziert Ros. 32x78 inklusive Reastergehäuse mit 35 mm vorstehendem Stift DK with key RC2 certified on rose 32x78 and 7x35 mm spindle (mechanism included)	Messing Rustik - Rustic brass	040-C80-20E-01M	1A040DKC80351MXZA
		Messing Altgrau - Old silver	040-C80-20E-047	1A040DKC803547XZA
		Messing Antik Braun - Antique	040-C80-20E-0BQ	1A040DKC8035BQXZA

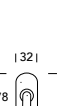
*Rastergehäuse finden Sie auf Seite 419 / For mechanism please see page 419

040DKT80	Bezeichnung - Description	Farbe - Finishes	Alte art. nr - Old code	1 Stück - Piece
  	Fensterolive mit TBT Funktion Ros. 32x78 ohne Rastergehäuse (separat zu notieren*) Dreh Kipp with key on rose 32x78 with TBT function without mechanism (to be ordered separately*)	Messing Rustik - Rustic brass	040-T80-10E-01M	1A040DKT80001MXZA
		Messing Altgrau - Old silver	040-T80-10E-047	1A040DKT800047XZA
		Messing Antik Braun - Antique	040-T80-10E-0BQ	1A040DKT8000BQXZA
	Fensterolive mit TBT Funktion Ros. 32x78 inklusive Rastergehäuse mit 30 mm vorstehendem Stift Dreh Kipp with key on rose 32x78 with TBT function and 7x30 mm spindle (mechanism included)	Messing Rustik - Rustic brass	040-T80-00E-01M	1A040DKT80301MXZA
		Messing Altgrau - Old silver	040-T80-00E-047	1A040DKT803047XZA
		Messing Antik Braun - Antique	040-T80-00E-0BQ	1A040DKT8030BQXZA
	Fensterolive mit TBT Funktion Ros. 32x78 inklusive Reastergehäuse mit 35 mm vorstehendem Stift Dreh Kipp with key on rose 32x78 with TBT function and 7x35 mm spindle (mechanism included)	Messing Rustik - Rustic brass	040-T80-20E-01M	1A040DKT80351MXZA
		Messing Altgrau - Old silver	040-T80-20E-047	1A040DKT803547XZA
		Messing Antik Braun - Antique	040-T80-20E-0BQ	1A040DKT8035BQXZA

*Rastergehäuse finden Sie auf Seite 419 / For mechanism please see page 419

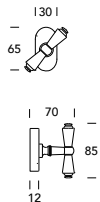
040TK015	Bezeichnung - Description	Farbe - Finishes	Alte art. nr - Old code	1 Stück - Piece
 	Fensterolive ovale Ros. 30x65 ohne Rastergehäuse (separat zu notieren*) <i>TK Dreh kipp "T" shape on rose 4 positions without mechanism (to be ordered separately*)</i>	Messing Rustik - Rustic brass	040-411-1T0-01M	1A040TK015001MXZA
		Messing Altgrau - Old silver	040-411-1T0-047	1A040TK0150047XZA
		Messing Antik Braun - Antique	040-411-1T0-0BQ	1A040TK01500BQXZA
	Fensterolive ovale Ros. 30x65 inklusive Rastergehäuse mit 30 mm vorstehendem Stift <i>TK Dreh kipp "T" shape on rose 4 positions and 7x30 mm spindle (mechanism included)</i>	Messing Rustik - Rustic brass	040-411-0T0-01M	1A040TK015301MXZA
		Messing Altgrau - Old silver	040-411-0T0-047	1A040TK0153047XZA
		Messing Antik Braun - Antique	040-411-0T0-0BQ	1A040TK01530BQXZA
	Fensterolive ovale Ros. 30x65 inklusive Rastergehäuse mit 35 mm vorstehendem Stift <i>TK Dreh kipp "T" shape on rose 4 positions and 7x35 mm spindle (mechanism included)</i>	Messing Rustik - Rustic brass	040-411-2T0-01M	1A040TK015351MXZA
		Messing Altgrau - Old silver	040-411-2T0-047	1A040TK0153547XZA
		Messing Antik Braun - Antique	040-411-2T0-0BQ	1A040TK01535BQXZA

*Rastergehäuse finden Sie auf Seite 419 / For mechanism please see page 419

Harmonie Eckig 004

MESSING - BRASS

Datenblatt
Datasheet



05
Chrom
Polished chrome



18
Schwarz RAL9005
Matt black RAL9005

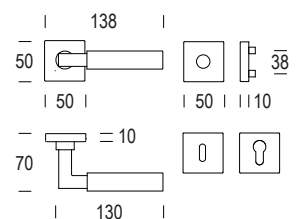

TÜRDRÜCKERGARNITUREN



004MRQD7



004MRQ01*



004MRQ09

WECHSELGARNITUREN



004PMD03

WC GARNITUREN



004RQQD7



004RQQ01



004RQQ09

FENSTERGRIFFE



004DKQ15



004DKQ75



004DKC81



004DKT81



004TKQ15

GANZGLASTÜR BESCHLÄGE















R41SR



Seite 439 / page 439



493 CE

Seite 443 / page 443



004MRQD7	Bezeichnung - Description	Farbe - Finishes	Alte art. nr - Old code	1 Stück - Piece
 	Doppelte Bezeichnung 50x50x10 mm Schlüssellochung <i>Pair lever handle on rose 50x50x10 mm key hole</i>	Chrom - Polished chrome	004-QD7-031-000	1A004MRQD73105ZZA
		Schwarz RAL 9005 - Matt black RAL 9005	004-QD7-031-180	1A004MRQD73118ZZA
 	Doppelte Bezeichnung 50x50x10 mm PZ <i>Pair lever handle on rose 50x50x10 mm euro profile cylinder hole</i>	Chrom - Polished chrome	004-QD7-032-000	1A004MRQD73205ZZA
		Schwarz RAL 9005 - Matt black RAL 9005	004-QD7-032-180	1A004MRQD73218ZZA
004PMD03	Bezeichnung - Description	Farbe - Finishes	Alte art. nr - Old code	1 Stück - Piece
 	WE-Garnitur mit Knopf J03 (373) PZ beidseitig verwendbar <i>Entrance set lever handle / knob J03 (373) Euro profile cylinder hole (LH/RH)</i>	Chrom - Polished chrome	004-QD7-Y03-000	1A004PMD033205YZA
		Schwarz RAL 9005 - Matt black RAL 9005	004-QD7-Y03-180	1A004PMD033218YZA
004RQQD7	Bezeichnung - Description	Farbe - Finishes	Alte art. nr - Old code	1 Stück - Piece
 	WC-Garnitur mit quadratische Rosette 50x50x10 mm mit Riegel 124 und Schlitzschraube 8mm VK <i>Lever handle on rose 50x50x10 mm with 124 turn and release with 8 mm spindle</i>	Chrom - Polished chrome	004-QD7-900-000	1A004RQQD74205ZZA
		Schwarz RAL 9005 - Matt black RAL 9005	004-QD7-900-180	1A004RQQD74218ZZA
004MRQ01	Bezeichnung - Description	Farbe - Finishes	Alte art. nr - Old code	1 Stück - Piece
 	Doppelte Bezeichnung Schlüssellochung <i>Pair lever handle on rose key hole</i>	Chrom - Polished chrome	004-Q01-031-000	1A004MRQ013105ZZA
		Schwarz RAL 9005 - Matt black RAL 9005	004-Q01-031-180	1A004MRQ013118ZZA
 	Doppelte Bezeichnung PZ <i>Pair lever handle on rose euro profile cylinder hole</i>	Chrom - Polished chrome	004-Q01-032-000	1A004MRQ013205ZZA
		Schwarz RAL 9005 - Matt black RAL 9005	004-Q01-032-180	1A004MRQ013218ZZA
004RQQ01	Bezeichnung - Description	Farbe - Finishes	Alte art. nr - Old code	1 Stück - Piece
 	WC-Garnitur mit Rosetten Ø50x50x5 mm mit Riegel 124 und Schlitzschraube 8mm VK <i>Lever handle on slim rose 50x50x5 mm and 124 turn and release with 8 mm spindle</i>	Chrom - Polished chrome	004-Q01-900-000	1A004RQQ014205ZZA
		Schwarz RAL 9005 - Matt black RAL 9005	004-Q01-900-180	1A004RQQ014218ZZA



004MRQ09	Bezeichnung - Description	Farbe - Finishes	Alte art. nr - Old code	1 Stück - Piece
	Doppelte Bezeichnung 32x62x10 mm Schlüssellochung Pair lever handle on rose 32x62x10 mm key hole	Chrom - Polished chrome	004-Q09-031-000	1A004MRQ093105DZA
		Schwarz RAL 9005 - Matt black RAL 9005	004-Q09-031-180	1A004MRQ093118DZA
	Doppelte Bezeichnung 32x62x10 mm PZ Pair lever handle on rose 32x62x10 mm euro profile cylinder hole	Chrom - Polished chrome	004-Q09-032-000	1A004MRQ093205DZA
		Schwarz RAL 9005 - Matt black RAL 9005	004-Q09-032-180	1A004MRQ093218DZA
004RQQ09	Bezeichnung - Description	Farbe - Finishes	Alte art. nr - Old code	1 Stück - Piece
	WC-Garnitur mit rechteckige Rosetten 32x62x10 mm mit Riegel 124 und Schlitzschraube 8mm VK Lever handle on rectangular rose 32x62x10 mm with 124 turn and release with 8 mm spindle	Chrom - Polished chrome	004-Q09-900-000	1A004RQQ094205DZA
		Schwarz RAL 9005 - Matt black RAL 9005	004-Q09-900-180	1A004RQQ094218DZA

FENSTERGRIFFE - WINDOW HANDLES

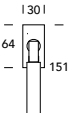
004DKQ15	Bezeichnung - Description	Farbe - Finishes	Alte art. nr - Old code	1 Stück - Piece
  	Fensterlive rechteckige Ros. 30x65 ohne Rastergehäuse (separat zu notieren*) Dreh Kipp on rose without mechanism (to be ordered separately*)	Chrom - Polished chrome	004-511-110-000	1A004DKQ150005XZA
		Schwarz RAL 9005 - Matt black RAL 9005	004-511-110-180	1A004DKQ150018XZA
		Chrom - Polished chrome	004-511-000-000	1A004DKQ153005XZA
	Fensterlive rechteckige Ros. 30x65 inklusive Rastergehäuse mit 30 mm vorstehendem Stift Dreh Kipp on rose and 7x30 mm spindle (mechanism included)	Schwarz RAL 9005 - Matt black RAL 9005	004-511-000-180	1A004DKQ153018XZA
	Fensterlive rechteckige Ros. 30x65 inklusive Reastergehäuse mit 35 mm vorstehendem Stift Dreh Kipp on rose and 7x35 mm spindle (mechanism included)	Chrom - Polished chrome	004-511-200-000	1A004DKQ153505XZA
		Schwarz RAL 9005 - Matt black RAL 9005	004-511-200-180	1A004DKQ153518XZA

*Rastergehäuse finden Sie auf Seite 419 / For mechanism please see page 419

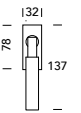

004DKQ75	Bezeichnung - Description	Farbe - Finishes	Alte art. nr - Old code	1 Stück - Piece
  	Fensterlive mit Druckknopf Ros. 30x65 inklusive Rastergehäuse mit 30 mm vorstehendem Stift <i>Dreh Kipp with push button on rose (mechanism included) and 7x30 mm spindle (mechanism included)</i>	Chrom - Polished chrome	004-Q75-030-000	1A004DKQ753005XZA
		Schwarz RAL 9005 - Matt black RAL 9005	004-Q75-030-180	1A004DKQ753018XZA
	Fensterlive mit Druckknopf Ros. 30x65 inklusive Reastergehäuse mit 35 mm vorstehendem Stift <i>Dreh Kipp with push button on rose (mechanism included) and 7x35 mm spindle (mechanism included)</i>	Chrom - Polished chrome	004-Q75-035-000	1A004DKQ753505XZA
		Schwarz RAL 9005 - Matt black RAL 9005	004-Q75-035-180	1A004DKQ753518XZA
	Fensterlive mit Druckknopf Ros. 30x65 mit 50 mm vorstehendem Stift <i>Dreh Kipp with push button on rose (mechanism included) and 7x50 mm spindle</i>	Chrom - Polished chrome	004-Q75-050-000	1A004DKQ755005XZA
		Schwarz RAL 9005 - Matt black RAL 9005	004-Q75-050-180	1A004DKQ755018XZA

004DKC81	Bezeichnung - Description	Farbe - Finishes	Alte art. nr - Old code	1 Stück - Piece
  	Fensterlive "RC 2" zertifiziert Ros. 32x78 ohne Rastergehäuse (separat zu notieren*) <i>DK with key RC2 certified on rose 32x78 without mechanism (to be ordered separately*)</i>	Chrom - Polished chrome	004-C81-10E-000	1A004DKC810005XZA
		Schwarz RAL 9005 - Matt black RAL 9005	004-C81-10E-180	1A004DKC810018XZA
	Fensterlive "RC 2" zertifiziert Ros. 32x78 inklusive Rastergehäuse mit 30 mm vorstehendem Stift <i>DK with key RC2 certified on rose 32x78 and 7x30 mm spindle (mechanism included)</i>	Chrom - Polished chrome	004-C81-00E-000	1A004DKC813005XZA
		Schwarz RAL 9005 - Matt black RAL 9005	004-C81-00E-180	1A004DKC813018XZA
	Fensterlive "RC 2" zertifiziert Ros. 32x78 inklusive Reastergehäuse mit 35 mm vorstehendem Stift <i>DK with key RC2 certified on rose 32x78 and 7x35 mm spindle (mechanism included)</i>	Chrom - Polished chrome	004-C81-20E-000	1A004DKC813505XZA
		Schwarz RAL 9005 - Matt black RAL 9005	004-C81-20E-180	1A004DKC813518XZA

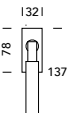
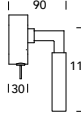
*Rastergehäuse finden Sie auf Seite 419 / For mechanism please see page 419

004DKT81	Bezeichnung - Description	Farbe - Finishes	Alte art. nr - Old code	1 Stück - Piece
  	Fensterolive mit TBT Funktion Ros. 32x78 ohne Rastergehäuse (separat zu notieren*) <i>Dreh Kipp with key on rose 32x78 with TBT function without mechanism (to be ordered separately*)</i>	Chrom - Polished chrome	004-T81-10E-000	1A004DKT810005XZA
		Schwarz RAL 9005 - Matt black RAL 9005	004-T81-10E-180	1A004DKT810018XZA
	Fensterolive mit TBT Funktion Ros. 32x78 inklusive Rastergehäuse mit 30 mm vorstehendem Stift <i>Dreh Kipp with key on rose 32x78 with TBT function and 7x30 mm spindle (mechanism included)</i>	Chrom - Polished chrome	004-T81-00E-000	1A004DKT813005XZA
		Schwarz RAL 9005 - Matt black RAL 9005	004-T81-00E-180	1A004DKT813018XZA
	Fensterolive mit TBT Funktion Ros. 32x78 inklusive Rastergehäuse mit 35 mm vorstehendem Stift <i>Dreh Kipp with key on rose 32x78 with TBT function and 7x35 mm spindle (mechanism included)</i>	Chrom - Polished chrome	004-T81-20E-000	1A004DKT813505XZA
		Schwarz RAL 9005 - Matt black RAL 9005	004-T81-20E-180	1A004DKT813518XZA

*Rastergehäuse finden Sie auf Seite 419 / For mechanism please see page 419

004TKQ15	Bezeichnung - Description	Farbe - Finishes	Alte art. nr - Old code	1 Stück - Piece
  	Fensterolive rechteckige Ros. 30x65 ohne Rastergehäuse (separat zu notieren*) <i>TK Dreh kipp "T" shape on rose 4 positions without mechanism (to be ordered separately*)</i>	Chrom - Polished chrome	004-511-1TE-000	1A004TKQ150005XZA
		Schwarz RAL 9005 - Matt black RAL 9005	004-511-1TE-180	1A004TKQ150018XZA
	Fensterolive rechteckige Ros. 30x65 inklusive Rastergehäuse mit 30 mm vorstehendem Stift <i>TK Dreh kipp "T" shape on rose 4 positions and 7x30 mm spindle (mechanism included)</i>	Chrom - Polished chrome	004-511-0TE-000	1A004TKQ153005XZA
		Schwarz RAL 9005 - Matt black RAL 9005	004-511-0TE-180	1A004TKQ153018XZA
	Fensterolive rechteckige Ros. 30x65 inklusive Rastergehäuse mit 35 mm vorstehendem Stift <i>TK Dreh kipp "T" shape on rose 4 positions and 7x35 mm spindle (mechanism included)</i>	Chrom - Polished chrome	004-511-2TE-000	1A004TKQ153505XZA
		Schwarz RAL 9005 - Matt black RAL 9005	004-511-2TE-180	1A004TKQ153518XZA

*Rastergehäuse finden Sie auf Seite 419 / For mechanism please see page 419

Harmonie Rund 004

MESSING - BRASS

Datenblatt
Datasheet



05
Chrom
Polished chrome



18
Schwarz RAL 9005
Matt black RAL 9005

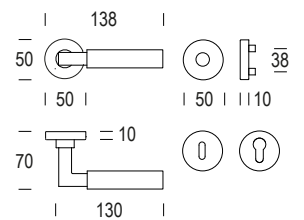

TÜRDRÜCKERGARNITUREN



004MRD17



004MRT01*



004MR009

WECHSELGARNITUREN



004PMD01

WC GARNITUREN



004RQD17



004RQT01



004RQ009

FENSTERGRIFFE



004DK015



004DK075



004DKC80

















004DKT80







SCHIEBETÜRMUSCHEL





J02PI002

Seite 434 / page 434

004MRD17	Bezeichnung - Description	Farbe - Finishes	Alte art. nr - Old code	1 Stück - Piece
	 Doppelte Bezeichnung Ø50x10 mm Schlüssellochung <i>Pair lever handle on rose Ø50x10 mm key hole</i>	Chrom - Polished chrome	004-D17-031-000	1A004MRD173105ZZA
		Schwarz RAL 9005 - Matt black RAL 9005	004-D17-031-180	1A004MRD173118ZZA
	 Doppelte Bezeichnung Ø50x10 mm PZ <i>Pair lever handle on rose Ø50x10 mm euro profile cylinder hole</i>	Chrom - Polished chrome	004-D17-032-000	1A004MRD173205ZZA
		Schwarz RAL 9005 - Matt black RAL 9005	004-D17-032-180	1A004MRD173218ZZA
004PMD01	Bezeichnung - Description	Farbe - Finishes	Alte art. nr - Old code	1 Stück - Piece
	 WE-Garnitur mit Knopf J01 (420) PZ beidseitig verwendbar <i>Entrance set lever handle / knob J01 (420) Euro profile cylinder hole (LH/RH)</i>	Chrom - Polished chrome	004-D17-Y01-000	1A004PMD013205YZA
		Schwarz RAL 9005 - Matt black RAL 9005	004-D17-Y01-180	1A004PMD013218YZA
004RQD17	Bezeichnung - Description	Farbe - Finishes	Alte art. nr - Old code	1 Stück - Piece
	 WC-Garnitur mit Rosetten Ø50x10 mm mit Riegel 124 und Schlitzschraube 8mm VK <i>Lever handle on rose Ø50x10 mm with 124 turn and release with 8 mm spindle</i>	Chrom - Polished chrome	004-D17-900-000	1A004RQD174205ZZA
		Schwarz RAL 9005 - Matt black RAL 9005	004-D17-900-180	1A004RQD174218ZZA
004MRT01	Bezeichnung - Description	Farbe - Finishes	Alte art. nr - Old code	1 Stück - Piece
	 Doppelte Bezeichnung Schlüssellochung <i>Pair lever handle on rose key hole</i>	Chrom - Polished chrome	004-T01-031-000	1A004MRT013105ZZA
		Schwarz RAL 9005 - Matt black RAL 9005	004-T01-031-180	1A004MRT013118ZZA
	 Doppelte Bezeichnung PZ <i>Pair lever handle on rose euro profile cylinder hole</i>	Chrom - Polished chrome	004-T01-032-000	1A004MRT013205ZZA
		Schwarz RAL 9005 - Matt black RAL 9005	004-T01-032-180	1A004MRT013218ZZA
004RQT01	Bezeichnung - Description	Farbe - Finishes	Alte art. nr - Old code	1 Stück - Piece
	 WC-Garnitur mit Slim Rosetten Ø50x5 mm mit Riegel 124 und Schlitzschraube 8mm VK <i>Lever handle on rose Ø50x5 mm with 124 turn and release with 8 mm spindle</i>	Chrom - Polished chrome	004-T01-900-000	1A004RQT014205ZZA
		Schwarz RAL 9005 - Matt black RAL 9005	004-T01-900-180	1A004RQT014218ZZA

004MR009	Bezeichnung - Description	Farbe - Finishes	Alte art. nr - Old code	1 Stück - Piece
	 Doppelte Bezeichnung 32x62x10 mm Schlüssellochung <i>Pair lever handle on rose 32x62x10 mm key hole</i>	Chrom - Polished chrome	004-009-031-000	1A004MR0093105DZA
		Schwarz RAL 9005 - Matt black RAL 9005	004-009-031-180	1A004MR0093118DZA
	 Doppelte Bezeichnung 32x62x10 mm PZ <i>Pair lever handle on rose 32x62x10 mm euro profile cylinder hole</i>	Chrom - Polished chrome	004-009-032-000	1A004MR0093205DZA
		Schwarz RAL 9005 - Matt black RAL 9005	004-009-032-180	1A004MR0093218DZA
004RQ009	Bezeichnung - Description	Farbe - Finishes	Alte art. nr - Old code	1 Stück - Piece
	 WC-Garnitur mit ovale Rosetten 32x62x10 mm mit Riegel 124 und Schlitzschraube 8mm VK <i>Lever handle on oval rose 32x62x10 mm with 124 turn and release with 8 mm spindle</i>	Chrom - Polished chrome	-	1A004RQ0094205DZA
		Schwarz RAL 9005 - Matt black RAL 9005	-	1A004RQ0094218DZA

FENSTERGRIFFE - WINDOW HANDLES

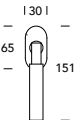
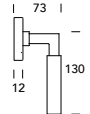
004DK015	Bezeichnung - Description	Farbe - Finishes	Alte art. nr - Old code	1 Stück - Piece
   	Fensterolive ovale Ros. 30x65 ohne Rastergehäuse (separat zu notieren*) <i>Dreh Kipp on rose without mechanism (to be ordered separately*)</i>	Chrom - Polished chrome	004-411-110-000	1A004DK015005XZA
		Schwarz RAL 9005 - Matt black RAL 9005	004-411-110-180	1A004DK0150018XZA
	Fensterolive ovale Ros. 30x65 inklusive Rastergehäuse mit 30 mm vorstehendem Stift <i>Dreh Kipp on rose and 7x30 mm spindle (mechanism included)</i>	Chrom - Polished chrome	004-411-000-000	1A004DK0153005XZA
		Schwarz RAL 9005 - Matt black RAL 9005	004-411-000-180	1A004DK0153018XZA
	Fensterolive ovale Ros. 30x65 inklusive Reastergehäuse mit 35 mm vorstehendem Stift <i>Dreh Kipp on rose and 7x35 mm spindle (mechanism included)</i>	Chrom - Polished chrome	004-411-200-000	1A004DK0153505XZA
		Schwarz RAL 9005 - Matt black RAL 9005	004-411-200-180	1A004DK0153518XZA

*Rastergehäuse finden Sie auf Seite 419 / For mechanism please see page 419

004DK075	Bezeichnung - Description	Farbe - Finishes	Alte art. nr - Old code	1 Stück - Piece
	Fensterlive mit Druckknopf Ros. 30x64 inklusive Rastergehäuse mit 30 mm vorstehendem Stift <i>Dreh Kipp with push button on rose (mechanism included) and 7x30 mm spindle (mechanism included)</i>	Chrom - Polished chrome	004-075-030-000	1A004DK0753005XZA
		Schwarz RAL 9005 - Matt black RAL 9005	004-075-030-180	1A004DK0753018XZA
	Fensterlive mit Druckknopf Ros. 30x64 inklusive Reastergehäuse mit 35 mm vorstehendem Stift <i>Dreh Kipp with push button on rose (mechanism included) and 7x35 mm spindle (mechanism included)</i>	Chrom - Polished chrome	004-075-035-000	1A004DK0753505XZA
		Schwarz RAL 9005 - Matt black RAL 9005	004-075-035-180	1A004DK0753518XZA
	Fensterlive mit Druckknopf Ros. 30x64 mit 50 mm vorstehendem Stift <i>Dreh Kipp with push button on rose (mechanism included) and 7x50 mm spindle</i>	Chrom - Polished chrome	004-075-050-000	1A004DK0755005XZA
		Schwarz RAL 9005 - Matt black RAL 9005	004-075-050-180	1A004DK0755018XZA

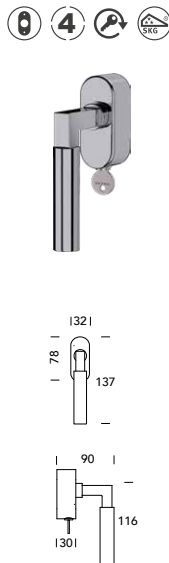
004DKC80	Bezeichnung - Description	Farbe - Finishes	Alte art. nr - Old code	1 Stück - Piece
	Fensterlive "RC 2" zertifiziert Ros. 32x78 ohne Rastergehäuse (separat zu notieren*) <i>DK with key RC2 certified on rose 32x78 without mechanism (to be ordered separately*)</i>	Chrom - Polished chrome	004-C80-10E-000	1A004DKC800005XZA
		Schwarz RAL 9005 - Matt black RAL 9005	004-C80-10E-180	1A004DKC800018XZA
	Fensterlive "RC 2" zertifiziert Ros. 32x78 inklusive Rastergehäuse mit 30 mm vorstehendem Stift <i>DK with key RC2 certified on rose 32x78 and 7x30 mm spindle (mechanism included)</i>	Chrom - Polished chrome	004-C80-00E-000	1A004DKC803005XZA
		Schwarz RAL 9005 - Matt black RAL 9005	004-C80-00E-180	1A004DKC803018XZA
	Fensterlive "RC 2" zertifiziert Ros. 32x78 inklusive Reastergehäuse mit 35 mm vorstehendem Stift <i>DK with key RC2 certified on rose 32x78 and 7x35 mm spindle (mechanism included)</i>	Chrom - Polished chrome	004-C80-20E-000	1A004DKC803505XZA
		Schwarz RAL 9005 - Matt black RAL 9005	004-C80-20E-180	1A004DKC803518XZA

*Rastergehäuse finden Sie auf Seite 419 / For mechanism please see page 419

004DKT80	Bezeichnung - Description	Farbe - Finishes	Alte art. nr - Old code	1 Stück - Piece
	Fensterlive mit TBT Funktion Ros. 32x78 ohne Rastergehäuse (separat zu notieren*) <i>Dreh Kipp with key on rose 32x78 with TBT function without mechanism (to be ordered separately*)</i>	Chrom - Polished chrome	004-T80-10E-000	1A004DKT800005XZA
		Schwarz RAL 9005 - Matt black RAL 9005	004-T80-10E-180	1A004DKT800018XZA
	Fensterlive mit TBT Funktion Ros. 32x78 inklusive Rastergehäuse mit 30 mm vorstehendem Stift <i>Dreh Kipp with key on rose 32x78 with TBT function and 7x30 mm spindle (mechanism included)</i>	Chrom - Polished chrome	004-T80-00E-000	1A004DKT803005XZA
		Schwarz RAL 9005 - Matt black RAL 9005	004-T80-00E-180	1A004DKT803018XZA
	Fensterlive mit TBT Funktion Ros. 32x78 inklusive Reastergehäuse mit 35 mm vorstehendem Stift <i>Dreh Kipp with key on rose 32x78 with TBT function and 7x35 mm spindle (mechanism included)</i>	Chrom - Polished chrome	004-T80-20E-000	1A004DKT803505XZA
		Schwarz RAL 9005 - Matt black RAL 9005	004-T80-20E-180	1A004DKT803518XZA

*Rastergehäuse finden Sie auf Seite 419 / For mechanism please see page 419

Ixia Eckig J40

TEKNOMETAL

Datenblatt
Datasheet

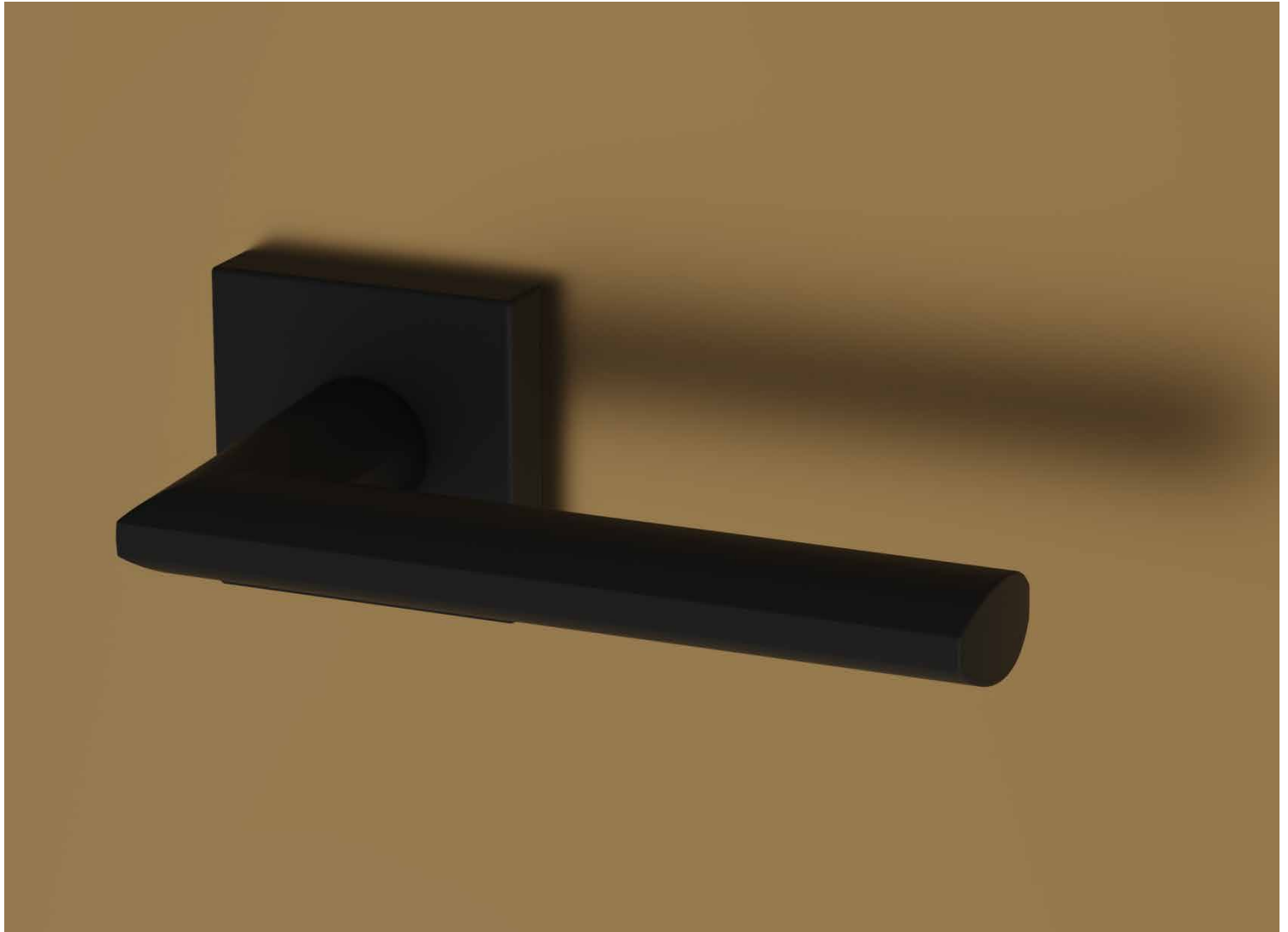

18
Schwarz RAL 9005
Matt black RAL 9005

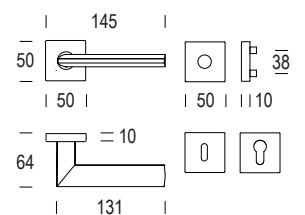

TÜRDRÜCKERGARNITUREN



J40MRQD7

WECHSELGARNITUREN



J40PMD03

WC GARNITUREN



J40RQQD7

FENSTERGRIFFE



J40DKQ15







J40DKQ75



J40DKC81



J40DKT81

J40MRQD7	Bezeichnung - Description	Farbe - Finishes	Alte art. nr - Old code	1 Stück - Piece
	Doppelte Bezeichnung 50x50x10 mm Schlüssellochung <i>Pair lever handle on rose 50x50x10 mm key hole</i>	Schwarz RAL 9005 - Matt black RAL 9005	J40-QD7-031-180	1AJ40MRQD73118ZZA
	Doppelte Bezeichnung 50x50x10 mm PZ <i>Pair lever handle on rose 50x50x10 mm euro profile cylinder hole</i>	Schwarz RAL 9005 - Matt black RAL 9005	J40-QD7-032-180	1AJ40MRQD73218ZZA
	WE-Garnitur mit Knopf J03 (373) PZ beidseitig verwendbar <i>Entrance set lever handle / knob J03 (373) Euro profile cylinder hole (LH/RH)</i>	Schwarz RAL 9005 - Matt black RAL 9005	J40-QD7-Y03-180	1AJ40PMD033218YZA
	WC-Garnitur mit quadratische Rosette 50x50x10 mm mit Riegel 124 und Schlitzschraube 8mm VK <i>Lever handle on rose 50x50x10 mm with 124 turn and release with 8 mm spindle</i>	Schwarz RAL 9005 - Matt black RAL 9005	J40-QD7-900-180	1AJ40RQQD74218ZZA

FENSTERGRIFFE - WINDOW HANDLES

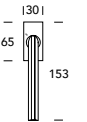
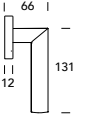
J40DKQ15	Bezeichnung - Description	Farbe - Finishes	Alte art. nr - Old code	1 Stück - Piece
	Fensterolive rechteckige Ros. 30x65 ohne Rastergehäuse (separat zu notieren*) <i>Dreh Kipp on rose without mechanism (to be ordered separately*)</i>	Schwarz RAL 9005 - Matt black RAL 9005	J40-511-110-180	1AJ40DKQ150018XZA
	Fensterolive rechteckige Ros. 30x65 inklusive Rastergehäuse mit 30 mm vorstehendem Stift <i>Dreh Kipp on rose and 7x30 mm spindle (mechanism included)</i>	Schwarz RAL 9005 - Matt black RAL 9005	J40-511-000-180	1AJ40DKQ153018XZA
	Fensterolive rechteckige Ros. 30x65 inklusive Rastergehäuse mit 35 mm vorstehendem Stift <i>Dreh Kipp on rose and 7x35 mm spindle (mechanism included)</i>	Schwarz RAL 9005 - Matt black RAL 9005	J40-511-200-180	1AJ40DKQ153518XZA

*Rastergehäuse finden Sie auf Seite 419 / For mechanism please see page 419

J40DKQ75	Bezeichnung - Description	Farbe - Finishes	Alte art. nr - Old code	1 Stück - Piece
	Fensterolive mit Druckknopf Ros. 30x65 inklusive Rastergehäuse mit 30 mm vorstehendem Stift Dreh Kipp with push button on rose (mechanism included) and 7x30 mm spindle (mechanism included)	Schwarz RAL 9005 - Matt black RAL 9005	J40-Q75-030-180	1AJ40DKQ753018XZA
	Fensterolive mit Druckknopf Ros. 30x65 inklusive Reastergehäuse mit 35 mm vorstehendem Stift Dreh Kipp with push button on rose (mechanism included) and 7x35 mm spindle (mechanism included)	Schwarz RAL 9005 - Matt black RAL 9005	J40-Q75-035-180	1AJ40DKQ753518XZA
	Fensterolive mit Druckknopf Ros. 30x65 mit 50 mm vorstehendem Stift Dreh Kipp with push button on rose (mechanism included) and 7x50 mm spindle	Schwarz RAL 9005 - Matt black RAL 9005	J40-Q75-050-180	1AJ40DKQ755018XZA

J40DKC81	Bezeichnung - Description	Farbe - Finishes	Alte art. nr - Old code	1 Stück - Piece
	Fensterolive "RC 2" zertifiziert Ros. 32x78 ohne Rastergehäuse (separat zu notieren*) DK with key RC2 certified on rose 32x78 without mechanism (to be ordered separately*)	Schwarz RAL 9005 - Matt black RAL 9005	J40-C81-10E-180	1AJ40DKC810018XZA
	Fensterolive "RC 2" zertifiziert Ros. 32x78 inklusive Rastergehäuse mit 30 mm vorstehendem Stift DK with key RC2 certified on rose 32x78 and 7x30 mm spindle (mechanism included)	Schwarz RAL 9005 - Matt black RAL 9005	J40-C81-00E-180	1AJ40DKC813018XZA
	Fensterolive "RC 2" zertifiziert Ros. 32x78 inklusive Reastergehäuse mit 35 mm vorstehendem Stift DK with key RC2 certified on rose 32x78 and 7x35 mm spindle (mechanism included)	Schwarz RAL 9005 - Matt black RAL 9005	J40-C81-20E-180	1AJ40DKC813518XZA

*Rastergehäuse finden Sie auf Seite 419 / For mechanism please see page 419

J40DKT81	Bezeichnung - Description	Farbe - Finishes	Alte art. nr - Old code	1 Stück - Piece
	Fensterolive mit TBT Funktion Ros. 32x78 ohne Rastergehäuse (separat zu notieren*) Dreh Kipp with key on rose 32x78 with TBT function without mechanism (to be ordered separately*)	Schwarz RAL 9005 - Matt black RAL 9005	J40-T81-10E-180	1AJ40DKT810018XZA
	Fensterolive mit TBT Funktion Ros. 32x78 inklusive Rastergehäuse mit 30 mm vorstehendem Stift Dreh Kipp with key on rose 32x78 with TBT function and 7x30 mm spindle (mechanism included)	Schwarz RAL 9005 - Matt black RAL 9005	J40-T81-00E-180	1AJ40DKT813018XZA
	Fensterolive mit TBT Funktion Ros. 32x78 inklusive Reastergehäuse mit 35 mm vorstehendem Stift Dreh Kipp with key on rose 32x78 with TBT function and 7x35 mm spindle (mechanism included)	Schwarz RAL 9005 - Matt black RAL 9005	J40-T81-20E-180	1AJ40DKT813518XZA

*Rastergehäuse finden Sie auf Seite 419 / For mechanism please see page 419

Ixia Rund J40

TEKNOMETAL

Datenblatt
Datasheet



18
Schwarz RAL 9005
Matt black RAL 9005

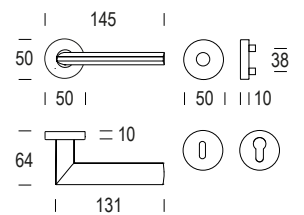

TÜRDRÜCKERGARNITUREN



J40MRD17

WECHSELGARNITUREN



J40PMD01

WC GARNITUREN



J40RGD17

FENSTERGRIFFE



J40DK015







J40DK075





J40DKC80



J40DKT80

J40MRD17	Bezeichnung - Description	Farbe - Finishes	Alte art. nr - Old code	1 Stück - Piece
	Doppelte Bezeichnung Ø50x10 mm Schlüssellochung <i>Pair lever handle on rose Ø50x10 mm key hole</i>	Schwarz RAL 9005 - Matt black RAL 9005	J40-D17-031-180	1AJ40MRD173118ZZA
	Doppelte Bezeichnung Ø50x10 mm PZ <i>Pair lever handle on rose Ø50x10 mm euro profile cylinder hole</i>	Schwarz RAL 9005 - Matt black RAL 9005	J40-D17-032-180	1AJ40MRD173218ZZA
	WE-Garnitur mit Knopf J01 (420) PZ beidseitig verwendbar <i>Entrance set lever handle / knob J01 (420) Euro profile cylinder hole (LH/RH)</i>	Schwarz RAL 9005 - Matt black RAL 9005	J40-D17-Y01-180	1AJ40PMD013218YZA
	WC-Garnitur mit Rosetten Ø50x10 mm mit Riegel 512 und Schlitzschraube 8mm VK <i>Lever handle on rose Ø50x10 mm with 512 turn and release with 8 mm spindle</i>	Schwarz RAL 9005 - Matt black RAL 9005	J40-D17-900-180	1AJ40RGD174218ZZA

FENSTERGRIFFE - WINDOW HANDLES

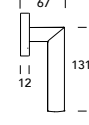
J40DK015	Bezeichnung - Description	Farbe - Finishes	Alte art. nr - Old code	1 Stück - Piece
 	Fensterolive ovale Ros. 30x65 ohne Rastergehäuse (separat zu notieren*) <i>Dreh Kipp on rose without mechanism (to be ordered separately*)</i>	Schwarz RAL 9005 - Matt black RAL 9005	J40-411-110-180	1AJ40DK0150018XZA
	Fensterolive ovale Ros. 30x65 inklusive Rastergehäuse mit 30 mm vorstehendem Stift <i>Dreh Kipp on rose and 7x30 mm spindle (mechanism included)</i>	Schwarz RAL 9005 - Matt black RAL 9005	J40-411-000-180	1AJ40DK0153018XZA
	Fensterolive ovale Ros. 30x65 inklusive Reastergehäuse mit 35 mm vorstehendem Stift <i>Dreh Kipp on rose and 7x35 mm spindle (mechanism included)</i>	Schwarz RAL 9005 - Matt black RAL 9005	J40-411-200-180	1AJ40DK0153518XZA

*Rastergehäuse finden Sie auf Seite 419 / For mechanism please see page 419

J40DK075	Bezeichnung - Description	Farbe - Finishes	Alte art. nr - Old code	1 Stück - Piece
	Fensterolive mit Druckknopf Ros. 30x64 inklusive Rastergehäuse mit 30 mm vorstehendem Stift Dreh Kipp with push button on rose (mechanism included) and 7x30 mm spindle (mechanism included)	Schwarz RAL 9005 - Matt black RAL 9005	J40-075-030-180	1AJ40DK0753018XZA
	Fensterolive mit Druckknopf Ros. 30x64 inklusive Reastergehäuse mit 35 mm vorstehendem Stift Dreh Kipp with push button on rose (mechanism included) and 7x35 mm spindle (mechanism included)	Schwarz RAL 9005 - Matt black RAL 9005	J40-075-035-180	1AJ40DK0753518XZA
	Fensterolive mit Druckknopf Ros. 30x64 mit 50 mm vorstehendem Stift Dreh Kipp with push button on rose (mechanism included) and 7x50 mm spindle	Schwarz RAL 9005 - Matt black RAL 9005	J40-075-050-180	1AJ40DK0755018XZA

J40DKC80	Bezeichnung - Description	Farbe - Finishes	Alte art. nr - Old code	1 Stück - Piece
	Fensterolive "RC 2" zertifiziert Ros. 32x78 ohne Rastergehäuse (separat zu notieren*) DK with key RC2 certified on rose 32x78 without mechanism (to be ordered separately*)	Schwarz RAL 9005 - Matt black RAL 9005	J40-C80-10E-180	1AJ40DKC800018XZA
	Fensterolive "RC 2" zertifiziert Ros. 32x78 inklusive Rastergehäuse mit 30 mm vorstehendem Stift DK with key RC2 certified on rose 32x78 and 7x30 mm spindle (mechanism included)	Schwarz RAL 9005 - Matt black RAL 9005	J40-C80-00E-180	1AJ40DKC803018XZA
	Fensterolive "RC 2" zertifiziert Ros. 32x78 inklusive Reastergehäuse mit 35 mm vorstehendem Stift DK with key RC2 certified on rose 32x78 and 7x35 mm spindle (mechanism included)	Schwarz RAL 9005 - Matt black RAL 9005	J40-C80-20E-180	1AJ40DKC803518XZA

*Rastergehäuse finden Sie auf Seite 419 / For mechanism please see page 419

J40DKT80	Bezeichnung - Description	Farbe - Finishes	Alte art. nr - Old code	1 Stück - Piece
	Fensterolive mit TBT Funktion Ros. 32x78 ohne Rastergehäuse (separat zu notieren*) Dreh Kipp with key on rose 32x78 with TBT function without mechanism (to be ordered separately*)	Schwarz RAL 9005 - Matt black RAL 9005	J40-T80-10E-180	1AJ40DKT800018XZA
	Fensterolive mit TBT Funktion Ros. 32x78 inklusive Rastergehäuse mit 30 mm vorstehendem Stift Dreh Kipp with key on rose 32x78 with TBT function and 7x30 mm spindle (mechanism included)	Schwarz RAL 9005 - Matt black RAL 9005	J40-T80-00E-180	1AJ40DKT803018XZA
	Fensterolive mit TBT Funktion Ros. 32x78 inklusive Reastergehäuse mit 35 mm vorstehendem Stift Dreh Kipp with key on rose 32x78 with TBT function and 7x35 mm spindle (mechanism included)	Schwarz RAL 9005 - Matt black RAL 9005	J40-T80-20E-180	1AJ40DKT803518XZA

*Rastergehäuse finden Sie auf Seite 419 / For mechanism please see page 419

Ixia Minimal J40

TEKNOMETAL

Datenblatt
Datasheet



18
Schwarz RAL 9005
Matt black RAL 9005

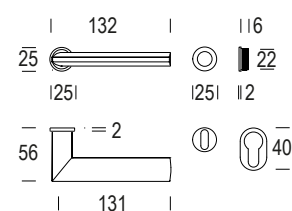

TÜRDRÜCKERGARNITUREN









0

J40MR022

WC GARNITUREN



J40RW022

J40MR022	Bezeichnung - Description	Farbe - Finishes	Alte art. nr - Old code	1 Stück - Piece
 	<p>Doppelte Bezeichnung Schlüssellochung</p> <p><i>Pair lever handle on rose key hole</i></p>	<p>Schwarz RAL 9005 - <i>Matt black RAL 9005</i></p>	<p>J40-383-031-180</p>	<p>1AJ40MR0223118CZA</p>
 	<p>Doppelte Bezeichnung PZ</p> <p><i>Pair lever handle on rose euro profile cylinder hole</i></p>	<p>Schwarz RAL 9005 - <i>Matt black RAL 9005</i></p>	<p>J40-383-032-180</p>	<p>1AJ40MR0223218CZA</p>
 	<p>WC-Garnitur mit Minimal Rosetten Ø25x2 mm mit Riegel 503 und Schlitzschraube 8mm VK</p> <p><i>Lever handle on minimal rose Ø25x2 mm with 503 turn and release with 8 mm spindle</i></p>	<p>Schwarz RAL 9005 - <i>Matt black RAL 9005</i></p>	<p>J40-383-900-180</p>	<p>1AJ40RW0224218BZA</p>



Klass 180

MESSING - BRASS

Datenblatt
Datasheet



05
Chrom
Polished chrome



18
Schwarz RAL 9005
Matt black RAL 9005



1M
Messing Rustik
Rustic brass

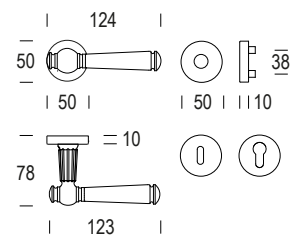
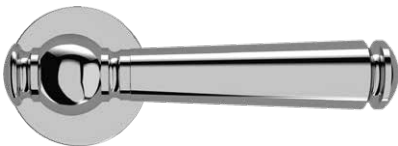

TÜRDRÜCKERGARNITUREN



180MRD17



180MP040

WECHSELGARNITUREN



180PMD01



180PM011

WC GARNITUREN



180RGD17



180PG040

FENSTERGRIFFE



180DK015



180DK075



180DKC80











180DKT80

SCHIEBETÜRMUSCHEL



J03PI001

Seite 434 / page 434

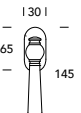
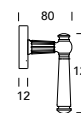

180MRD17	Bezeichnung - Description	Farbe - Finishes	Alte art. nr - Old code	1 Stück - Piece
 	Doppelte Bezeichnung Ø50x10 mm Schlüsselloch Pair lever handle on rose Ø50x10 mm key hole	Chrom - Polished chrome	180-D17-031-000	1A180MRD173105ZZA
		Schwarz RAL 9005 - Matt black RAL 9005	180-D17-031-180	1A180MRD173118ZZA
		Messing Rustik - Rustic brass	180-D17-031-01M	1A180MRD17311MZZA
 	Doppelte Bezeichnung Ø50x10 mm PZ Pair lever handle on rose Ø50x10 mm euro profile cylinder hole	Chrom - Polished chrome	180-D17-032-000	1A180MRD173205ZZA
		Schwarz RAL 9005 - Matt black RAL 9005	180-D17-032-180	1A180MRD173218ZZA
		Messing Rustik - Rustic brass	180-D17-032-01M	1A180MRD17321MZZA
 	WE-Garnitur mit Knopf J01 (420) PZ beidseitig verwendbar Entrance set lever handle / knob J01 (420) Euro profile cylinder hole (LH/RH)	Chrom - Polished chrome	180-D17-Y01-000	1A180PMD013205YZA
		Schwarz RAL 9005 - Matt black RAL 9005	180-D17-Y01-180	1A180PMD013218YZA
		Messing Rustik - Rustic brass	180-D17-Y01-01M	1A180PMD01321MYZA
 	WC-Garnitur mit Rosetten Ø50x10 mm mit Riegel 512 und Schlitzschraube 8mm VK Lever handle on rose Ø50x10 mm with 512 turn and release with 8 mm spindle	Chrom - Polished chrome	180-D17-900-000	1A180RGD174205ZZA
		Schwarz RAL 9005 - Matt black RAL 9005	180-D17-900-180	1A180RGD174218ZZA
		Messing Rustik - Rustic brass	180-D17-900-01M	1A180RGD17421MZZA

180MP040	Bezeichnung - Description	Farbe - Finishes	Alte art. nr - Old code	1 Stück - Piece
	ZT-Garnitur mit Schild mit IB 72 mm <i>Pair lever handle on plate with standard key hole 72mm</i>	Chrom - Polished chrome	180-040-006-000	1A180MP0400605XZA
		Schwarz RAL 9005 - Matt black RAL 9005	180-040-006-180	1A180MP0400618XZA
		Messing Rustik - Rustic brass	180-040-006-01M	1A180MP040061MXZA
	ZT-Garnitur mit Schild mit PZ 72 mm <i>Pair lever handle on plate with Euro Profile cylinder hole 72mm</i>	Chrom - Polished chrome	180-040-013-000	1A180MP0401305XZA
		Schwarz RAL 9005 - Matt black RAL 9005	180-040-013-180	1A180MP0401318XZA
		Messing Rustik - Rustic brass	180-040-013-01M	1A180MP040131MXZA
	WE-Garnitur mit Knopf E56 72 mm PZ rechtszeigend <i>Entrance set lever handle / knob E56 with Euro Profile cylinder hole 72mm (right hand)</i>	Chrom - Polished chrome	180-040-D13-000	1A180PM0111305JZA
		Schwarz RAL 9005 - Matt black RAL 9005	180-040-D13-180	1A180PM0111318JZA
		Messing Rustik - Rustic brass	180-040-D13-01M	1A180PM011131MJZA
	WE-Garnitur mit Knopf E56 72 mm PZ linkszeigend <i>Entrance set lever handle / knob E56 with Euro Profile cylinder hole 72mm (left hand)</i>	Chrom - Polished chrome	180-040-S13-000	1A180PM0111305LZA
		Schwarz RAL 9005 - Matt black RAL 9005	180-040-S13-180	1A180PM0111318LZA
		Messing Rustik - Rustic brass	180-040-S13-01M	1A180PM011131MLZA
	WC-Garnitur mit Schild 40x246 mm, Riegel 512 & Schlitzschraube 8mm VK <i>Pair lever handle on plate with 512 turn and release (8mm WC spindle)</i>	Chrom - Polished chrome	180-040-600-000	1A180PG0402405VZA
		Schwarz RAL 9005 - Matt black RAL 9005	180-040-600-180	1A180PG0402418VZA
		Messing Rustik - Rustic brass	180-040-600-01M	1A180PG040241MVZA

180DK015	Bezeichnung - Description	Farbe - Finishes	Alte art. nr - Old code	1 Stück - Piece
  	Fensterolive ovale Ros. 30x65 ohne Rastergehäuse (separat zu notieren*) <i>Dreh Kipp on rose without mechanism (to be ordered separately*)</i>	Chrom - Polished chrome	180-411-110-000	1A180DK0150005XZA
		Schwarz RAL 9005 - Matt black RAL 9005	180-411-110-180	1A180DK0150018XZA
		Messing Rustik - Rustic brass	180-411-110-01M	1A180DK015001MXZA
	Fensterolive ovale Ros. 30x65 inklusive Rastergehäuse mit 30 mm vorstehendem Stift <i>Dreh Kipp on rose and 7x30 mm spindle (mechanism included)</i>	Chrom - Polished chrome	180-411-000-000	1A180DK0153005XZA
		Schwarz RAL 9005 - Matt black RAL 9005	180-411-000-180	1A180DK0153018XZA
		Messing Rustik - Rustic brass	180-411-000-01M	1A180DK015301MXZA
	Fensterolive ovale Ros. 30x65 inklusive Reastergehäuse mit 35 mm vorstehendem Stift <i>Dreh Kipp on rose and 7x35 mm spindle (mechanism included)</i>	Chrom - Polished chrome	180-411-200-000	1A180DK0153505XZA
		Schwarz RAL 9005 - Matt black RAL 9005	180-411-200-180	1A180DK0153518XZA
		Messing Rustik - Rustic brass	180-411-200-01M	1A180DK015351MXZA

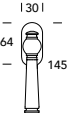
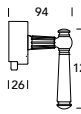
*Rastergehäuse finden Sie auf Seite 419 / For mechanism please see page 419

180DK075	Bezeichnung - Description	Farbe - Finishes	Alte art. nr - Old code	1 Stück - Piece
  	Fensterolive mit Druckknopf Ros. 30x64 inklusive Rastergehäuse mit 30 mm vorstehendem Stift <i>Dreh Kipp with push button on rose (mechanism included) and 7x30 mm spindle (mechanism included)</i>	Chrom - Polished chrome	180-075-030-000	1A180DK0753005XZA
		Schwarz RAL 9005 - Matt black RAL 9005	180-075-030-180	1A180DK0753018XZA
		Messing Rustik - Rustic brass	180-075-030-01M	1A180DK075301MXZA
	Fensterolive mit Druckknopf Ros. 30x64 inklusive Reastergehäuse mit 35 mm vorstehendem Stift <i>Dreh Kipp with push button on rose (mechanism included) and 7x35 mm spindle (mechanism included)</i>	Chrom - Polished chrome	180-075-035-000	1A180DK0753505XZA
		Schwarz RAL 9005 - Matt black RAL 9005	180-075-035-180	1A180DK0753518XZA
		Messing Rustik - Rustic brass	180-075-035-01M	1A180DK075351MXZA
	Fensterolive mit Druckknopf Ros. 30x64 mit 50 mm vorstehendem Stift <i>Dreh Kipp with push button on rose (mechanism included) and 7x50 mm spindle</i>	Chrom - Polished chrome	180-075-050-000	1A180DK0755005XZA
		Schwarz RAL 9005 - Matt black RAL 9005	180-075-050-180	1A180DK0755018XZA
		Messing Rustik - Rustic brass	180-075-050-01M	1A180DK075501MXZA

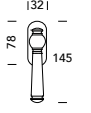
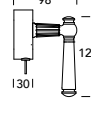
180DKC80	Bezeichnung - Description	Farbe - Finishes	Alte art. nr - Old code	1 Stück - Piece
   	Fensterolive "RC 2" zertifiziert Ros. 32x78 ohne Rastergehäuse (separat zu notieren*) DK with key RC2 certified on rose 32x78 without mechanism (to be ordered separately*)	Chrom - Polished chrome	180-C80-10E-000	1A180DKC800005XZA
		Schwarz RAL 9005 - Matt black RAL 9005	180-C80-10E-180	1A180DKC800018XZA
		Messing Rustik - Rustic brass	180-C80-10E-01M	1A180DKC80001MXZA
	Fensterolive "RC 2" zertifiziert Ros. 32x78 inklusive Rastergehäuse mit 30 mm vorstehendem Stift DK with key RC2 certified on rose 32x78 and 7x30 mm spindle (mechanism included)	Chrom - Polished chrome	180-C80-00E-000	1A180DKC803005XZA
		Schwarz RAL 9005 - Matt black RAL 9005	180-C80-00E-180	1A180DKC803018XZA
		Messing Rustik - Rustic brass	180-C80-00E-01M	1A180DKC80301MXZA
	Fensterolive "RC 2" zertifiziert Ros. 32x78 inklusive Reastergehäuse mit 35 mm vorstehendem Stift DK with key RC2 certified on rose 32x78 and 7x35 mm spindle (mechanism included)	Chrom - Polished chrome	180-C80-20E-000	1A180DKC803505XZA
		Schwarz RAL 9005 - Matt black RAL 9005	180-C80-20E-180	1A180DKC803518XZA
		Messing Rustik - Rustic brass	180-C80-20E-01M	1A180DKC80351MXZA

*Rastergehäuse finden Sie auf Seite 419 / For mechanism please see page 419

180DKT80	Bezeichnung - Description	Farbe - Finishes	Alte art. nr - Old code	1 Stück - Piece
   	Fensterolive mit TBT Funktion Ros. 32x78 ohne Rastergehäuse (separat zu notieren*) Dreh Kipp with key on rose 32x78 with TBT function without mechanism (to be ordered separately*)	Chrom - Polished chrome	180-T80-10E-000	1A180DKT800005XZA
		Schwarz RAL 9005 - Matt black RAL 9005	180-T80-10E-180	1A180DKT800018XZA
		Messing Rustik - Rustic brass	180-T80-10E-01M	1A180DKT80001MXZA
	Fensterolive mit TBT Funktion Ros. 32x78 inklusive Rastergehäuse mit 30 mm vorstehendem Stift Dreh Kipp with key on rose 32x78 with TBT function and 7x30 mm spindle (mechanism included)	Chrom - Polished chrome	180-T80-00E-000	1A180DKT803005XZA
		Schwarz RAL 9005 - Matt black RAL 9005	180-T80-00E-180	1A180DKT803018XZA
		Messing Rustik - Rustic brass	180-T80-00E-01M	1A180DKT80301MXZA
	Fensterolive mit TBT Funktion Ros. 32x78 inklusive Reastergehäuse mit 35 mm vorstehendem Stift Dreh Kipp with key on rose 32x78 with TBT function and 7x35 mm spindle (mechanism included)	Chrom - Polished chrome	180-T80-20E-000	1A180DKT803505XZA
		Schwarz RAL 9005 - Matt black RAL 9005	180-T80-20E-180	1A180DKT803518XZA
		Messing Rustik - Rustic brass	180-T80-20E-01M	1A180DKT80351MXZA

*Rastergehäuse finden Sie auf Seite 419 / For mechanism please see page 419



18
Schwarz RAL 9005
Matt black RAL 9005

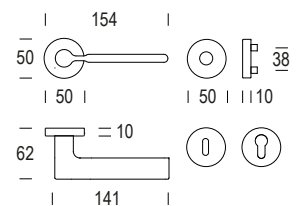

TÜRDRÜCKERGARNITUREN

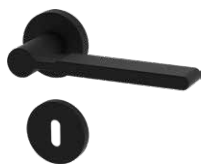

002MRD17

WECHSELGARNITUREN



002PMD01

WC GARNITUREN



002RGD17

FENSTERGRIFFE



002DK015







002DK075



002DKC80



002DKT80

002MRD17	Bezeichnung - Description	Farbe - Finishes	Alte art. nr - Old code	1 Stück - Piece
	Doppelte Bezeichnung Ø50x10 mm Schlüssellochung <i>Pair lever handle on rose Ø50x10 mm key hole</i>	Schwarz RAL 9005 - Matt black RAL 9005	002-D17-031-180	1A002MRD173118ZZA
	Doppelte Bezeichnung Ø50x10 mm PZ <i>Pair lever handle on rose Ø50x10 mm euro profile cylinder hole</i>	Schwarz RAL 9005 - Matt black RAL 9005	002-D17-032-180	1A002MRD173218ZZA
	WE-Garnitur mit Knopf J01 (420) PZ beidseitig verwendbar <i>Entrance set lever handle / knob J01 (420) Euro profile cylinder hole (LH/RH)</i>	Schwarz RAL 9005 - Matt black RAL 9005	002-D17-Y01-180	1A002PMD013218YZA
	WC-Garnitur mit Rosetten Ø50x10 mm mit Riegel 512 und Schlitzschraube 8mm VK <i>Lever handle on rose Ø50x10 mm with 512 turn and release with 8 mm spindle</i>	Schwarz RAL 9005 - Matt black RAL 9005	002-D17-900-180	1A002RGD174218ZZA

FENSTERGRIFFE - WINDOW HANDLES

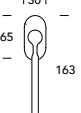
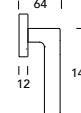
002DK015	Bezeichnung - Description	Farbe - Finishes	Alte art. nr - Old code	1 Stück - Piece
	Fensterolive ovale Ros. 30x65 ohne Rastergehäuse (separat zu notieren*) <i>Dreh Kipp on rose without mechanism (to be ordered separately*)</i>	Schwarz RAL 9005 - Matt black RAL 9005	002-411-110-180	1A002DK0150018XZA
	Fensterolive ovale Ros. 30x65 inklusive Rastergehäuse mit 30 mm vorstehendem Stift <i>Dreh Kipp on rose and 7x30 mm spindle (mechanism included)</i>	Schwarz RAL 9005 - Matt black RAL 9005	002-411-000-180	1A002DK0153018XZA
	Fensterolive ovale Ros. 30x65 inklusive Reastergehäuse mit 35 mm vorstehendem Stift <i>Dreh Kipp on rose and 7x35 mm spindle (mechanism included)</i>	Schwarz RAL 9005 - Matt black RAL 9005	002-411-200-180	1A002DK0153518XZA

*Rastergehäuse finden Sie auf Seite 419 / For mechanism please see page 419

002DK075	Bezeichnung - Description	Farbe - Finishes	Alte art. nr - Old code	1 Stück - Piece
	Fensterolive mit Druckknopf Ros. 30x64 inklusive Rastergehäuse mit 30 mm vorstehendem Stift Dreh Kipp with push button on rose (mechanism included) and 7x30 mm spindle (mechanism included)	Schwarz RAL 9005 - Matt black RAL 9005	002-075-030-180	1A002DK0753018XZA
	Fensterolive mit Druckknopf Ros. 30x64 inklusive Reastergehäuse mit 35 mm vorstehendem Stift Dreh Kipp with push button on rose (mechanism included) and 7x35 mm spindle (mechanism included)	Schwarz RAL 9005 - Matt black RAL 9005	002-075-035-180	1A002DK0753518XZA
	Fensterolive mit Druckknopf Ros. 30x64 mit 50 mm vorstehendem Stift Dreh Kipp with push button on rose (mechanism included) and 7x50 mm spindle	Schwarz RAL 9005 - Matt black RAL 9005	002-075-050-180	1A002DK0755018XZA

002DKC80	Bezeichnung - Description	Farbe - Finishes	Alte art. nr - Old code	1 Stück - Piece
	Fensterolive "RC 2" zertifiziert Ros. 32x78 ohne Rastergehäuse (separat zu notieren*) DK with key RC2 certified on rose 32x78 without mechanism (to be ordered separately*)	Schwarz RAL 9005 - Matt black RAL 9005	002-C80-10E-180	1A002DKC800018XZA
	Fensterolive "RC 2" zertifiziert Ros. 32x78 inklusive Rastergehäuse mit 30 mm vorstehendem Stift DK with key RC2 certified on rose 32x78 and 7x30 mm spindle (mechanism included)	Schwarz RAL 9005 - Matt black RAL 9005	002-C80-00E-180	1A002DKC803018XZA
	Fensterolive "RC 2" zertifiziert Ros. 32x78 inklusive Reastergehäuse mit 35 mm vorstehendem Stift DK with key RC2 certified on rose 32x78 and 7x35 mm spindle (mechanism included)	Schwarz RAL 9005 - Matt black RAL 9005	002-C80-20E-180	1A002DKC803518XZA

*Rastergehäuse finden Sie auf Seite 419 / For mechanism please see page 419

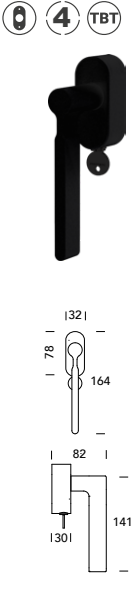
002DKT80	Bezeichnung - Description	Farbe - Finishes	Alte art. nr - Old code	1 Stück - Piece
	Fensterolive mit TBT Funktion Ros. 32x78 ohne Rastergehäuse (separat zu notieren*) Dreh Kipp with key on rose 32x78 with TBT function without mechanism (to be ordered separately*)	Schwarz RAL 9005 - Matt black RAL 9005	002-T80-10E-180	1A002DKT800018XZA
	Fensterolive mit TBT Funktion Ros. 32x78 inklusive Rastergehäuse mit 30 mm vorstehendem Stift Dreh Kipp with key on rose 32x78 with TBT function and 7x30 mm spindle (mechanism included)	Schwarz RAL 9005 - Matt black RAL 9005	002-T80-00E-180	1A002DKT803018XZA
	Fensterolive mit TBT Funktion Ros. 32x78 inklusive Reastergehäuse mit 35 mm vorstehendem Stift Dreh Kipp with key on rose 32x78 with TBT function and 7x35 mm spindle (mechanism included)	Schwarz RAL 9005 - Matt black RAL 9005	002-T80-20E-180	1A002DKT803518XZA

Maybach 001

MESSING - BRASS

Datenblatt
Datasheet



05
Chrom
Polished chrome



31
Mattnickel
Satin nickel

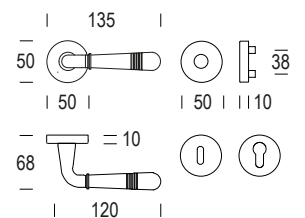

TÜRDRÜCKERGARNITUREN



001MRD17



001MR009



001MP001*

WECHSELGARNITUREN



001PMD01



001PM006*

WC GARNITUREN



001RGD17



001RG009



001PG001*

FENSTERGRIFFE



001DK015



001DK075



01DKC80

















001DKT80



GANZGLASTÜR BESCHLÄGE



R21SR

Seite 440 / page 440

001MRD17	Bezeichnung - Description	Farbe - Finishes	Alte art. nr - Old code	1 Stück - Piece
 	Doppelte Bezeichnung Ø50x10 mm Schlüssellochung <i>Pair lever handle on rose Ø50x10 mm key hole</i>	Chrom - Polished chrome	001-D17-031-000	1A001MRD173105ZZA
		Mattnickel - Satin nickel	-	1A001MRD173131ZZA
 	Doppelte Bezeichnung Ø50x10 mm PZ <i>Pair lever handle on rose Ø50x10 mm euro profile cylinder hole</i>	Chrom - Polished chrome	001-D17-032-000	1A001MRD173205ZZA
		Mattnickel - Satin nickel	-	1A001MRD173231ZZA
 	WE-Garnitur mit Knopf J01 (420) PZ beidseitig verwendbar <i>Entrance set lever handle / knob J01 (420) Euro profile cylinder hole (LH/RH)</i>	Chrom - Polished chrome	-	1A001PMD013205YZA
		Mattnickel - Satin nickel	-	1A001PMD013231YZA
 	WC-Garnitur mit Rosetten Ø50x10 mm mit Riegel 512 und Schlitzschraube 8mm VK <i>Lever handle on rose Ø50x10 mm with 512 turn and release with 8 mm spindle</i>	Chrom - Polished chrome	001-D17-900-000	1A001RGD174205ZZA
		Mattnickel - Satin nickel	-	1A001RGD174231ZZA
 	Doppelte Bezeichnung 32x62x10 mm Schlüssellochung <i>Pair lever handle on rose 32x62x10 mm key hole</i>	Chrom - Polished chrome	001-009-031-000	1A001MR0093105DZA
		Mattnickel - Satin nickel	-	1A001MR0093131DZA
 	Doppelte Bezeichnung 32x62x10 mm PZ <i>Pair lever handle on rose 32x62x10 mm euro profile cylinder hole</i>	Chrom - Polished chrome	001-009-032-000	1A001MR0093205DZA
		Mattnickel - Satin nickel	-	1A001MR0093231DZA
 	WC-Garnitur mit ovale Rosetten 32x62x10 mm mit Riegel 512 und Schlitzschraube 8mm VK <i>Lever handle on oval rose 32x62x10 mm with 512 turn and release with 8 mm spindle</i>	Chrom - Polished chrome	001-009-900-000	1A001RG0094205DZA
		Mattnickel - Satin nickel	-	1A001RG0094231DZA

001MP001	Bezeichnung - Description	Farbe - Finishes	Alte art. nr - Old code	1 Stück - Piece
	ZT-Garnitur mit Schild 43x231 mm mit BB 72 mm <i>Pair lever handle on plate Lever handle on plate mm 43x231 with BB key hole 72mm</i>	Mattnickel - Satin nickel	-	1A001MP001B631XZA
	ZT-Garnitur mit Schild 43x231 mm mit PZ 72 mm <i>Pair lever handle on plate Lever handle on plate mm 43x231 with Euro Profile cylinder hole 72mm</i>	Mattnickel - Satin nickel	-	1A001MP0011331XZA
	WE-Garnitur mit Knopf E56 72 mm PZ rechtszeigend <i>Entrance set lever handle / knob E56 with Euro Profile cylinder hole 72mm (right hand)</i>	Mattnickel - Satin nickel	-	1A001PM0061331JZA
	WE-Garnitur mit Knopf E56 72 mm PZ linkszeigend <i>Entrance set lever handle / knob E56 with Euro Profile cylinder hole 72mm (left hand)</i>	Mattnickel - Satin nickel	-	1A001PM0061331LZA
	WC-Garnitur mit Schild 43x231 mm, Riegel 512 & Schlitzschraube 8mm VK <i>Lever handle on plate mm 43x231 with 512 turn and release (8mm WC spindle)</i>	Mattnickel - Satin nickel	-	1A001PG0012431VZA

FENSTERGRIFFE - WINDOW HANDLES

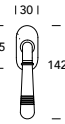
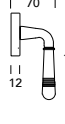
001DK015	Bezeichnung - Description	Farbe - Finishes	Alte art. nr - Old code	1 Stück - Piece
  	Fensterolive ovale Ros. 30x65 ohne Rastergehäuse (separat zu notieren*) <i>Dreh Kipp on rose without mechanism (to be ordered separately*)</i>	Chrom - Polished chrome	001-411-110-000	1A001DK0150005XZA
		Mattnickel - Satin nickel	-	1A001DK0150031XZA
	Fensterolive ovale Ros. 30x65 inklusive Rastergehäuse mit 30 mm vorstehendem Stift <i>Dreh Kipp on rose and 7x30 mm spindle (mechanism included)</i>	Chrom - Polished chrome	001-411-000-000	1A001DK0153005XZA
		Mattnickel - Satin nickel	-	1A001DK0153031XZA
	Fensterolive ovale Ros. 30x65 inklusive Reastergehäuse mit 35 mm vorstehendem Stift <i>Dreh Kipp on rose and 7x35 mm spindle (mechanism included)</i>	Chrom - Polished chrome	001-411-200-000	1A001DK0153505XZA
		Mattnickel - Satin nickel	-	1A001DK0153531XZA

*Rastergehäuse finden Sie auf Seite 419 / For mechanism please see page 419

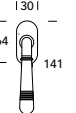
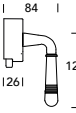
001DK075	Bezeichnung - Description	Farbe - Finishes	Alte art. nr - Old code	1 Stück - Piece
  	Fensterolive mit Druckknopf Ros. 30x64 inklusive Rastergehäuse mit 30 mm vorstehendem Stift <i>Dreh Kipp with push button on rose (mechanism included) and 7x30 mm spindle (mechanism included)</i>	Chrom - Polished chrome	001-075-030-000	1A001DK0753005XZA
		Mattnickel - Satin nickel	-	1A001DK0753031XZA
	Fensterolive mit Druckknopf Ros. 30x64 inklusive Reastergehäuse mit 35 mm vorstehendem Stift <i>Dreh Kipp with push button on rose (mechanism included) and 7x35 mm spindle (mechanism included)</i>	Chrom - Polished chrome	001-075-035-000	1A001DK0753505XZA
		Mattnickel - Satin nickel	-	1A001DK0753531XZA
	Fensterolive mit Druckknopf Ros. 30x64 mit 50 mm vorstehendem Stift <i>Dreh Kipp with push button on rose (mechanism included) and 7x50 mm spindle</i>	Chrom - Polished chrome	001-075-050-000	1A001DK0755005XZA
		Mattnickel - Satin nickel	-	1A001DK0755031XZA

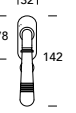
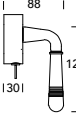
001DKC80	Bezeichnung - Description	Farbe - Finishes	Alte art. nr - Old code	1 Stück - Piece
  	Fensterolive "RC 2" zertifiziert Ros. 32x78 ohne Rastergehäuse (separat zu notieren*) <i>DK with key RC2 certified on rose 32x78 without mechanism (to be ordered separately*)</i>	Chrom - Polished chrome	001-C80-10E-000	1A001DKC800005XZA
		Mattnickel - Satin nickel	-	1A001DKC800031XZA
	Fensterolive "RC 2" zertifiziert Ros. 32x78 inklusive Rastergehäuse mit 30 mm vorstehendem Stift <i>DK with key RC2 certified on rose 32x78 and 7x30 mm spindle (mechanism included)</i>	Chrom - Polished chrome	001-C80-00E-000	1A001DKC803005XZA
		Mattnickel - Satin nickel	-	1A001DKC803031XZA
	Fensterolive "RC 2" zertifiziert Ros. 32x78 inklusive Reastergehäuse mit 35 mm vorstehendem Stift <i>DK with key RC2 certified on rose 32x78 and 7x35 mm spindle (mechanism included)</i>	Chrom - Polished chrome	001-C80-20E-000	1A001DKC803505XZA
		Mattnickel - Satin nickel	-	1A001DKC803531XZA

*Rastergehäuse finden Sie auf Seite 419 / For mechanism please see page 419

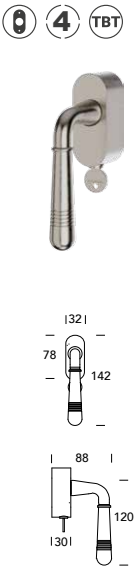
001DKT80	Bezeichnung - Description	Farbe - Finishes	Alte art. nr - Old code	1 Stück - Piece
	Fensterolive mit TBT Funktion Ros. 32x78 ohne Rastergehäuse (separat zu notieren*) <i>Dreh Kipp with key on rose</i> <i>32x78 with TBT function without</i> <i>mechanism (to be ordered</i> <i>separately*)</i>	Chrom - Polished chrome	001-T80-10E-000	1A001DKT800005XZA
		Mattnickel - Satin nickel	-	1A001DKT800031XZA
	Fensterolive mit TBT Funktion Ros. 32x78 inklusive Rastergehäuse mit 30 mm vorstehendem Stift <i>Dreh Kipp with key on rose 32x78</i> <i>with TBT function and 7x30 mm</i> <i>spindle (mechanism included)</i>	Chrom - Polished chrome	001-T80-00E-000	1A001DKT803005XZA
		Mattnickel - Satin nickel	-	1A001DKT803031XZA
	Fensterolive mit TBT Funktion Ros. 32x78 inklusive Rastergehäuse mit 35 mm vorstehendem Stift <i>Dreh Kipp with key on rose 32x78</i> <i>with TBT function and 7x35 mm</i> <i>spindle (mechanism included)</i>	Chrom - Polished chrome	001-T80-20E-000	1A001DKT803505XZA
		Mattnickel - Satin nickel	-	1A001DKT803531XZA

*Rastergehäuse finden Sie auf Seite 419 / For mechanism please see page 419

Meteor Eckig J08

MESSING - BRASS

Datenblatt
Datasheet



F6
Edelstahl / Chrom
Stainless steel / Chrome

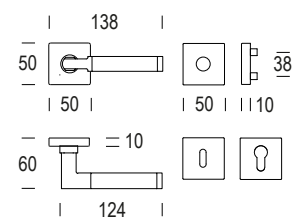

TÜRDRÜCKERGARNITUREN



J08MRQD7

WECHSELGARNITUREN











J08PMD03

WC GARNITUREN



J08RQQD7

J08MRQD7	Bezeichnung - Description	Farbe - Finishes	Alte art. nr - Old code	1 Stück - Piece
 	Doppelte Bezeichnung 50x50x10 mm Schlüssellochung <i>Pair lever handle on rose 50x50x10 mm key hole</i>	Chrom/Edelstahl - Polished chrome/Stainless steel 304	463-QD7-031-035	1AJ08MRQD731F6ZZA
 	Doppelte Bezeichnung 50x50x10 mm PZ <i>Pair lever handle on rose 50x50x10 mm euro profile cylinder hole</i>	Chrom/Edelstahl - Polished chrome/Stainless steel 304	463-QD7-032-035	1AJ08MRQD732F6ZZA
 	WE-Garnitur mit Knopf J03 (373) PZ beidseitig verwendbar <i>Entrance set lever handle / knob J03 (373) Euro profile cylinder hole (LH/RH)</i>	Chrom/Edelstahl - Polished chrome/Stainless steel 304	463-QD7-Y03-035	1AJ08PMD0332F6YZA
 	WC-Garnitur mit quadratische Rosette 50x50x10 mm mit Riegel 124 und Schlitzschraube 8mm VK <i>Lever handle on rose 50x50x10 mm with 124 turn and release with 8 mm spindle</i>	Chrom/Edelstahl - Polished chrome/Stainless steel 304	463-QD7-900-035	1AJ08RQQD742F6ZZA



Meteor Rund J08

MESSING - BRASS

Datenblatt
Datasheet



F6
Edelstahl / Chrom
Stainless steel / Chrome

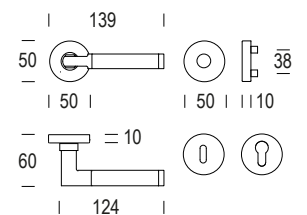

TÜRDRÜCKERGARNITUREN



J08MRD17

WECHSELGARNITUREN



J08PMD01

WC GARNITUREN



J08RGD17

FENSTERGRIFFE



J08DK015



J08DK075



J08DKC80







J08DKT80

GANZGLASTÜR BESCHLÄGE



C41SR



Seite 441 / page 441

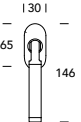
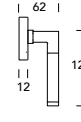

J08MRD17	Bezeichnung - Description	Farbe - Finishes	Alte art. nr - Old code	1 Stück - Piece
	Doppelte Bezeichnung Ø50x10 mm Schlüssellochung <i>Pair lever handle on rose Ø50x10 mm key hole</i>	Chrom/Edelstahl - Polished chrome/Stainless steel 304	463-D17-031-035	1AJ08MRD1731F6ZZA
	Doppelte Bezeichnung Ø50x10 mm PZ <i>Pair lever handle on rose Ø50x10 mm euro profile cylinder hole</i>	Chrom/Edelstahl - Polished chrome/Stainless steel 304	463-D17-032-035	1AJ08MRD1732F6ZZA
	WE-Garnitur mit Knopf J01 (420) PZ beidseitig verwendbar <i>Entrance set lever handle / knob J01 (420) Euro profile cylinder hole (LH/RH)</i>	Chrom/Edelstahl - Polished chrome/Stainless steel 304	463-D17-Y01-035	1AJ08PMD0132F6YZA
	WC-Garnitur mit Rosetten Ø50x10 mm mit Riegel 512 und Schlitzschraube 8mm VK <i>Lever handle on rose Ø50x10 mm with 512 turn and release with 8 mm spindle</i>	Chrom/Edelstahl - Polished chrome/Stainless steel 304	463-D17-900-035	1AJ08RGD1742F6ZZA

FENSTERGRIFFE - WINDOW HANDLES

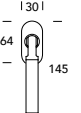
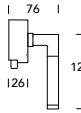

J08DK015	Bezeichnung - Description	Farbe - Finishes	Alte art. nr - Old code	1 Stück - Piece
	Fensterolive ovale Ros. 30x65 ohne Rastergehäuse (separat zu notieren*) <i>Dreh Kipp on rose without mechanism (to be ordered separately*)</i>	Chrom/Edelstahl - Polished chrome/Stainless steel 304	-	1AJ08DK01500F6XZA
	Fensterolive ovale Ros. 30x65 inklusive Rastergehäuse mit 30 mm vorstehendem Stift <i>Dreh Kipp on rose and 7x30 mm spindle (mechanism included)</i>	Chrom/Edelstahl - Polished chrome/Stainless steel 304	463-411-000-035	1AJ08DK01530F6XZA
	Fensterolive ovale Ros. 30x65 inklusive Reastergehäuse mit 35 mm vorstehendem Stift <i>Dreh Kipp on rose and 7x35 mm spindle (mechanism included)</i>	Chrom/Edelstahl - Polished chrome/Stainless steel 304	463-411-200-035	1AJ08DK01535F6XZA

*Rastergehäuse finden Sie auf Seite 419 / For mechanism please see page 419

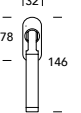
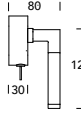
J08DK075	Bezeichnung - Description	Farbe - Finishes	Alte art. nr - Old code	1 Stück - Piece
   	Fensterolive mit Druckknopf Ros. 30x64 inklusive Rastergehäuse mit 30 mm vorstehendem Stift <i>Dreh Kipp with push button on rose (mechanism included) and 7x30 mm spindle (mechanism included)</i>	Chrom/Edelstahl - Polished chrome/Stainless steel 304	463-075-030-035	1AJ08DK07530F6XZA
	Fensterolive mit Druckknopf Ros. 30x64 inklusive Reastergehäuse mit 35 mm vorstehendem Stift <i>Dreh Kipp with push button on rose (mechanism included) and 7x35 mm spindle (mechanism included)</i>	Chrom/Edelstahl - Polished chrome/Stainless steel 304	-	1AJ08DK07535F6XZA
	Fensterolive mit Druckknopf Ros. 30x64 mit 50 mm vorstehendem Stift <i>Dreh Kipp with push button on rose (mechanism included) and 7x50 mm spindle</i>	Chrom/Edelstahl - Polished chrome/Stainless steel 304	463-075-050-035	1AJ08DK07550F6XZA

J08DKC80	Bezeichnung - Description	Farbe - Finishes	Alte art. nr - Old code	1 Stück - Piece
   	Fensterolive "RC 2" zertifiziert Ros. 32x78 ohne Rastergehäuse (separat zu notieren*) <i>DK with key RC2 certified on rose 32x78 without mechanism (to be ordered separately*)</i>	Chrom/Edelstahl - Polished chrome/Stainless steel 304	463-C80-10E-035	1AJ08DKC8000F6XZA
	Fensterolive "RC 2" zertifiziert Ros. 32x78 inklusive Rastergehäuse mit 30 mm vorstehendem Stift <i>DK with key RC2 certified on rose 32x78 and 7x30 mm spindle (mechanism included)</i>	Chrom/Edelstahl - Polished chrome/Stainless steel 304	463-C80-00E-035	1AJ08DKC8030F6XZA
	Fensterolive "RC 2" zertifiziert Ros. 32x78 inklusive Reastergehäuse mit 35 mm vorstehendem Stift <i>DK with key RC2 certified on rose 32x78 and 7x35 mm spindle (mechanism included)</i>	Chrom/Edelstahl - Polished chrome/Stainless steel 304	463-C80-20E-035	1AJ08DKC8035F6XZA

*Rastergehäuse finden Sie auf Seite 419 / For mechanism please see page 419

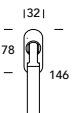
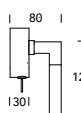
J08DKT80	Bezeichnung - Description	Farbe - Finishes	Alte art. nr - Old code	1 Stück - Piece
   	Fensterolive mit TBT Funktion Ros. 32x78 ohne Rastergehäuse (separat zu notieren*) <i>Dreh Kipp with key on rose 32x78 with TBT function without mechanism (to be ordered separately*)</i>	Chrom/Edelstahl - Polished chrome/Stainless steel 304	463-T80-10E-035	1AJ08DKT8000F6XZA
	Fensterolive mit TBT Funktion Ros. 32x78 inklusive Rastergehäuse mit 30 mm vorstehendem Stift <i>Dreh Kipp with key on rose 32x78 with TBT function and 7x30 mm spindle (mechanism included)</i>	Chrom/Edelstahl - Polished chrome/Stainless steel 304	463-T80-00E-035	1AJ08DKT8030F6XZA
	Fensterolive mit TBT Funktion Ros. 32x78 inklusive Reastergehäuse mit 35 mm vorstehendem Stift <i>Dreh Kipp with key on rose 32x78 with TBT function and 7x35 mm spindle (mechanism included)</i>	Chrom/Edelstahl - Polished chrome/Stainless steel 304	463-T80-20E-035	1AJ08DKT8035F6XZA

*Rastergehäuse finden Sie auf Seite 419 / For mechanism please see page 419

New Orbis J07

MESSING - BRASS

Datenblatt
Datasheet



26
Messing Poliert / Chrom
Polished varnished / Chrome



5E
Messing Poliert / Edelstahl
Polished varnished / Stainless
steel



F6
Edelstahl / Chrom
Stainless steel / Chrome

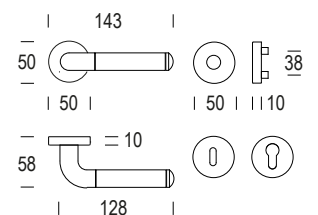
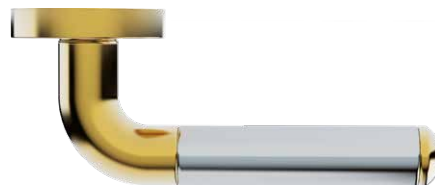

TÜRDRÜCKERGARNITUREN



J07MRD17

WECHSELGARNITUREN



J07PMD01

WC GARNITUREN



J07RGD17

FENSTERGRIFFE



J07DK015











J07DK075



J07DKC80



J07DKT80

J07MRD17	Bezeichnung - Description	Farbe - Finishes	Alte art. nr - Old code	1 Stück - Piece
 	Doppelte Bezeichnung Ø50x10 mm Schlüssellochung Pair lever handle on rose Ø50x10 mm key hole	Messing Poliert/Chrom - Pol. varnished/Pol. chrome	444-D17-031-010	1AJ07MRD173126ZZA
		Messing Poliert/Edelstahl - Pol. varnished/Stainless steel	444-D17-031-036	1AJ07MRD17315EZZA
		Chrom/Edelstahl - Polished chrome/Stainless steel 304	444-D17-031-035	1AJ07MRD1731F6ZZA
 	Doppelte Bezeichnung Ø50x10 mm PZ Pair lever handle on rose Ø50x10 mm euro profile cylinder hole	Messing Poliert/Chrom - Pol. varnished/Pol. chrome	444-D17-032-010	1AJ07MRD173226ZZA
		Messing Poliert/Edelstahl - Pol. varnished/Stainless steel	444-D17-032-036	1AJ07MRD17325EZZA
		Chrom/Edelstahl - Polished chrome/Stainless steel 304	444-D17-032-035	1AJ07MRD1732F6ZZA
 	WE-Garnitur mit Knopf J01 (420) PZ beidseitig verwendbar Entrance set lever handle / knob J01 (420) Euro profile cylinder hole (LH/RH)	Messing Poliert/Chrom - Pol. varnished/Pol. chrome	444-D17-Y01-010	1AJ07PMD013226YZA
		Messing Poliert/Edelstahl - Pol. varnished/Stainless steel	444-D17-Y01-036	1AJ07PMD01325EYZA
		Chrom/Edelstahl - Polished chrome/Stainless steel 304	444-D17-Y01-035	1AJ07PMD0132F6YZA
 	WC-Garnitur mit Rosetten Ø50x10 mm mit Riegel 512 und Schlitzschraube 8mm VK Lever handle on rose Ø50x10 mm with 512 turn and release with 8 mm spindle	Messing Poliert/Chrom - Pol. varnished/Pol. chrome	444-D17-900-010	1AJ07RGD174226ZZA
		Messing Poliert/Edelstahl - Pol. varnished/Stainless steel	444-D17-900-036	1AJ07RGD17425EZZA
		Chrom/Edelstahl - Polished chrome/Stainless steel 304	444-D17-900-035	1AJ07RGD1742F6ZZA

FENSTERGRIFFE - WINDOW HANDLES

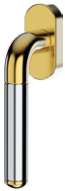
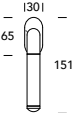
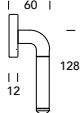
J07DK015	Bezeichnung - Description	Farbe - Finishes	Alte art. nr - Old code	1 Stück - Piece
 	Fensterolive ovale Ros. 30x65 ohne Rastergehäuse (separat zu notieren*) Dreh Kipp on rose without mechanism (to be ordered separately*)	Messing Poliert/Chrom - Pol. varnished/Pol. chrome	444-411-110-010	1AJ07DK0150026XZA
		Messing Poliert/Edelstahl - Pol. varnished/Stainless steel	444-411-110-036	1AJ07DK015005EXZA
		Chrom/Edelstahl - Polished chrome/Stainless steel 304	444-411-110-035	1AJ07DK01500F6XZA
	Fensterolive ovale Ros. 30x65 inklusive Rastergehäuse mit 30 mm vorstehendem Stift Dreh Kipp on rose and 7x30 mm spindle (mechanism included)	Messing Poliert/Chrom - Pol. varnished/Pol. chrome	444-411-000-010	1AJ07DK0153026XZA
		Messing Poliert/Edelstahl - Pol. varnished/Stainless steel	444-411-000-036	1AJ07DK015305EXZA
		Chrom/Edelstahl - Polished chrome/Stainless steel 304	444-411-000-035	1AJ07DK01530F6XZA
	Fensterolive ovale Ros. 30x65 inklusive Rastergehäuse mit 35 mm vorstehendem Stift Dreh Kipp on rose and 7x35 mm spindle (mechanism included)	Messing Poliert/Chrom - Pol. varnished/Pol. chrome	444-411-200-010	1AJ07DK0153526XZA
		Messing Poliert/Edelstahl - Pol. varnished/Stainless steel	444-411-200-036	1AJ07DK015355EXZA
		Chrom/Edelstahl - Polished chrome/Stainless steel 304	444-411-200-035	1AJ07DK01535F6XZA

*Rastergehäuse finden Sie auf Seite 419 / For mechanism please see page 419

J07DK075	Bezeichnung - Description	Farbe - Finishes	Alte art. nr - Old code	1 Stück - Piece
	Fensterolive mit Druckknopf Ros. 30x64 inklusive Rastergehäuse mit 30 mm vorstehendem Stift Dreh Kipp with push button on rose (mechanism included) and 7x30 mm spindle (mechanism included)	Messing Poliert/Chrom - Pol. varnished/Pol. chrome	444-075-030-010	1AJ07DK0753026XZA
		Messing Poliert/Edelstahl - Pol. varnished/Stainless steel	444-075-030-036	1AJ07DK075305EXZA
		Chrom/Edelstahl - Polished chrome/Stainless steel 304	444-075-030-035	1AJ07DK07530F6XZA
	Fensterolive mit Druckknopf Ros. 30x64 inklusive Reastergehäuse mit 35 mm vorstehendem Stift Dreh Kipp with push button on rose (mechanism included) and 7x35 mm spindle (mechanism included)	Messing Poliert/Chrom - Pol. varnished/Pol. chrome	444-075-035-010	1AJ07DK0753526XZA
		Messing Poliert/Edelstahl - Pol. varnished/Stainless steel	444-075-035-036	1AJ07DK075355EXZA
		Chrom/Edelstahl - Polished chrome/Stainless steel 304	444-075-035-035	1AJ07DK07535F6XZA
	Fensterolive mit Druckknopf Ros. 30x64 mit 50 mm vorstehendem Stift Dreh Kipp with push button on rose (mechanism included) and 7x50 mm spindle	Messing Poliert/Chrom - Pol. varnished/Pol. chrome	444-075-050-010	1AJ07DK0755026XZA
		Messing Poliert/Edelstahl - Pol. varnished/Stainless steel	444-075-050-036	1AJ07DK075505EXZA
		Chrom/Edelstahl - Polished chrome/Stainless steel 304	444-075-050-035	1AJ07DK07550F6XZA

J07DKC80	Bezeichnung - Description	Farbe - Finishes	Alte art. nr - Old code	1 Stück - Piece
	Fensterolive "RC 2" zertifiziert Ros. 32x78 ohne Rastergehäuse (separat zu notieren*) DK with key RC2 certified on rose 32x78 without mechanism (to be ordered separately*)	Messing Poliert/Chrom - Pol. varnished/Pol. chrome	444-C80-10E-010	1AJ07DKC800026XZA
		Messing Poliert/Edelstahl - Pol. varnished/Stainless steel	444-C80-10E-036	1AJ07DKC80005EXZA
		Chrom/Edelstahl - Polished chrome/Stainless steel 304	444-C80-10E-035	1AJ07DKC8000F6XZA
	Fensterolive "RC 2" zertifiziert Ros. 32x78 inklusive Rastergehäuse mit 30 mm vorstehendem Stift DK with key RC2 certified on rose 32x78 and 7x30 mm spindle (mechanism included)	Messing Poliert/Chrom - Pol. varnished/Pol. chrome	444-C80-00E-010	1AJ07DKC803026XZA
		Messing Poliert/Edelstahl - Pol. varnished/Stainless steel	444-C80-00E-036	1AJ07DKC80305EXZA
		Chrom/Edelstahl - Polished chrome/Stainless steel 304	444-C80-00E-035	1AJ07DKC8030F6XZA
	Fensterolive "RC 2" zertifiziert Ros. 32x78 inklusive Reastergehäuse mit 35 mm vorstehendem Stift DK with key RC2 certified on rose 32x78 and 7x35 mm spindle (mechanism included)	Messing Poliert/Chrom - Pol. varnished/Pol. chrome	444-C80-20E-010	1AJ07DKC803526XZA
		Messing Poliert/Edelstahl - Pol. varnished/Stainless steel	444-C80-20E-036	1AJ07DKC80355EXZA
		Chrom/Edelstahl - Polished chrome/Stainless steel 304	444-C80-20E-035	1AJ07DKC8035F6XZA

*Rastergehäuse finden Sie auf Seite 419 / For mechanism please see page 419

J07DKT80	Bezeichnung - Description	Farbe - Finishes	Alte art. nr - Old code	1 Stück - Piece
	Fensterolive mit TBT Funktion Ros. 32x78 ohne Rastergehäuse (separat zu notieren*) Dreh Kipp with key on rose 32x78 with TBT function without mechanism (to be ordered separately*)	Messing Poliert/Chrom - Pol. varnished/Pol. chrome	444-T80-10E-010	1AJ07DKT800026XZA
		Messing Poliert/Edelstahl - Pol. varnished/Stainless steel	444-T80-10E-036	1AJ07DKT80005EXZA
		Chrom/Edelstahl - Polished chrome/Stainless steel 304	444-T80-10E-035	1AJ07DKT8000F6XZA
	Fensterolive mit TBT Funktion Ros. 32x78 inklusive Rastergehäuse mit 30 mm vorstehendem Stift Dreh Kipp with key on rose 32x78 with TBT function and 7x30 mm spindle (mechanism included)	Messing Poliert/Chrom - Pol. varnished/Pol. chrome	444-T80-00E-010	1AJ07DKT803026XZA
		Messing Poliert/Edelstahl - Pol. varnished/Stainless steel	444-T80-00E-036	1AJ07DKT80305EXZA
		Chrom/Edelstahl - Polished chrome/Stainless steel 304	444-T80-00E-035	1AJ07DKT8030F6XZA
	Fensterolive mit TBT Funktion Ros. 32x78 inklusive Reastergehäuse mit 35 mm vorstehendem Stift Dreh Kipp with key on rose 32x78 with TBT function and 7x35 mm spindle (mechanism included)	Messing Poliert/Chrom - Pol. varnished/Pol. chrome	444-T80-20E-010	1AJ07DKT803526XZA
		Messing Poliert/Edelstahl - Pol. varnished/Stainless steel	444-T80-20E-036	1AJ07DKT80355EXZA
		Chrom/Edelstahl - Polished chrome/Stainless steel 304	444-T80-20E-035	1AJ07DKT8035F6XZA

*Rastergehäuse finden Sie auf Seite 419 / For mechanism please see page 419



NO
A-Plus Satin Schwarz
Satin black



NR
A-Plus Schwarz RAL 9005
Matt black RAL 9005



NW
A-Plus Weiß RAL 9016
Matt white RAL 9016

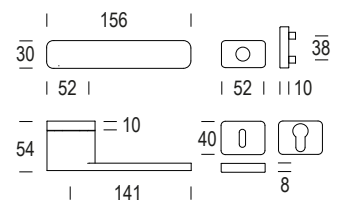

TÜRDRÜCKERGARNITUREN



10NMED1N

WECHSELGARNITUREN



10NRWD1N

STOßGRIFF



10NMD

Seite 424 / page 424

FENSTERGRIFFE









10NDKQ15





10NDKC81*



10NDKT81*

10NMRD1N	Bezeichnung - Description	Farbe - Finishes	Alte art. nr - Old code	1 Stück - Piece
 	Doppelte Bezeichnung ZT-Garnitur mit Minimal Rosetten 50x30x10 mm BB <i>Pair lever handle on rose Lever handle on minimal rose 50x30x10 mm key hole</i>	A-PLUS Plus Schwarz Satiniert - <i>Satin black</i>	10N-D1N-071-0NO	1A10NMRD1N71NODZA
		Schwarz Matt RAL 9005 - <i>Matt black RAL 9005</i>	10N-D1N-071-0NR	1A10NMRD1N71NRDZA
		Weiß Matt RAL 9016 - <i>Matt white RAL 9016</i>	10N-D1N-071-0NW	1A10NMRD1N71NWDZA
 	Doppelte Bezeichnung ZT-Garnitur mit Minimal Rosetten 50x30x10 mm PZ <i>Pair lever handle on rose Lever handle on minimal rose 50x30x10 mm Euro profile cylinder hole</i>	A-PLUS Plus Schwarz Satiniert - <i>Satin black</i>	10N-D1N-072-0NO	1A10NMRD1N72NODZA
		Schwarz Matt RAL 9005 - <i>Matt black RAL 9005</i>	10N-D1N-072-0NR	1A10NMRD1N72NRDZA
		Weiß Matt RAL 9016 - <i>Matt white RAL 9016</i>	10N-D1N-072-0NW	1A10NMRD1N72NWDZA
 	WC-Garnitur mit Minimal Rosetten 50x30x10 mm mit Riegel 503 und Schlitzschraube mit WC 6/8mm VK <i>Lever handle on minimal rose 50x30x10 mm with 503 turn and release with 6/8 mm spindle</i>	A-PLUS Plus Schwarz Satiniert - <i>Satin black</i>	10N-D1N-985-0NO	1A10NRWD1N85NODZA
		Schwarz Matt RAL 9005 - <i>Matt black RAL 9005</i>	10N-D1N-985-0NR	1A10NRWD1N85NRDZA
		Weiß Matt RAL 9016 - <i>Matt white RAL 9016</i>	10N-D1N-985-0NW	1A10NRWD1N85NWDZA

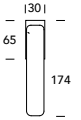
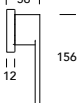

FENSTERGRIFFE - WINDOW HANDLES

10NDKQ15	Bezeichnung - Description	Farbe - Finishes	Alte art. nr - Old code	1 Stück - Piece
 	Fensterolive rechteckige Ros. 30x65 ohne Rastergehäuse (separat zu notieren*) <i>Dreh Kipp on rose without mechanism (to be ordered separately*)</i>	A-PLUS Plus Schwarz Satiniert - <i>Satin black</i>	10N-511-110-0NO	1A10NDKQ1500NOXZA
		Schwarz Matt RAL 9005 - <i>Matt black RAL 9005</i>	10N-511-110-0NR	1A10NDKQ1500NRXZA
		Weiß Matt RAL 9016 - <i>Matt white RAL 9016</i>	10N-511-110-0NW	1A10NDKQ1500NWXZA
	Fensterolive rechteckige Ros. 30x65 inklusive Rastergehäuse mit 30 mm vorstehendem Stift <i>Dreh Kipp on rose and 7x30 mm spindle (mechanism included)</i>	A-PLUS Plus Schwarz Satiniert - <i>Satin black</i>	10N-511-000-0NO	1A10NDKQ1530NOXZA
		Schwarz Matt RAL 9005 - <i>Matt black RAL 9005</i>	10N-511-000-0NR	1A10NDKQ1530NRXZA
		Weiß Matt RAL 9016 - <i>Matt white RAL 9016</i>	10N-511-000-0NW	1A10NDKQ1530NWXZA
	Fensterolive rechteckige Ros. 30x65 inklusive Reastergehäuse mit 35 mm vorstehendem Stift <i>Dreh Kipp on rose and 7x35 mm spindle (mechanism included)</i>	A-PLUS Plus Schwarz Satiniert - <i>Satin black</i>	10N-511-200-0NO	1A10NDKQ1535NOXZA
		Schwarz Matt RAL 9005 - <i>Matt black RAL 9005</i>	10N-511-200-0NR	1A10NDKQ1535NRXZA
		Weiß Matt RAL 9016 - <i>Matt white RAL 9016</i>	10N-511-200-0NW	1A10NDKQ1535NWXZA

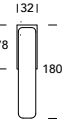
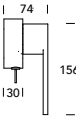
*Rastergehäuse finden Sie auf Seite 419 / For mechanism please see page 419

10NDKC81	Bezeichnung - Description	Farbe - Finishes	Alte art. nr - Old code	1 Stück - Piece
  	Fensterolive "RC 2" zertifiziert Ros. 32x78 ohne Rastergehäuse (separat zu notieren*) <i>DK with key RC2 certified on rose 32x78 without mechanism (to be ordered separately*)</i>	Schwarz Matt RAL 9005 - <i>Matt black RAL 9005</i>	10N-C81-10E-0NR	1A10NDKC8100NRXZA
		Weiß Matt RAL 9016 - <i>Matt white RAL 9016</i>	10N-C81-10E-0NW	1A10NDKC8100NWXZA
	Fensterolive "RC 2" zertifiziert Ros. 32x78 inklusive Rastergehäuse mit 30 mm vorstehendem Stift <i>DK with key RC2 certified on rose 32x78 and 7x30 mm spindle (mechanism included)</i>	Schwarz Matt RAL 9005 - <i>Matt black RAL 9005</i>	10N-C81-00E-0NR	1A10NDKC8130NRXZA
		Weiß Matt RAL 9016 - <i>Matt white RAL 9016</i>	10N-C81-00E-0NW	1A10NDKC8130NWXZA
	Fensterolive "RC 2" zertifiziert Ros. 32x78 inklusive Rastergehäuse mit 35 mm vorstehendem Stift <i>DK with key RC2 certified on rose 32x78 and 7x35 mm spindle (mechanism included)</i>	Schwarz Matt RAL 9005 - <i>Matt black RAL 9005</i>	10N-C81-20E-0NR	1A10NDKC8135NRXZA
		Weiß Matt RAL 9016 - <i>Matt white RAL 9016</i>	10N-C81-20E-0NW	1A10NDKC8135NWXZA

*Rastergehäuse finden Sie auf Seite 419 / For mechanism please see page 419

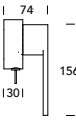
10NDKT81	Bezeichnung - Description	Farbe - Finishes	Alte art. nr - Old code	1 Stück - Piece
  	Fensterolive mit TBT Funktion Ros. 32x78 ohne Rastergehäuse (separat zu notieren*) <i>Dreh Kipp with key on rose 32x78 with TBT function without mechanism (to be ordered separately*)</i>	Schwarz Matt RAL 9005 - <i>Matt black RAL 9005</i>	10N-T81-10E-0NR	1A10NDKT8100NRXZA
		Weiß Matt RAL 9016 - <i>Matt white RAL 9016</i>	10N-T81-10E-0NW	1A10NDKT8100NWXZA
	Fensterolive mit TBT Funktion Ros. 32x78 inklusive Rastergehäuse mit 30 mm vorstehendem Stift <i>Dreh Kipp with key on rose 32x78 with TBT function and 7x30 mm spindle (mechanism included)</i>	Schwarz Matt RAL 9005 - <i>Matt black RAL 9005</i>	10N-T81-00E-0NR	1A10NDKT8130NRXZA
		Weiß Matt RAL 9016 - <i>Matt white RAL 9016</i>	10N-T81-00E-0NW	1A10NDKT8130NWXZA
	Fensterolive mit TBT Funktion Ros. 32x78 inklusive Rastergehäuse mit 35 mm vorstehendem Stift <i>Dreh Kipp with key on rose 32x78 with TBT function and 7x35 mm spindle (mechanism included)</i>	Schwarz Matt RAL 9005 - <i>Matt black RAL 9005</i>	10N-T81-20E-0NR	1A10NDKT8135NRXZA
		Weiß Matt RAL 9016 - <i>Matt white RAL 9016</i>	10N-T81-20E-0NW	1A10NDKT8135NWXZA

*Rastergehäuse finden Sie auf Seite 419 / For mechanism please see page 419

Padua J02

MESSING - BRASS

Datenblatt
Datasheet

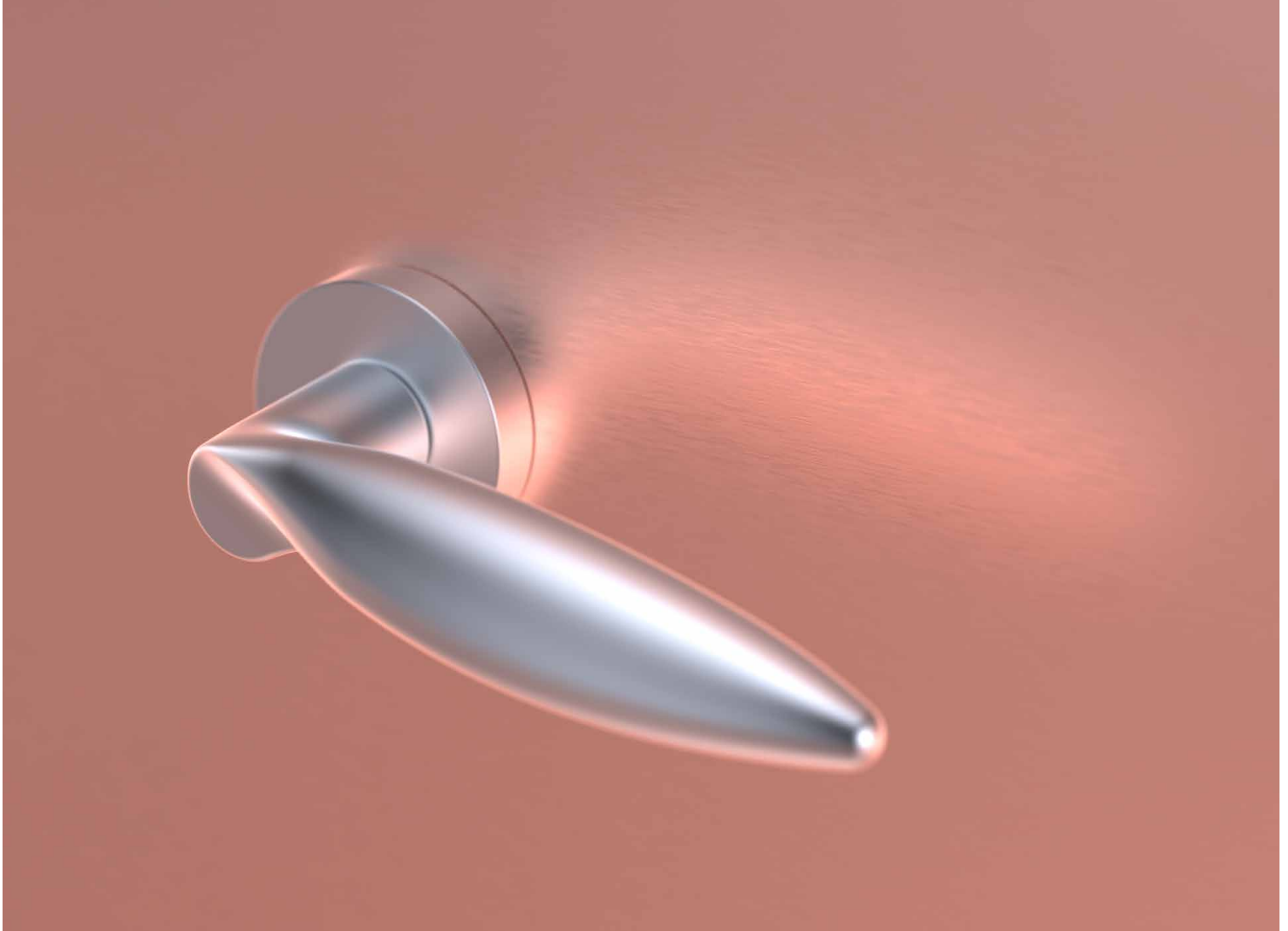

43
Velourschrom
Matt silver



31
Mattnickel
Satin nickel

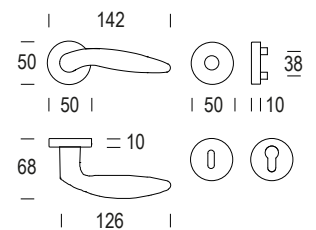

TÜRDRÜCKERGARNITUREN



J02MRD17

WECHSELGARNITUREN



J02PMD01

WC GARNITUREN



J02RGD17

FENSTERGRIFFE



J02DK015



J02DKC80



J02DKT80

J02MRD17	Bezeichnung - Description	Farbe - Finishes	Alte art. nr - Old code	1 Stück - Piece
 	Doppelte Bezeichnung Ø50x10 mm Schlüssellochung <i>Pair lever handle on rose Ø50x10 mm key hole</i>	Velourschrom - Mat Silver	467-D17-031-040	1AJ02MRD173143ZZA
		Mattnickel - Satin nickel	-	1AJ02MRD173131ZZA
 	Doppelte Bezeichnung Ø50x10 mm PZ <i>Pair lever handle on rose Ø50x10 mm euro profile cylinder hole</i>	Velourschrom - Mat Silver	467-D17-032-040	1AJ02MRD173243ZZA
		Mattnickel - Satin nickel	-	1AJ02MRD173231ZZA
 	WE-Garnitur mit Knopf J01 (420) PZ rechtszeigend <i>Entrance set lever handle / knob J01 (420) Euro profile cylinder hole (right hand)</i>	Velourschrom - Mat Silver	467-D17-400-040	1AJ02PMD013243JZA
		Mattnickel - Satin nickel	-	1AJ02PMD013231JZA
 	WE-Garnitur mit Knopf J01 (420) PZ linkszeigend <i>Entrance set lever handle / knob J01 (420) Euro profile cylinder hole (left hand)</i>	Velourschrom - Mat Silver	467-D17-300-040	1AJ02PMD013243LZA
		Mattnickel - Satin nickel	-	1AJ02PMD013231LZA
 	WC-Garnitur mit Rosetten Ø50x10 mm mit Riegel 512 und Schlitzschraube 8mm VK <i>Lever handle on rose Ø50x10 mm with 512 turn and release with 8 mm spindle</i>	Velourschrom - Mat Silver	467-D17-900-040	1AJ02RGD174243ZZA
		Mattnickel - Satin nickel	-	1AJ02RGD174231ZZA

J02DK015	Bezeichnung - Description	Farbe - Finishes	Alte art. nr - Old code	1 Stück - Piece
	Fensterlive ovale Ros. 30x65 ohne Rastergehäuse (separat zu notieren*) <i>Dreh Kipp on rose without mechanism (to be ordered separately*) (right hand)</i>	Velourschrom - <i>Mat Silver</i>	-	1AJ02DK0150043DZA
		Mattnickel - <i>Satin nickel</i>	-	1AJ02DK0150031DZA
	Fensterlive ovale Ros. 30x65 ohne Rastergehäuse (separat zu notieren*) <i>Dreh Kipp on rose without mechanism (to be ordered separately*) (left hand)</i>	Velourschrom - <i>Mat Silver</i>	-	1AJ02DK0150043SZA
		Mattnickel - <i>Satin nickel</i>	-	1AJ02DK0150031SZA
	Fensterlive ovale Ros. 30x65 inklusive Rastergehäuse mit 30 mm vorstehendem Stift <i>Dreh Kipp on rose and 7x30 mm spindle (mechanism included) (right hand)</i>	Velourschrom - <i>Mat Silver</i>	-	1AJ02DK0153043DZA
		Mattnickel - <i>Satin nickel</i>	-	1AJ02DK0153031DZA
	Fensterlive ovale Ros. 30x65 inklusive Rastergehäuse mit 30 mm vorstehendem Stift <i>Dreh Kipp on rose and 7x30 mm spindle (mechanism included) (left hand)</i>	Velourschrom - <i>Mat Silver</i>	-	1AJ02DK0153043SZA
		Mattnickel - <i>Satin nickel</i>	-	1AJ02DK0153031SZA
	Fensterlive ovale Ros. 30x65 inklusive Reastergehäuse mit 35 mm vorstehendem Stift <i>Dreh Kipp on rose and 7x35 mm spindle (mechanism included) (right hand)</i>	Velourschrom - <i>Mat Silver</i>	-	1AJ02DK0153543DZA
		Mattnickel - <i>Satin nickel</i>	-	1AJ02DK0153531DZA
	Fensterlive ovale Ros. 30x65 inklusive Reastergehäuse mit 35 mm vorstehendem Stift <i>Dreh Kipp on rose and 7x35 mm spindle (mechanism included) (left hand)</i>	Velourschrom - <i>Mat Silver</i>	-	1AJ02DK0153543SZA
		Mattnickel - <i>Satin nickel</i>	-	1AJ02DK0153531SZA

*Rastergehäuse finden Sie auf Seite 419 / For mechanism please see page 419

J02DKC80	Bezeichnung - Description	Farbe - Finishes	Alte art. nr - Old code	1 Stück - Piece
  	<p>Fensterolive "RC 2" zertifiziert Ros. 32x78 ohne Rastergehäuse (separat zu notieren*)</p> <p><i>DK with key RC2 certified on rose 32x78 without mechanism (to be ordered separately*) (right hand)</i></p>	<p>Velourschrom - <i>Mat Silver</i> Mattnickel - <i>Satin nickel</i></p>	<p>467-C80-1RE-040 -</p>	<p>1AJ02DKC800043DZA 1AJ02DKC800031DZA</p>
	<p>Fensterolive "RC 2" zertifiziert Ros. 32x78 ohne Rastergehäuse (separat zu notieren*)</p> <p><i>DK with key RC2 certified on rose 32x78 without mechanism (to be ordered separately*) (left hand)</i></p>	<p>Velourschrom - <i>Mat Silver</i> Mattnickel - <i>Satin nickel</i></p>	<p>467-C80-1LE-040 -</p>	<p>1AJ02DKC800043SZA 1AJ02DKC800031SZA</p>
	<p>Fensterolive "RC 2" zertifiziert Ros. 32x78 inklusive Rastergehäuse mit 30 mm vorstehendem Stift</p> <p><i>DK with key RC2 certified on rose 32x78 and 7x30 mm spindle (mechanism included) (right hand)</i></p>	<p>Velourschrom - <i>Mat Silver</i> Mattnickel - <i>Satin nickel</i></p>	<p>467-C80-0RE-040 -</p>	<p>1AJ02DKC803043DZA 1AJ02DKC803031DZA</p>
	<p>Fensterolive "RC 2" zertifiziert Ros. 32x78 inklusive Rastergehäuse mit 30 mm vorstehendem Stift</p> <p><i>DK with key RC2 certified on rose 32x78 and 7x30 mm spindle (mechanism included) (left hand)</i></p>	<p>Velourschrom - <i>Mat Silver</i> Mattnickel - <i>Satin nickel</i></p>	<p>467-C80-0LE-040 -</p>	<p>1AJ02DKC803043SZA 1AJ02DKC803031SZA</p>
	<p>Fensterolive "RC 2" zertifiziert Ros. 32x78 inklusive Rastergehäuse mit 35 mm vorstehendem Stift</p> <p><i>DK with key RC2 certified on rose 32x78 and 7x35 mm spindle (mechanism included) (right hand)</i></p>	<p>Velourschrom - <i>Mat Silver</i> Mattnickel - <i>Satin nickel</i></p>	<p>467-C80-2RE-040 -</p>	<p>1AJ02DKC803543DZA 1AJ02DKC803531DZA</p>
	<p>Fensterolive "RC 2" zertifiziert Ros. 32x78 inklusive Rastergehäuse mit 35 mm vorstehendem Stift</p> <p><i>DK with key RC2 certified on rose 32x78 and 7x35 mm spindle (mechanism included) (left hand)</i></p>	<p>Velourschrom - <i>Mat Silver</i> Mattnickel - <i>Satin nickel</i></p>	<p>467-C80-2LE-040 -</p>	<p>1AJ02DKC803543SZA 1AJ02DKC803531SZA</p>

*Rastergehäuse finden Sie auf Seite 419 / For mechanism please see page 419

J02DKT80	Bezeichnung - Description	Farbe - Finishes	Alte art. nr - Old code	1 Stück - Piece
	Fensterolive mit TBT Funktion Ros. 32x78 ohne Rastergehäuse (separat zu notieren*) <i>Dreh Kipp with key on rose 32x78 with TBT function without mechanism (to be ordered separately*) (right hand)</i>	Velourschrom - <i>Mat Silver</i> Mattnickel - <i>Satin nickel</i>	467-T80-1RE-040 -	1AJ02DKT800043DZA 1AJ02DKT800031DZA
	Fensterolive mit TBT Funktion Ros. 32x78 ohne Rastergehäuse (separat zu notieren*) <i>Dreh Kipp with key on rose 32x78 with TBT function without mechanism (to be ordered separately*) (left hand)</i>	Velourschrom - <i>Mat Silver</i> Mattnickel - <i>Satin nickel</i>	467-T80-1LE-040 -	1AJ02DKT800043SZA 1AJ02DKT800031SZA
	Fensterolive mit TBT Funktion Ros. 32x78 inklusive Rastergehäuse mit 30 mm vorstehendem Stift <i>Dreh Kipp with key on rose 32x78 with TBT function and 7x30 mm spindle (mechanism included) (right hand)</i>	Velourschrom - <i>Mat Silver</i> Mattnickel - <i>Satin nickel</i>	467-T80-0RE-040 -	1AJ02DKT803043DZA 1AJ02DKT803031DZA
	Fensterolive mit TBT Funktion Ros. 32x78 inklusive Rastergehäuse mit 30 mm vorstehendem Stift <i>Dreh Kipp with key on rose 32x78 with TBT function and 7x30 mm spindle (mechanism included) (left hand)</i>	Velourschrom - <i>Mat Silver</i> Mattnickel - <i>Satin nickel</i>	467-T80-0LE-040 -	1AJ02DKT803043SZA 1AJ02DKT803031SZA
	Fensterolive mit TBT Funktion Ros. 32x78 inklusive Rastergehäuse mit 35 mm vorstehendem Stift <i>Dreh Kipp with key on rose 32x78 with TBT function and 7x35 mm spindle (mechanism included) (right hand)</i>	Velourschrom - <i>Mat Silver</i> Mattnickel - <i>Satin nickel</i>	467-T80-2RE-040 -	1AJ02DKT803543DZA 1AJ02DKT803531DZA
	Fensterolive mit TBT Funktion Ros. 32x78 inklusive Rastergehäuse mit 35 mm vorstehendem Stift <i>Dreh Kipp with key on rose 32x78 with TBT function and 7x35 mm spindle (mechanism included) (left hand)</i>	Velourschrom - <i>Mat Silver</i> Mattnickel - <i>Satin nickel</i>	467-T80-2LE-040 -	1AJ02DKT803543SZA 1AJ02DKT803531SZA

*Rastergehäuse finden Sie auf Seite 419 / For mechanism please see page 419



05
Chrom
Polished chrome



18
Schwarz RAL 9005
Matt black RAL 9005



31
Mattnickel
Satin nickel

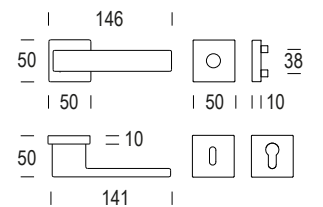

TÜRDRÜCKERGARNITUREN

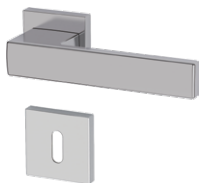

124MRQD7

WECHSELGARNITUREN



124PMD03

WC GARNITUREN

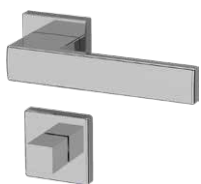

124RQQD7

FENSTERGRIFFE



124DKQ15



124DKQ75



124DKC81



124DKT81

HEBE SCHIEBTÜRGRIF SET









124MDQ01
Seite 428 / page 428

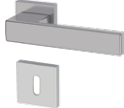

GANZGLASTÜR BESCHLÄGE



R21SR
Seite 440 / page 440

124MRQD7	Bezeichnung - Description	Farbe - Finishes	Alte art. nr - Old code	1 Stück - Piece
 	Doppelte Bezeichnung 50x50x10 mm Schlüssellochung <i>Pair lever handle on rose 50x50x10 mm key hole</i>	Chrom - Polished chrome	124-QD7-031-000	1A124MRQD73105ZZA
		Schwarz RAL 9005 - Matt black RAL 9005	124-QD7-031-180	1A124MRQD73118ZZA
		Mattnickel - Satin nickel	-	1A124MRQD73131ZZA
 	Doppelte Bezeichnung 50x50x10 mm PZ <i>Pair lever handle on rose 50x50x10 mm euro profile cylinder hole</i>	Chrom - Polished chrome	124-QD7-032-000	1A124MRQD73205ZZA
		Schwarz RAL 9005 - Matt black RAL 9005	124-QD7-032-180	1A124MRQD73218ZZA
		Mattnickel - Satin nickel	-	1A124MRQD73231ZZA
 	WE-Garnitur mit Knopf J03 (373) PZ beidseitig verwendbar <i>Entrance set lever handle / knob J03 (373) Euro profile cylinder hole (LH/RH)</i>	Chrom - Polished chrome	124-QD7-Y03-000	1A124PMD033205YZA
		Schwarz RAL 9005 - Matt black RAL 9005	124-QD7-Y03-180	1A124PMD033218YZA
		Mattnickel - Satin nickel	-	1A124PMD033231YZA
 	WC-Garnitur mit quadratische Rosette 50x50x10 mm mit Riegel 124 und Schlitzschraube 8mm VK <i>Lever handle on rose 50x50x10 mm with 124 turn and release with 8 mm spindle</i>	Schwarz RAL 9005 - Matt black RAL 9005	124-QD7-900-180	1A124RQQD74218ZZA
		Mattnickel - Satin nickel	-	1A124RQQD74231ZZA

FENSTERGRIFFE - WINDOW HANDLES

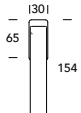
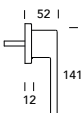
124DKQ15	Bezeichnung - Description	Farbe - Finishes	Alte art. nr - Old code	1 Stück - Piece
 	Fensterolive rechteckige Ros. 30x65 ohne Rastergehäuse (separat zu notieren*) <i>Dreh Kipp on rose without mechanism (to be ordered separately*)</i>	Chrom - Polished chrome	124-511-110-000	1A124DKQ150005XZA
		Schwarz RAL 9005 - Matt black RAL 9005	124-511-110-180	1A124DKQ150018XZA
		Mattnickel - Satin nickel	-	1A124DKQ150031XZA
	Fensterolive rechteckige Ros. 30x65 inklusive Rastergehäuse mit 30 mm vorstehendem Stift <i>Dreh Kipp on rose and 7x30 mm spindle (mechanism included)</i>	Chrom - Polished chrome	124-511-000-000	1A124DKQ153005XZA
		Schwarz RAL 9005 - Matt black RAL 9005	124-511-000-180	1A124DKQ153018XZA
		Mattnickel - Satin nickel	-	1A124DKQ153031XZA
	Fensterolive rechteckige Ros. 30x65 inklusive Reastergehäuse mit 35 mm vorstehendem Stift <i>Dreh Kipp on rose and 7x35 mm spindle (mechanism included)</i>	Chrom - Polished chrome	124-511-200-000	1A124DKQ153505XZA
		Schwarz RAL 9005 - Matt black RAL 9005	124-511-200-180	1A124DKQ153518XZA
		Mattnickel - Satin nickel	-	1A124DKQ153531XZA

*Rastergehäuse finden Sie auf Seite 419 / For mechanism please see page 419

124DKQ75	Bezeichnung - Description	Farbe - Finishes	Alte art. nr - Old code	1 Stück - Piece
	Fensterolive mit Druckknopf Ros. 30x65 inklusive Rastergehäuse mit 30 mm vorstehendem Stift Dreh Kipp with push button on rose (mechanism included) and 7x30 mm spindle (mechanism included)	Chrom - Polished chrome	124-Q75-030-000	1A124DKQ753005XZA
		Schwarz RAL 9005 - Matt black RAL 9005	124-Q75-030-180	1A124DKQ753018XZA
		Mattnickel - Satin nickel	-	1A124DKQ753031XZA
	Fensterolive mit Druckknopf Ros. 30x65 inklusive Reastergehäuse mit 35 mm vorstehendem Stift Dreh Kipp with push button on rose (mechanism included) and 7x35 mm spindle (mechanism included)	Chrom - Polished chrome	124-Q75-035-000	1A124DKQ753505XZA
		Schwarz RAL 9005 - Matt black RAL 9005	124-Q75-035-180	1A124DKQ753518XZA
		Mattnickel - Satin nickel	-	1A124DKQ753531XZA
	Fensterolive mit Druckknopf Ros. 30x65 mit 50 mm vorstehendem Stift Dreh Kipp with push button on rose (mechanism included) and 7x50 mm spindle	Chrom - Polished chrome	124-Q75-050-000	1A124DKQ755005XZA
		Schwarz RAL 9005 - Matt black RAL 9005	124-Q75-050-180	1A124DKQ755018XZA
		Mattnickel - Satin nickel	-	1A124DKQ755031XZA

124DKC81	Bezeichnung - Description	Farbe - Finishes	Alte art. nr - Old code	1 Stück - Piece
	Fensterolive "RC 2" zertifiziert Ros. 32x78 ohne Rastergehäuse (separat zu notieren*) DK with key RC2 certified on rose 32x78 without mechanism (to be ordered separately*)	Chrom - Polished chrome	124-C81-10E-000	1A124DKC810005XZA
		Schwarz RAL 9005 - Matt black RAL 9005	124-C81-10E-180	1A124DKC810018XZA
		Mattnickel - Satin nickel	-	1A124DKC810031XZA
	Fensterolive "RC 2" zertifiziert Ros. 32x78 inklusive Rastergehäuse mit 30 mm vorstehendem Stift DK with key RC2 certified on rose 32x78 and 7x30 mm spindle (mechanism included)	Chrom - Polished chrome	124-C81-00E-000	1A124DKC813005XZA
		Schwarz RAL 9005 - Matt black RAL 9005	124-C81-00E-180	1A124DKC813018XZA
		Mattnickel - Satin nickel	-	1A124DKC813031XZA
	Fensterolive "RC 2" zertifiziert Ros. 32x78 inklusive Reastergehäuse mit 35 mm vorstehendem Stift DK with key RC2 certified on rose 32x78 and 7x35 mm spindle (mechanism included)	Chrom - Polished chrome	124-C81-20E-000	1A124DKC813505XZA
		Schwarz RAL 9005 - Matt black RAL 9005	124-C81-20E-180	1A124DKC813518XZA
		Mattnickel - Satin nickel	-	1A124DKC813531XZA

*Rastergehäuse finden Sie auf Seite 419 / For mechanism please see page 419

124DKT81	Bezeichnung - Description	Farbe - Finishes	Alte art. nr - Old code	1 Stück - Piece
	Fensterolive mit TBT Funktion Ros. 32x78 ohne Rastergehäuse (separat zu notieren*) Dreh Kipp with key on rose 32x78 with TBT function without mechanism (to be ordered separately*)	Chrom - Polished chrome	124-T81-10E-000	1A124DKT810005XZA
		Schwarz RAL 9005 - Matt black RAL 9005	124-T81-10E-180	1A124DKT810018XZA
		Mattnickel - Satin nickel	-	1A124DKT810031XZA
	Fensterolive mit TBT Funktion Ros. 32x78 inklusive Rastergehäuse mit 30 mm vorstehendem Stift Dreh Kipp with key on rose 32x78 with TBT function and 7x30 mm spindle (mechanism included)	Chrom - Polished chrome	124-T81-00E-000	1A124DKT813005XZA
		Schwarz RAL 9005 - Matt black RAL 9005	124-T81-00E-180	1A124DKT813018XZA
		Mattnickel - Satin nickel	-	1A124DKT813031XZA
	Fensterolive mit TBT Funktion Ros. 32x78 inklusive Reastergehäuse mit 35 mm vorstehendem Stift Dreh Kipp with key on rose 32x78 with TBT function and 7x35 mm spindle (mechanism included)	Chrom - Polished chrome	124-T81-20E-000	1A124DKT813505XZA
		Schwarz RAL 9005 - Matt black RAL 9005	124-T81-20E-180	1A124DKT813518XZA
		Mattnickel - Satin nickel	-	1A124DKT813531XZA

*Rastergehäuse finden Sie auf Seite 419 / For mechanism please see page 419

Sandra 168

MESSING - BRASS

Datenblatt
Datasheet



◎ **P1**
Porzellan Weiß / Messing
Poliert
White porcelain / Polished
varnished



◎ **P4**
Porzellan Schwarz / Chrom
Black porcelain / Chrome



◎ **P6**
Porzellan Weiß / Chrom
White porcelain / Chrome



◎ **P7**
Porzellan Weiß / Satin Chrom
White porcelain / Satin chrome

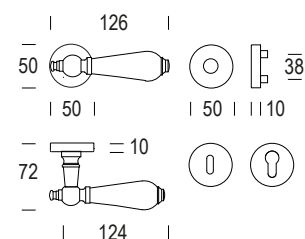

TÜRDRÜCKERGARNITUREN



168MRD17



168MP039*

WECHSELGARNITUREN



168PMD05



168PM041*

WC GARNITUREN



168RGD17



168PG039*

FENSTERGRIFFE



168DK015











168DK075



168DKC80



168DKT80

168MRD17	Bezeichnung - Description	Farbe - Finishes	Alte art. nr - Old code	1 Stück - Piece
 	Doppelte Bezeichnung Ø50x10 mm Schlüsselloch Pair lever handle on rose Ø50x10 mm key hole	Porz. Weiß/Messing Poliert - <i>White porc./Pol. varnished</i>	168-D17-031-061	1A168MRD173161ZZA
		Porz. Schwarz/Chrom - <i>Black Porc./Pol. Chrome</i>	168-D17-031-0P4	1A168MRD1731P4ZZA
		Porz. Weiß/Chrom - <i>White Porc./Pol. Chrome</i>	168-D17-031-0P6	1A168MRD1731P6ZZA
		Porz. Weiß/Satin Chrom - <i>White Porc./Satin Chrome</i>	168-D17-031-0P7	1A168MRD1731P7ZZA
 	Doppelte Bezeichnung Ø50x10 mm PZ Pair lever handle on rose Ø50x10 mm euro profile cylinder hole	Porz. Weiß/Messing Poliert - <i>White porc./Pol. varnished</i>	168-D17-032-061	1A168MRD173261ZZA
		Porz. Schwarz/Chrom - <i>Black Porc./Pol. Chrome</i>	168-D17-032-0P4	1A168MRD1732P4ZZA
		Porz. Weiß/Chrom - <i>White Porc./Pol. Chrome</i>	168-D17-032-0P6	1A168MRD1732P6ZZA
		Porz. Weiß/Satin Chrom - <i>White Porc./Satin Chrome</i>	168-D17-032-0P7	1A168MRD1732P7ZZA
 	WE-Garnitur mit Knopf E56 PZ beidseitig verwendbar Entrance set lever handle / knob E56 Euro profile cylinder hole (LH/RH)	Porz. Weiß/Messing Poliert - <i>White porc./Pol. varnished</i>	168-D17-Y56-061	1A168PMD053261YZA
		Porz. Schwarz/Chrom - <i>Black Porc./Pol. Chrome</i>	168-D17-Y56-0P4	1A168PMD0532P4YZA
		Porz. Weiß/Chrom - <i>White Porc./Pol. Chrome</i>	168-D17-Y56-0P6	1A168PMD0532P6YZA
		Porz. Weiß/Satin Chrom - <i>White Porc./Satin Chrome</i>	168-D17-Y56-0P7	1A168PMD0532P7YZA
 	WC-Garnitur mit Rosetten Ø50x10 mm mit Riegel 512 und Schlitzschraube 8mm VK Lever handle on rose Ø50x10 mm with 512 turn and release with 8 mm spindle	Porz. Weiß/Messing Poliert - <i>White porc./Pol. varnished</i>	168-D17-900-061	1A168RGD174261ZZA
		Porz. Schwarz/Chrom - <i>Black Porc./Pol. Chrome</i>	168-D17-900-0P4	1A168RGD1742P4ZZA
		Porz. Weiß/Chrom - <i>White Porc./Pol. Chrome</i>	168-D17-900-0P6	1A168RGD1742P6ZZA
		Porz. Weiß/Satin Chrom - <i>White Porc./Satin Chrome</i>	168-D17-900-0P7	1A168RGD1742P7ZZA

168MP039	Bezeichnung - Description	Farbe - Finishes	Alte art. nr - Old code	1 Stück - Piece
	ZT-Garnitur mit Schild mit IB 72 mm <i>Pair lever handle on plate with standard key hole 72mm</i>	Porz. Weiß/Messing Poliert - <i>White porc./Pol. varnished</i>	168-039-006-061	1A168MP0390661DZA
		Porz. Weiß/Satin Chrom - <i>White Porc./Satin Chrome</i>	168-039-006-0P7	1A168MP0390661DZA
	ZT-Garnitur mit Schild mit PZ 72 mm <i>Pair lever handle on plate with Euro Profile cylinder hole 72mm</i>	Porz. Weiß/Messing Poliert - <i>White porc./Pol. varnished</i>	168-039-013-061	1A168MP0391361DZA
		Porz. Weiß/Satin Chrom - <i>White Porc./Satin Chrome</i>	168-039-013-0P7	1A168MP0391361DZA
	WE-Garnitur mit Knopf E56 72 mm PZ rechtszeigend <i>Entrance set lever handle / knob E56 with Euro Profile cylinder hole 72mm (right hand)</i>	Porz. Weiß/Messing Poliert - <i>White porc./Pol. varnished</i>	168-039-D13-061	1A168PM0411361JZA
		Porz. Weiß/Satin Chrom - <i>White Porc./Satin Chrome</i>	168-039-D13-0P7	1A168PM0411361JZA
	WE-Garnitur mit Knopf E56 72 mm PZ linkszeigend <i>Entrance set lever handle / knob E56 with Euro Profile cylinder hole 72mm (left hand)</i>	Porz. Weiß/Messing Poliert - <i>White porc./Pol. varnished</i>	168-039-S13-061	1A168PM0411361LZA
		Porz. Weiß/Satin Chrom - <i>White Porc./Satin Chrome</i>	168-039-S13-0P7	1A168PM0411361LZA
	WC-Garnitur mit Schild 50x255 mm, Riegel 512 & Schlitzschraube 8mm VK <i>Pair lever handle on plate with 512 turn and release (8mm WC spindle)</i>	Porz. Weiß/Messing Poliert - <i>White porc./Pol. varnished</i>	168-039-600-061	1A168PG0392461VZA
		Porz. Weiß/Satin Chrom - <i>White Porc./Satin Chrome</i>	168-039-600-0P7	1A168PG0392461VZA

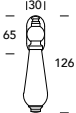
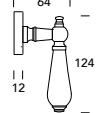
168DK015	Bezeichnung - Description	Farbe - Finishes	Alte art. nr - Old code	1 Stück - Piece
  	Fensterolive ovale Ros. 30x65 ohne Rastergehäuse (separat zu notieren*) <i>Dreh Kipp on rose without mechanism (to be ordered separately*)</i>	Porz. Weiß/Messing Poliert - <i>White porc./Pol. varnished</i>	168-411-110-061	1A168DK0150061XZA
		Porz. Schwarz/Chrom - <i>Black Porc./Pol. Chrome</i>	168-411-110-0P4	1A168DK01500P4XZA
		Porz. Weiß/Chrom - <i>White Porc./Pol. Chrome</i>	168-411-110-0P6	1A168DK01500P6XZA
		Porz. Weiß/Satin Chrom - <i>White Porc./Satin Chrome</i>	168-411-110-0P7	1A168DK01500P7XZA
	Fensterolive ovale Ros. 30x65 inklusive Rastergehäuse mit 30 mm vorstehendem Stift <i>Dreh Kipp on rose and 7x30 mm spindle (mechanism included)</i>	Porz. Weiß/Messing Poliert - <i>White porc./Pol. varnished</i>	168-411-000-061	1A168DK0153061XZA
		Porz. Schwarz/Chrom - <i>Black Porc./Pol. Chrome</i>	168-411-000-0P4	1A168DK01530P4XZA
		Porz. Weiß/Chrom - <i>White Porc./Pol. Chrome</i>	168-411-000-0P6	1A168DK01530P6XZA
		Porz. Weiß/Satin Chrom - <i>White Porc./Satin Chrome</i>	168-411-000-0P7	1A168DK01530P7XZA
	Fensterolive ovale Ros. 30x65 inklusive Reastergehäuse mit 35 mm vorstehendem Stift <i>Dreh Kipp on rose and 7x35 mm spindle (mechanism included)</i>	Porz. Weiß/Messing Poliert - <i>White porc./Pol. varnished</i>	168-411-200-061	1A168DK0153561XZA
		Porz. Schwarz/Chrom - <i>Black Porc./Pol. Chrome</i>	168-411-200-0P4	1A168DK01535P4XZA
		Porz. Weiß/Chrom - <i>White Porc./Pol. Chrome</i>	168-411-200-0P6	1A168DK01535P6XZA
		Porz. Weiß/Satin Chrom - <i>White Porc./Satin Chrome</i>	168-411-200-0P7	1A168DK01535P7XZA

*Rastergehäuse finden Sie auf Seite 419 / For mechanism please see page 419

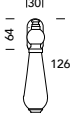
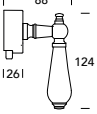
168DK075	Bezeichnung - Description	Farbe - Finishes	Alte art. nr - Old code	1 Stück - Piece
  	Fensterolive mit Druckknopf Ros. 30x64 inklusive Rastergehäuse mit 30 mm vorstehendem Stift <i>Dreh Kipp with push button on rose (mechanism included) and 7x30 mm spindle (mechanism included)</i>	Porz. Weiß/Messing Poliert - <i>White porc./Pol. varnished</i>	168-075-030-061	1A168DK0753061XZA
		Porz. Schwarz/Chrom - <i>Black Porc./Pol. Chrome</i>	168-075-030-0P4	1A168DK07530P4XZA
		Porz. Weiß/Chrom - <i>White Porc./Pol. Chrome</i>	168-075-030-0P6	1A168DK07530P6XZA
		Porz. Weiß/Satin Chrom - <i>White Porc./Satin Chrome</i>	168-075-030-0P7	1A168DK07530P7XZA
	Fensterolive mit Druckknopf Ros. 30x64 inklusive Reastergehäuse mit 35 mm vorstehendem Stift <i>Dreh Kipp with push button on rose (mechanism included) and 7x35 mm spindle (mechanism included)</i>	Porz. Weiß/Messing Poliert - <i>White porc./Pol. varnished</i>	168-075-035-061	1A168DK0753561XZA
		Porz. Schwarz/Chrom - <i>Black Porc./Pol. Chrome</i>	168-075-035-0P4	1A168DK07535P4XZA
		Porz. Weiß/Chrom - <i>White Porc./Pol. Chrome</i>	168-075-035-0P6	1A168DK07535P6XZA
		Porz. Weiß/Satin Chrom - <i>White Porc./Satin Chrome</i>	168-075-035-0P7	1A168DK07535P7XZA
	Fensterolive mit Druckknopf Ros. 30x64 mit 50 mm vorstehendem Stift <i>Dreh Kipp with push button on rose (mechanism included) and 7x50 mm spindle</i>	Porz. Weiß/Messing Poliert - <i>White porc./Pol. varnished</i>	168-075-050-061	1A168DK0755061XZA
		Porz. Schwarz/Chrom - <i>Black Porc./Pol. Chrome</i>	168-075-050-0P4	1A168DK07550P4XZA
		Porz. Weiß/Chrom - <i>White Porc./Pol. Chrome</i>	168-075-050-0P6	1A168DK07550P6XZA
		Porz. Weiß/Satin Chrom - <i>White Porc./Satin Chrome</i>	168-075-050-0P7	1A168DK07550P7XZA

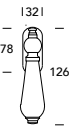
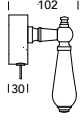
168DKC80	Bezeichnung - Description	Farbe - Finishes	Alte art. nr - Old code	1 Stück - Piece
  	Fensterolive "RC 2" zertifiziert Ros. 32x78 ohne Rastergehäuse (separat zu notieren*) DK with key RC2 certified on rose 32x78 without mechanism (to be ordered separately*)	Porz. Weiß/Messing Poliert - <i>White porc./Pol. varnished</i>	168-C80-10E-061	1A168DKC800061XZA
		Porz. Schwarz/Chrom - <i>Black Porc./Pol. Chrome</i>	168-C80-10E-0P4	1A168DKC8000P4XZA
		Porz. Weiß/Chrom - <i>White Porc./Pol. Chrome</i>	168-C80-10E-0P6	1A168DKC8000P6XZA
		Porz. Weiß/Satin Chrom - <i>White Porc./Satin Chrome</i>	168-C80-10E-0P7	1A168DKC8000P7XZA
	Fensterolive "RC 2" zertifiziert Ros. 32x78 inklusive Rastergehäuse mit 30 mm vorstehendem Stift DK with key RC2 certified on rose 32x78 and 7x30 mm spindle (mechanism included)	Porz. Weiß/Messing Poliert - <i>White porc./Pol. varnished</i>	168-C80-00E-061	1A168DKC803061XZA
		Porz. Schwarz/Chrom - <i>Black Porc./Pol. Chrome</i>	168-C80-00E-0P4	1A168DKC8030P4XZA
		Porz. Weiß/Chrom - <i>White Porc./Pol. Chrome</i>	168-C80-00E-0P6	1A168DKC8030P6XZA
		Porz. Weiß/Satin Chrom - <i>White Porc./Satin Chrome</i>	168-C80-00E-0P7	1A168DKC8030P7XZA
	Fensterolive "RC 2" zertifiziert Ros. 32x78 inklusive Reastergehäuse mit 35 mm vorstehendem Stift DK with key RC2 certified on rose 32x78 and 7x35 mm spindle (mechanism included)	Porz. Weiß/Messing Poliert - <i>White porc./Pol. varnished</i>	168-C80-20E-061	1A168DKC803561XZA
		Porz. Schwarz/Chrom - <i>Black Porc./Pol. Chrome</i>	168-C80-20E-0P4	1A168DKC8035P4XZA
		Porz. Weiß/Chrom - <i>White Porc./Pol. Chrome</i>	168-C80-20E-0P6	1A168DKC8035P6XZA
		Porz. Weiß/Satin Chrom - <i>White Porc./Satin Chrome</i>	168-C80-20E-0P7	1A168DKC8035P7XZA

*Rastergehäuse finden Sie auf Seite 419 / For mechanism please see page 419

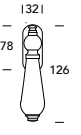
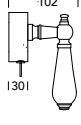
168DKT80	Bezeichnung - Description	Farbe - Finishes	Alte art. nr - Old code	1 Stück - Piece
  	Fensterolive mit TBT Funktion Ros. 32x78 ohne Rastergehäuse (separat zu notieren*) Dreh Kipp with key on rose 32x78 with TBT function without mechanism (to be ordered separately*)	Porz. Weiß/Messing Poliert - <i>White porc./Pol. varnished</i>	168-T80-10E-061	1A168DKT800061XZA
		Porz. Schwarz/Chrom - <i>Black Porc./Pol. Chrome</i>	168-T80-10E-0P4	1A168DKT8000P4XZA
		Porz. Weiß/Chrom - <i>White Porc./Pol. Chrome</i>	168-T80-10E-0P6	1A168DKT8000P6XZA
		Porz. Weiß/Satin Chrom - <i>White Porc./Satin Chrome</i>	168-T80-10E-0P7	1A168DKT8000P7XZA
	Fensterolive mit TBT Funktion Ros. 32x78 inklusive Rastergehäuse mit 30 mm vorstehendem Stift Dreh Kipp with key on rose 32x78 with TBT function and 7x30 mm spindle (mechanism included)	Porz. Weiß/Messing Poliert - <i>White porc./Pol. varnished</i>	168-T80-00E-061	1A168DKT803061XZA
		Porz. Schwarz/Chrom - <i>Black Porc./Pol. Chrome</i>	168-T80-00E-0P4	1A168DKT8030P4XZA
		Porz. Weiß/Chrom - <i>White Porc./Pol. Chrome</i>	168-T80-00E-0P6	1A168DKT8030P6XZA
		Porz. Weiß/Satin Chrom - <i>White Porc./Satin Chrome</i>	168-T80-00E-0P7	1A168DKT8030P7XZA
	Fensterolive mit TBT Funktion Ros. 32x78 inklusive Reastergehäuse mit 35 mm vorstehendem Stift Dreh Kipp with key on rose 32x78 with TBT function and 7x35 mm spindle (mechanism included)	Porz. Weiß/Messing Poliert - <i>White porc./Pol. varnished</i>	168-T80-20E-061	1A168DKT803561XZA
		Porz. Schwarz/Chrom - <i>Black Porc./Pol. Chrome</i>	168-T80-20E-0P4	1A168DKT8035P4XZA
		Porz. Weiß/Chrom - <i>White Porc./Pol. Chrome</i>	168-T80-20E-0P6	1A168DKT8035P6XZA
		Porz. Weiß/Satin Chrom - <i>White Porc./Satin Chrome</i>	168-T80-20E-0P7	1A168DKT8035P7XZA

*Rastergehäuse finden Sie auf Seite 419 / For mechanism please see page 419

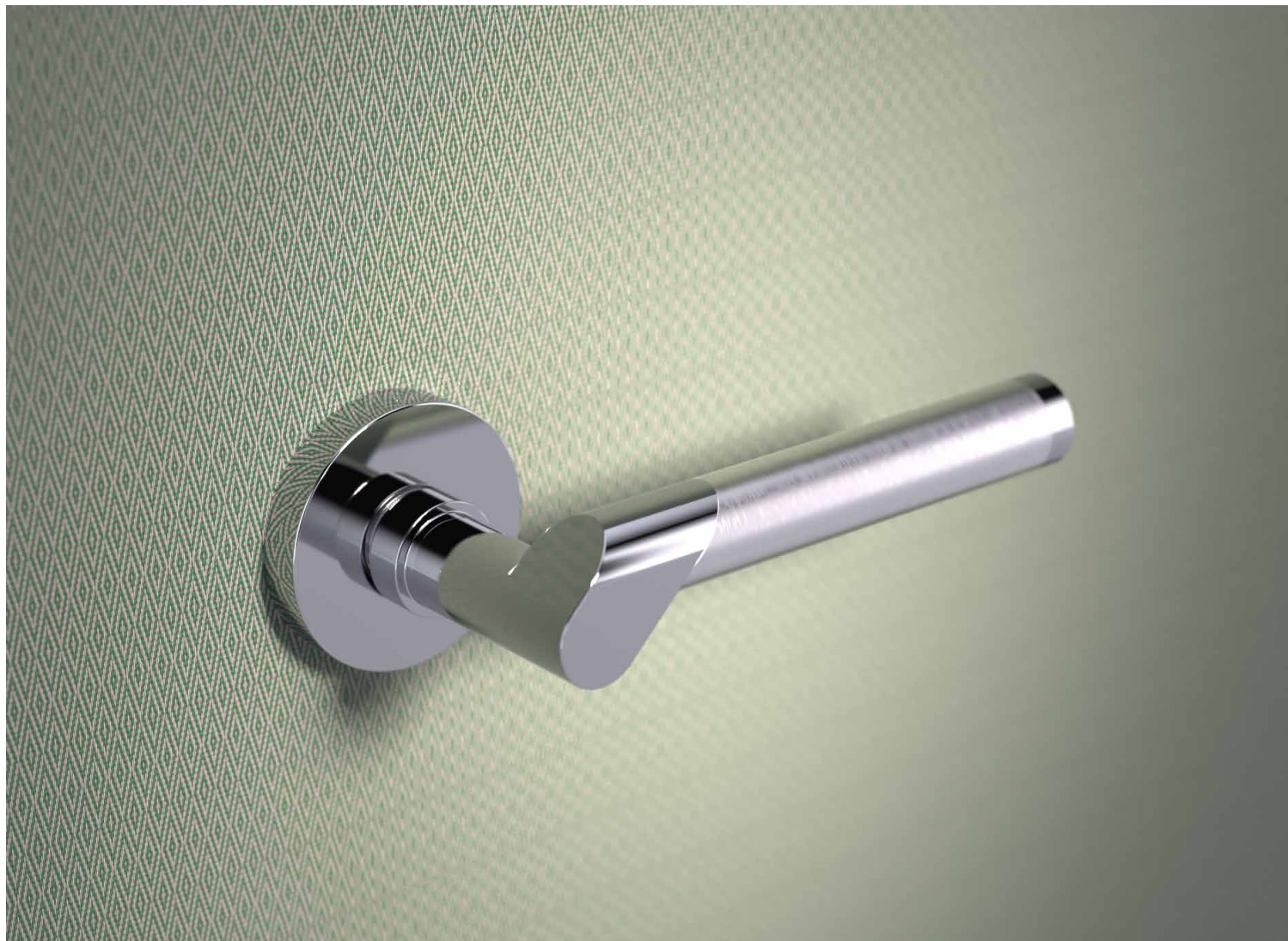

F6
Edelstahl / Chrom
Stainless steel / Chrome

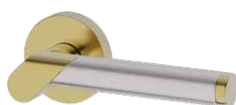

5E
Messing Poliert / Edelstahl
Polished vanished / Stainless
steel

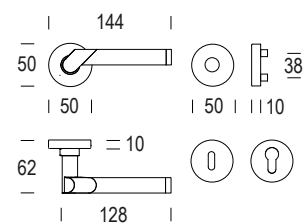

TÜRDRÜCKERGARNITUREN



J06MED17

WECHSELGARNITUREN



J06PMD01

WC GARNITUREN



J06RGD17

FENSTERGRIFFE













J06DK015



J06DKC80



J06DKT80

J06MRD17	Bezeichnung - Description	Farbe - Finishes	Alte art. nr - Old code	1 Stück - Piece
 	Doppelte Bezeichnung Ø50x10 mm Schlüsselloch <i>Pair lever handle on rose Ø50x10 mm key hole</i>	Messing Poliert/Edelstahl - <i>Pol. varnished/Stainless steel</i> Chrom/Edelstahl - <i>Polished chrome/Stainless steel 304</i>	462-D17-031-036 462-D17-031-035	1AJ06MRD17315EZZA 1AJ06MRD1731F6ZZA
 	Doppelte Bezeichnung Ø50x10 mm PZ <i>Pair lever handle on rose Ø50x10 mm euro profile cylinder hole</i>	Messing Poliert/Edelstahl - <i>Pol. varnished/Stainless steel</i> Chrom/Edelstahl - <i>Polished chrome/Stainless steel 304</i>	462-D17-032-036 462-D17-032-035	1AJ06MRD17325EZZA 1AJ06MRD1732F6ZZA
 	WE-Garnitur mit Knopf J01 (420) PZ rechtszeigend <i>Entrance set lever handle / knob J01 (420) Euro profile cylinder hole (right hand)</i>	Messing Poliert/Edelstahl - <i>Pol. varnished/Stainless steel</i> Chrom/Edelstahl - <i>Polished chrome/Stainless steel 304</i>	462-D17-400-036 462-D17-400-035	1AJ06PMD01325EJZA 1AJ06PMD0132F6JZA
 	WE-Garnitur mit Knopf J01 (420) PZ linkszeigend <i>Entrance set lever handle / knob J01 (420) Euro profile cylinder hole (left hand)</i>	Messing Poliert/Edelstahl - <i>Pol. varnished/Stainless steel</i> Chrom/Edelstahl - <i>Polished chrome/Stainless steel 304</i>	462-D17-300-036 462-D17-300-035	1AJ06PMD01325ELZA 1AJ06PMD0132F6LZA
 	WC-Garnitur mit Rosetten Ø50x10 mm mit Riegel 512 und Schlitzschraube 8mm VK <i>Lever handle on rose Ø50x10 mm with 512 turn and release with 8 mm spindle</i>	Messing Poliert/Edelstahl - <i>Pol. varnished/Stainless steel</i> Chrom/Edelstahl - <i>Polished chrome/Stainless steel 304</i>	462-D17-900-036 462-D17-900-035	1AJ06RGD17425EZZA 1AJ06RGD1742F6ZZA

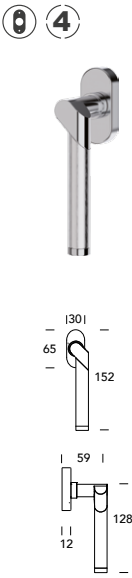
J06DK015	Bezeichnung - Description	Farbe - Finishes	Alte art. nr - Old code	1 Stück - Piece
	Fensterlive ovale Ros. 30x65 ohne Rastergehäuse (separat zu notieren*) <i>Dreh Kipp on rose without mechanism (to be ordered separately*) (right hand)</i>	Messing Poliert/Edelstahl - <i>Pol. varnished/Stainless steel</i> Chrom/Edelstahl - <i>Polished chrome/Stainless steel 304</i>	462-434-110-036 462-434-110-035	1AJ06DK015005EDZA 1AJ06DK01500F6DZA
	Fensterlive ovale Ros. 30x65 ohne Rastergehäuse (separat zu notieren*) <i>Dreh Kipp on rose without mechanism (to be ordered separately*) (left hand)</i>	Messing Poliert/Edelstahl - <i>Pol. varnished/Stainless steel</i> Chrom/Edelstahl - <i>Polished chrome/Stainless steel 304</i>	462-433-110-036 462-433-110-035	1AJ06DK015005ESZA 1AJ06DK01500F6SZA
	Fensterlive ovale Ros. 30x65 inklusive Rastergehäuse mit 30 mm vorstehendem Stift <i>Dreh Kipp on rose and 7x30 mm spindle (mechanism included) (right hand)</i>	Messing Poliert/Edelstahl - <i>Pol. varnished/Stainless steel</i> Chrom/Edelstahl - <i>Polished chrome/Stainless steel 304</i>	462-434-000-036 462-434-000-035	1AJ06DK015305EDZA 1AJ06DK01530F6DZA
	Fensterlive ovale Ros. 30x65 inklusive Rastergehäuse mit 30 mm vorstehendem Stift <i>Dreh Kipp on rose and 7x30 mm spindle (mechanism included) (left hand)</i>	Messing Poliert/Edelstahl - <i>Pol. varnished/Stainless steel</i> Chrom/Edelstahl - <i>Polished chrome/Stainless steel 304</i>	462-433-000-036 462-433-000-035	1AJ06DK015305ESZA 1AJ06DK01530F6SZA
	Fensterlive ovale Ros. 30x65 inklusive Rastergehäuse mit 35 mm vorstehendem Stift <i>Dreh Kipp on rose and 7x35 mm spindle (mechanism included) (right hand)</i>	Messing Poliert/Edelstahl - <i>Pol. varnished/Stainless steel</i> Chrom/Edelstahl - <i>Polished chrome/Stainless steel 304</i>	462-434-200-036 462-434-200-035	1AJ06DK015355EDZA 1AJ06DK01535F6DZA
	Fensterlive ovale Ros. 30x65 inklusive Rastergehäuse mit 35 mm vorstehendem Stift <i>Dreh Kipp on rose and 7x35 mm spindle (mechanism included) (left hand)</i>	Messing Poliert/Edelstahl - <i>Pol. varnished/Stainless steel</i> Chrom/Edelstahl - <i>Polished chrome/Stainless steel 304</i>	462-433-200-036 462-433-200-035	1AJ06DK015355ESZA 1AJ06DK01535F6SZA

*Rastergehäuse finden Sie auf Seite 419 / For mechanism please see page 419

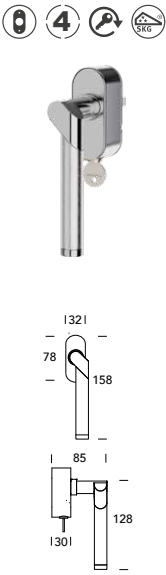
J06DKC80	Bezeichnung - Description	Farbe - Finishes	Alte art. nr - Old code	1 Stück - Piece
	<p>Fensterolive "RC 2" zertifiziert Ros. 32x78 ohne Rastergehäuse (separat zu notieren*)</p> <p><i>DK with key RC2 certified on rose 32x78 without mechanism (to be ordered separately*) (right hand)</i></p>	<p>Messing Poliert/Edelstahl - <i>Pol. varnished/Stainless steel</i> Chrom/Edelstahl - <i>Polished chrome/Stainless steel 304</i></p>	<p>462-C80-1RE-036 462-C80-1RE-035</p>	<p>1AJ06DKC80005EDZA 1AJ06DKC8000F6DZA</p>
	<p>Fensterolive "RC 2" zertifiziert Ros. 32x78 ohne Rastergehäuse (separat zu notieren*)</p> <p><i>DK with key RC2 certified on rose 32x78 without mechanism (to be ordered separately*) (left hand)</i></p>	<p>Messing Poliert/Edelstahl - <i>Pol. varnished/Stainless steel</i> Chrom/Edelstahl - <i>Polished chrome/Stainless steel 304</i></p>	<p>462-C80-1LE-036 462-C80-1LE-035</p>	<p>1AJ06DKC80005ESZA 1AJ06DKC8000F6SZA</p>
	<p>Fensterolive "RC 2" zertifiziert Ros. 32x78 inklusive Rastergehäuse mit 30 mm vorstehendem Stift</p> <p><i>DK with key RC2 certified on rose 32x78 and 7x30 mm spindle (mechanism included) (right hand)</i></p>	<p>Messing Poliert/Edelstahl - <i>Pol. varnished/Stainless steel</i> Chrom/Edelstahl - <i>Polished chrome/Stainless steel 304</i></p>	<p>462-C80-0RE-036 462-C80-0RE-035</p>	<p>1AJ06DKC80305EDZA 1AJ06DKC8030F6DZA</p>
	<p>Fensterolive "RC 2" zertifiziert Ros. 32x78 inklusive Rastergehäuse mit 30 mm vorstehendem Stift</p> <p><i>DK with key RC2 certified on rose 32x78 and 7x30 mm spindle (mechanism included) (left hand)</i></p>	<p>Messing Poliert/Edelstahl - <i>Pol. varnished/Stainless steel</i> Chrom/Edelstahl - <i>Polished chrome/Stainless steel 304</i></p>	<p>462-C80-0LE-036 462-C80-0LE-035</p>	<p>1AJ06DKC80305ESZA 1AJ06DKC8030F6SZA</p>
	<p>Fensterolive "RC 2" zertifiziert Ros. 32x78 inklusive Rastergehäuse mit 35 mm vorstehendem Stift</p> <p><i>DK with key RC2 certified on rose 32x78 and 7x35 mm spindle (mechanism included) (right hand)</i></p>	<p>Messing Poliert/Edelstahl - <i>Pol. varnished/Stainless steel</i> Chrom/Edelstahl - <i>Polished chrome/Stainless steel 304</i></p>	<p>462-C80-2RE-036 462-C80-2RE-035</p>	<p>1AJ06DKC80355EDZA 1AJ06DKC8035F6DZA</p>
	<p>Fensterolive "RC 2" zertifiziert Ros. 32x78 inklusive Rastergehäuse mit 35 mm vorstehendem Stift</p> <p><i>DK with key RC2 certified on rose 32x78 and 7x35 mm spindle (mechanism included) (left hand)</i></p>	<p>Messing Poliert/Edelstahl - <i>Pol. varnished/Stainless steel</i> Chrom/Edelstahl - <i>Polished chrome/Stainless steel 304</i></p>	<p>462-C80-2LE-036 462-C80-2LE-035</p>	<p>1AJ06DKC80355ESZA 1AJ06DKC8035F6SZA</p>

*Rastergehäuse finden Sie auf Seite 419 / For mechanism please see page 419

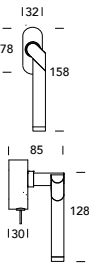
J06DKT80	Bezeichnung - Description	Farbe - Finishes	Alte art. nr - Old code	1 Stück - Piece
 	Fensterolive mit TBT Funktion Ros. 32x78 ohne Rastergehäuse (separat zu notieren*) <i>Dreh Kipp with key on rose 32x78 with TBT function without mechanism (to be ordered separately*) (right hand)</i>	Messing Poliert/Edelstahl - <i>Pol. varnished/Stainless steel</i> Chrom/Edelstahl - <i>Polished chrome/Stainless steel 304</i>	462-T80-1RE-036 462-T80-1RE-035	1AJ06DKT80005EDZA 1AJ06DKT8000F6DZA
	Fensterolive mit TBT Funktion Ros. 32x78 ohne Rastergehäuse (separat zu notieren*) <i>Dreh Kipp with key on rose 32x78 with TBT function without mechanism (to be ordered separately*) (left hand)</i>	Messing Poliert/Edelstahl - <i>Pol. varnished/Stainless steel</i> Chrom/Edelstahl - <i>Polished chrome/Stainless steel 304</i>	462-T80-1LE-036 462-T80-1LE-035	1AJ06DKT80005ESZA 1AJ06DKT8000F6SZA
	Fensterolive mit TBT Funktion Ros. 32x78 inklusive Rastergehäuse mit 30 mm vorstehendem Stift <i>Dreh Kipp with key on rose 32x78 with TBT function and 7x30 mm spindle (mechanism included) (right hand)</i>	Messing Poliert/Edelstahl - <i>Pol. varnished/Stainless steel</i> Chrom/Edelstahl - <i>Polished chrome/Stainless steel 304</i>	462-T80-0RE-036 462-T80-0RE-035	1AJ06DKT80305EDZA 1AJ06DKT8030F6DZA
	Fensterolive mit TBT Funktion Ros. 32x78 inklusive Rastergehäuse mit 30 mm vorstehendem Stift <i>Dreh Kipp with key on rose 32x78 with TBT function and 7x30 mm spindle (mechanism included) (left hand)</i>	Messing Poliert/Edelstahl - <i>Pol. varnished/Stainless steel</i> Chrom/Edelstahl - <i>Polished chrome/Stainless steel 304</i>	462-T80-0LE-036 462-T80-0LE-035	1AJ06DKT80305ESZA 1AJ06DKT8030F6SZA
	Fensterolive mit TBT Funktion Ros. 32x78 inklusive Rastergehäuse mit 35 mm vorstehendem Stift <i>Dreh Kipp with key on rose 32x78 with TBT function and 7x35 mm spindle (mechanism included) (right hand)</i>	Messing Poliert/Edelstahl - <i>Pol. varnished/Stainless steel</i> Chrom/Edelstahl - <i>Polished chrome/Stainless steel 304</i>	462-T80-2RE-036 462-T80-2RE-035	1AJ06DKT80355EDZA 1AJ06DKT8035F6DZA
	Fensterolive mit TBT Funktion Ros. 32x78 inklusive Rastergehäuse mit 35 mm vorstehendem Stift <i>Dreh Kipp with key on rose 32x78 with TBT function and 7x35 mm spindle (mechanism included) (left hand)</i>	Messing Poliert/Edelstahl - <i>Pol. varnished/Stainless steel</i> Chrom/Edelstahl - <i>Polished chrome/Stainless steel 304</i>	462-T80-2LE-036 462-T80-2LE-035	1AJ06DKT80355ESZA 1AJ06DKT8035F6SZA

*Rastergehäuse finden Sie auf Seite 419 / For mechanism please see page 419

Spring Eckig 141

TEKNOMETAL

Datenblatt
Datasheet



18
Schwarz RAL 9005
Matt black RAL 9005

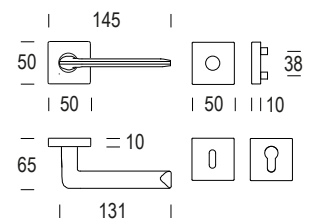

TÜRDRÜCKERGARNITUREN



141MRQD7

WECHSELGARNITUREN



141PMD03

WC GARNITUREN



141RGQD7

FENSTERGRIFFE



141DKQ15



141DKQ75



141DKC81







141DKT81

HEBE SCHIEBTÜRGRIFF





141MDQ01

Seite 430 / page 430

141MRQD7	Bezeichnung - Description	Farbe - Finishes	Alte art. nr - Old code	1 Stück - Piece
	Doppelte Bezeichnung 50x50x10 mm Schlüssellochung <i>Pair lever handle on rose 50x50x10 mm key hole</i>	Schwarz RAL 9005 - Matt black RAL 9005	141-QD7-031-180	1A141MRQD73118ZZA
	Doppelte Bezeichnung 50x50x10 mm PZ <i>Pair lever handle on rose 50x50x10 mm euro profile cylinder hole</i>	Schwarz RAL 9005 - Matt black RAL 9005	141-QD7-032-180	1A141MRQD73218ZZA
	WE-Garnitur mit Knopf J03 (373) PZ beidseitig verwendbar <i>Entrance set lever handle / knob J03 (373) Euro profile cylinder hole (LH/RH)</i>	Schwarz RAL 9005 - Matt black RAL 9005	141-QD7-Y03-180	1A141PMD033218YZA
	WC-Garnitur mit quadratische Rosette 50x50x10 mm mit Riegel 512 und Schlitzschraube 8mm VK <i>Lever handle on rose 50x50x10 mm with 512 turn and release with 8 mm spindle</i>	Schwarz RAL 9005 - Matt black RAL 9005	141-QD7-900-180	1A141RGQD74218ZZA

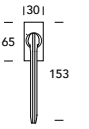
FENSTERGRIFFE - WINDOW HANDLES

141DKQ15	Bezeichnung - Description	Farbe - Finishes	Alte art. nr - Old code	1 Stück - Piece
	Fensterolive rechteckige Ros. 30x65 ohne Rastergehäuse (separat zu notieren*) <i>Dreh Kipp on rose without mechanism (to be ordered separately*)</i>	Schwarz RAL 9005 - Matt black RAL 9005	141-511-110-180	1A141DKQ150018XZA
	Fensterolive rechteckige Ros. 30x65 inklusive Rastergehäuse mit 30 mm vorstehendem Stift <i>Dreh Kipp on rose and 7x30 mm spindle (mechanism included)</i>	Schwarz RAL 9005 - Matt black RAL 9005	141-511-000-180	1A141DKQ153018XZA
	Fensterolive rechteckige Ros. 30x65 inklusive Reastergehäuse mit 35 mm vorstehendem Stift <i>Dreh Kipp on rose and 7x35 mm spindle (mechanism included)</i>	Schwarz RAL 9005 - Matt black RAL 9005	141-511-200-180	1A141DKQ153518XZA

*Rastergehäuse finden Sie auf Seite 419 / For mechanism please see page 419

141DKQ75	Bezeichnung - Description	Farbe - Finishes	Alte art. nr - Old code	1 Stück - Piece
	Fensterolive mit Druckknopf Ros. 30x65 inklusive Rastergehäuse mit 30 mm vorstehendem Stift <i>Dreh Kipp with push button on rose (mechanism included) and 7x30 mm spindle (mechanism included)</i>	Schwarz RAL 9005 - Matt black RAL 9005	141-Q75-030-180	1A141DKQ753018XZA
	Fensterolive mit Druckknopf Ros. 30x65 inklusive Reastergehäuse mit 35 mm vorstehendem Stift <i>Dreh Kipp with push button on rose (mechanism included) and 7x35 mm spindle (mechanism included)</i>	Schwarz RAL 9005 - Matt black RAL 9005	141-Q75-035-180	1A141DKQ753518XZA
	Fensterolive mit Druckknopf Ros. 30x65 mit 50 mm vorstehendem Stift <i>Dreh Kipp with push button on rose (mechanism included) and 7x50 mm spindle</i>	Schwarz RAL 9005 - Matt black RAL 9005	141-Q75-050-180	1A141DKQ755018XZA

141DKC81	Bezeichnung - Description	Farbe - Finishes	Alte art. nr - Old code	1 Stück - Piece
	Fensterolive "RC 2" zertifiziert Ros. 32x78 ohne Rastergehäuse (separat zu notieren*) <i>DK with key RC2 certified on rose 32x78 without mechanism (to be ordered separately*)</i>	Schwarz RAL 9005 - Matt black RAL 9005	141-C81-10E-180	1A141DKC810018XZA
	Fensterolive "RC 2" zertifiziert Ros. 32x78 inklusive Rastergehäuse mit 30 mm vorstehendem Stift <i>DK with key RC2 certified on rose 32x78 and 7x30 mm spindle (mechanism included)</i>	Schwarz RAL 9005 - Matt black RAL 9005	141-C81-00E-180	1A141DKC813018XZA
	Fensterolive "RC 2" zertifiziert Ros. 32x78 inklusive Reastergehäuse mit 35 mm vorstehendem Stift <i>DK with key RC2 certified on rose 32x78 and 7x35 mm spindle (mechanism included)</i>	Schwarz RAL 9005 - Matt black RAL 9005	141-C81-20E-180	1A141DKC813518XZA

*Rastergehäuse finden Sie auf Seite 419 / For mechanism please see page 419

141DKT81	Bezeichnung - Description	Farbe - Finishes	Alte art. nr - Old code	1 Stück - Piece
	Fensterolive mit TBT Funktion Ros. 32x78 ohne Rastergehäuse (separat zu notieren*) <i>Dreh Kipp with key on rose 32x78 with TBT function without mechanism (to be ordered separately*)</i>	Schwarz RAL 9005 - Matt black RAL 9005	141-T81-10E-180	1A141DKT810018XZA
	Fensterolive mit TBT Funktion Ros. 32x78 inklusive Rastergehäuse mit 30 mm vorstehendem Stift <i>Dreh Kipp with key on rose 32x78 with TBT function and 7x30 mm spindle (mechanism included)</i>	Schwarz RAL 9005 - Matt black RAL 9005	141-T81-00E-180	1A141DKT813018XZA
	Fensterolive mit TBT Funktion Ros. 32x78 inklusive Reastergehäuse mit 35 mm vorstehendem Stift <i>Dreh Kipp with key on rose 32x78 with TBT function and 7x35 mm spindle (mechanism included)</i>	Schwarz RAL 9005 - Matt black RAL 9005	141-T81-20E-180	1A141DKT813518XZA

*Rastergehäuse finden Sie auf Seite 419 / For mechanism please see page 419

Spring Rund 141

TEKNOMETAL

Datenblatt
Datasheet



18
Schwarz RAL 9005
Matt black RAL 9005

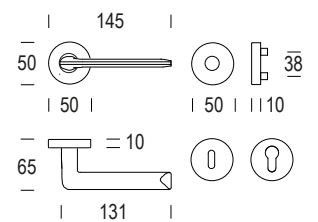

TÜRDRÜCKERGARNITUREN



141MRD17

WECHSELGARNITUREN



141PMD01

WC GARNITUREN



141RGD17

FENSTERGRIFFE



141DK015



141DK075



141DKC80







141DKT80

HEBE SCHIEBTÜRGRIFF





141MD001

Seite 432 / page 432

141MRD17	Bezeichnung - Description	Farbe - Finishes	Alte art. nr - Old code	1 Stück - Piece
	Doppelte Bezeichnung Ø50x10 mm Schlüsselloch <i>Pair lever handle on rose Ø50x10 mm key hole</i>	Schwarz RAL 9005 - Matt black RAL 9005	141-D17-031-180	1A141MRD173118ZZA
	Doppelte Bezeichnung Ø50x10 mm PZ <i>Pair lever handle on rose Ø50x10 mm euro profile cylinder hole</i>	Schwarz RAL 9005 - Matt black RAL 9005	141-D17-032-180	1A141MRD173218ZZA
	WE-Garnitur mit Knopf J01 (420) PZ beidseitig verwendbar <i>Entrance set lever handle / knob J01 (420) Euro profile cylinder hole (LH/RH)</i>	Schwarz RAL 9005 - Matt black RAL 9005	141-D17-Y01-180	1A141PMD013218YZA
	WC-Garnitur mit Rosetten Ø50x10 mm mit Riegel 512 und Schlitzschraube 8mm VK <i>Lever handle on rose Ø50x10 mm with 512 turn and release with 8 mm spindle</i>	Schwarz RAL 9005 - Matt black RAL 9005	141-D17-900-180	1A141RGD174218ZZA

FENSTERGRIFFE - WINDOW HANDLES

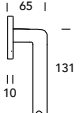
141DK015	Bezeichnung - Description	Farbe - Finishes	Alte art. nr - Old code	1 Stück - Piece
 	Fensterolive ovale Ros. 30x65 ohne Rastergehäuse (separat zu notieren*) <i>Dreh Kipp on rose without mechanism (to be ordered separately*)</i>	Schwarz RAL 9005 - Matt black RAL 9005	141-411-110-180	1A141DK0150018XZA
	Fensterolive ovale Ros. 30x65 inklusive Rastergehäuse mit 30 mm vorstehendem Stift <i>Dreh Kipp on rose and 7x30 mm spindle (mechanism included)</i>	Schwarz RAL 9005 - Matt black RAL 9005	141-411-000-180	1A141DK0153018XZA
	Fensterolive ovale Ros. 30x65 inklusive Reastergehäuse mit 35 mm vorstehendem Stift <i>Dreh Kipp on rose and 7x35 mm spindle (mechanism included)</i>	Schwarz RAL 9005 - Matt black RAL 9005	141-411-200-180	1A141DK0153518XZA

*Rastergehäuse finden Sie auf Seite 419 / For mechanism please see page 419

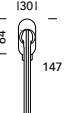
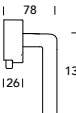
141DK075	Bezeichnung - Description	Farbe - Finishes	Alte art. nr - Old code	1 Stück - Piece
  	Fensterolive mit Druckknopf Ros. 30x64 inklusive Rastergehäuse mit 30 mm vorstehendem Stift <i>Dreh Kipp with push button on rose (mechanism included) and 7x30 mm spindle (mechanism included)</i>	Schwarz RAL 9005 - Matt black RAL 9005	141-075-030-180	1A141DK0753018XZA
	Fensterolive mit Druckknopf Ros. 30x64 inklusive Reastergehäuse mit 35 mm vorstehendem Stift <i>Dreh Kipp with push button on rose (mechanism included) and 7x35 mm spindle (mechanism included)</i>	Schwarz RAL 9005 - Matt black RAL 9005	141-075-035-180	1A141DK0753518XZA
	Fensterolive mit Druckknopf Ros. 30x64 mit 50 mm vorstehendem Stift <i>Dreh Kipp with push button on rose (mechanism included) and 7x50 mm spindle</i>	Schwarz RAL 9005 - Matt black RAL 9005	141-075-050-180	1A141DK0755018XZA

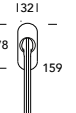
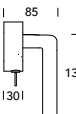
141DKC80	Bezeichnung - Description	Farbe - Finishes	Alte art. nr - Old code	1 Stück - Piece
  	Fensterolive "RC 2" zertifiziert Ros. 32x78 ohne Rastergehäuse (separat zu notieren*) <i>DK with key RC2 certified on rose 32x78 without mechanism (to be ordered separately*)</i>	Schwarz RAL 9005 - Matt black RAL 9005	141-C80-10E-180	1A141DKC800018XZA
	Fensterolive "RC 2" zertifiziert Ros. 32x78 inklusive Rastergehäuse mit 30 mm vorstehendem Stift <i>DK with key RC2 certified on rose 32x78 and 7x30 mm spindle (mechanism included)</i>	Schwarz RAL 9005 - Matt black RAL 9005	141-C80-00E-180	1A141DKC803018XZA
	Fensterolive "RC 2" zertifiziert Ros. 32x78 inklusive Reastergehäuse mit 35 mm vorstehendem Stift <i>DK with key RC2 certified on rose 32x78 and 7x35 mm spindle (mechanism included)</i>	Schwarz RAL 9005 - Matt black RAL 9005	141-C80-20E-180	1A141DKC803518XZA

*Rastergehäuse finden Sie auf Seite 419 / For mechanism please see page 419

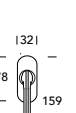
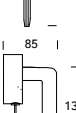
141DKT80	Bezeichnung - Description	Farbe - Finishes	Alte art. nr - Old code	1 Stück - Piece
  	Fensterolive mit TBT Funktion Ros. 32x78 ohne Rastergehäuse (separat zu notieren*) <i>Dreh Kipp with key on rose 32x78 with TBT function without mechanism (to be ordered separately*)</i>	Schwarz RAL 9005 - Matt black RAL 9005	141-T80-10E-180	1A141DKT800018XZA
	Fensterolive mit TBT Funktion Ros. 32x78 inklusive Rastergehäuse mit 30 mm vorstehendem Stift <i>Dreh Kipp with key on rose 32x78 with TBT function and 7x30 mm spindle (mechanism included)</i>	Schwarz RAL 9005 - Matt black RAL 9005	141-T80-00E-180	1A141DKT803018XZA
	Fensterolive mit TBT Funktion Ros. 32x78 inklusive Reastergehäuse mit 35 mm vorstehendem Stift <i>Dreh Kipp with key on rose 32x78 with TBT function and 7x35 mm spindle (mechanism included)</i>	Schwarz RAL 9005 - Matt black RAL 9005	141-T80-20E-180	1A141DKT803518XZA

*Rastergehäuse finden Sie auf Seite 419 / For mechanism please see page 419

Spring Minimal 141

TEKNOMETAL

Datenblatt
Datasheet



18
Schwarz RAL 9005
Matt black RAL 9005

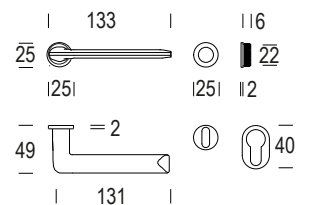

TÜRDRÜCKERGARNITUREN









141MR022

WC GARNITUREN



141RW022

141MR022	Bezeichnung - Description	Farbe - Finishes	Alte art. nr - Old code	1 Stück - Piece	
	 <p>Doppelte Bezeichnung Schlüssellochung</p> <p><i>Pair lever handle on rose key hole</i></p>	Schwarz RAL 9005 - <i>Matt black RAL 9005</i>	141-383-031-180	1A141MR0223118CZA	
	 <p>Doppelte Bezeichnung PZ</p> <p><i>Pair lever handle on rose euro profile cylinder hole</i></p>	Schwarz RAL 9005 - <i>Matt black RAL 9005</i>	141-383-032-180	1A141MR0223218CZA	
141RW022	Bezeichnung - Description	Farbe - Finishes	Alte art. nr - Old code	1 Stück - Piece	
	 <p>WC-Garnitur mit Minimal Rosetten Ø25x2 mm mit Riegel 503 und Schlitzschraube 8mm VK</p> <p><i>Lever handle on minimal rose Ø25x2 mm with 503 turn and release with 8 mm spindle</i></p>	Schwarz RAL 9005 - <i>Matt black RAL 9005</i>	141-383-900-180	1A141RW0224218BZA	









A dark, industrial scene with a black component on the left and a misty background.











JTC





EINZELTEILE
COMPONENTS

	Bezeichnung - Description	Farbe - Finishes	Alte art. nr - Old code	1 Stück - Piece
 <p>ZT - Drückerpaar mit 8mm VK Pair Handles without roses with 8mm spindle</p>		Messing Rustik - Rustic brass	90C-716-000-01M	1A900CMXXX521MCZA
		Messing Altgrau - Old silver	90C-716-000-047	1A900CMXXX5247CZA
		Messing Antik Braun - Antique	90C-716-000-0BQ	1A900CMXXX52BQCZA
 <p>Drückerlochteil rechts mit Madenschraube Right handle only with grub screw hole in lower position</p>		Messing Rustik - Rustic brass	90C-716-400-01M	1A900ID006631MCZA
		Messing Altgrau - Old silver	90C-716-400-047	1A900ID0066347CZA
		Messing Antik Braun - Antique	90C-716-400-0BQ	1A900ID00663BQCZA
 <p>Drückerlochteil links mit Madenschraube Left handle only with grub screw hole in lower position</p>		Messing Rustik - Rustic brass	90C-716-300-01M	1A900IS006631MCZA
		Messing Altgrau - Old silver	90C-716-300-047	1A900IS0066347CZA
		Messing Antik Braun - Antique	90C-716-300-0BQ	1A900IS00663BQCZA
 <p>Drückerlochteil links und rechts verwendbar mit Madenschraube intern Handle only with grub screw hole in internal position</p>		Messing Rustik - Rustic brass	90C-706-500-01M	1A900IPI06631MCZA
		Messing Altgrau - Old silver	90C-706-500-047	1A900IPI066347CZA
		Messing Antik Braun - Antique	90C-706-500-0BQ	1A900IPI0663BQCZA





Cinzia







	Bezeichnung - Description	Farbe - Finishes	Alte art. nr - Old code	1 Stück - Piece
 <p>ZT - Drückerpaar mit 8mm VK Pair Handles without roses with 8mm spindle</p>		Porz. Weiß/Messing Altgrau - White porc./Old silver	069-716-000-054	1A069CMXXX5254CZA
		Porz. Champagne/Antik Braun - Champagne porc./Antique	069-716-000-059	1A069CMXXX5259CZA
		Porz. Weiß/Antik Braun - White Porc./Antique	069-716-000-065	1A069CMXXX5265CZA
		Porz. Schwarz/Messing Altgrau - Black porc./Old silver	069-716-000-085	1A069CMXXX5285CZA
		Porz. Champagne/Messing Rustik - Champagne Porc./Rustic	069-716-000-08E	1A069CMXXX528ECZA
		Porz. Champagne/Brüniert - Porc. Champagne/Bronzed	069-716-000-08N	1A069CMXXX528NCZA
 <p>Drückerlochteil rechts mit Madenschraube Right handle only with grub screw hole in lower position</p>		Porz. Weiß/Messing Altgrau - White porc./Old silver	069-716-400-054	1A069ID0066354CZA
		Porz. Champagne/Antik Braun - Champagne porc./Antique	069-716-400-08E	1A069ID0066359CZA
		Porz. Weiß/Antik Braun - White Porc./Antique	069-716-400-065	1A069ID0066365CZA
		Porz. Schwarz/Messing Altgrau - Black porc./Old silver	069-716-400-085	1A069ID0066385CZA
		Porz. Champagne/Messing Rustik - Champagne Porc./Rustic	069-716-400-08E	1A069ID006638ECZA
		Porz. Champagne/Brüniert - Porc. Champagne/Bronzed	069-716-400-08N	1A069ID006638NCZA
 <p>Drückerlochteil links mit Madenschraube Left handle only with grub screw hole in lower position</p>		Porz. Weiß/Messing Altgrau - White porc./Old silver	069-716-300-054	1A069IS0066354CZA
		Porz. Champagne/Antik Braun - Champagne porc./Antique	069-716-300-059	1A069IS0066359CZA
		Porz. Weiß/Antik Braun - White Porc./Antique	069-716-300-065	1A069IS0066365CZA
		Porz. Schwarz/Messing Altgrau - Black porc./Old silver	069-716-300-085	1A069IS0066385CZA
		Porz. Champagne/Messing Rustik - Champagne Porc./Rustic	069-716-300-08E	1A069IS006638ECZA
		Porz. Champagne/Brüniert - Porc. Champagne/Bronzed	069-716-300-08N	1A069IS006638NCZA
 <p>Drückerlochteil links und rechts verwendbar mit Madenschraube intern Handle only with grub screw hole in internal position</p>		Porz. Weiß/Messing Altgrau - White porc./Old silver	069-706-500-054	1A069IPI066354CZA
		Porz. Champagne/Antik Braun - Champagne porc./Antique	069-706-500-059	1A069IPI066359CZA
		Porz. Weiß/Antik Braun - White Porc./Antique	069-706-500-065	1A069IPI066365CZA
		Porz. Schwarz/Messing Altgrau - Black porc./Old silver	069-706-500-085	1A069IPI066385CZA
		Porz. Champagne/Messing Rustik - Champagne Porc./Rustic	069-706-500-08E	1A069IPI06638ECZA
		Porz. Champagne/Brüniert - Porc. Champagne/Bronzed	069-706-500-08N	1A069IPI06638NCZA





	Bezeichnung - Description	Farbe - Finishes	Alte art. nr - Old code	1 Stück - Piece
	ZT - Drückerpaar mit 8mm VK <i>Pair Handles without roses with 8mm spindle</i>	Chrom - Polished chrome	101-716-000-000	1A101CMXXX5205CZA
		Ultra Messing - PVD Gold 	101-716-000-367	1A101CMXXX5246CZA
	Drückerlochteil rechts mit Madenschraube <i>Right handle only with grub screw hole in lower position</i>	Chrom - Polished chrome	101-716-400-000	1A101ID0066305CZA
		Ultra Messing - PVD Gold 	101-716-400-367	1A101ID0066346CZA
	Drückerlochteil rechts mit Madenschraube intern <i>Right handle only with grub screw hole in internal position</i>	Chrom - Polished chrome	101-706-400-000	1A101IDI066305CZA
		Ultra Messing - PVD Gold 	101-706-400-367	1A101IDI066346CZA
	Drückerlochteil links mit Madenschraube <i>Left handle only with grub screw hole in lower position</i>	Chrom - Polished chrome	101-716-300-000	1A101IS0066305CZA
		Ultra Messing - PVD Gold 	101-716-300-367	1A101IS0066346CZA
	Drückerlochteil links mit Madenschraube intern <i>Left handle only with grub screw hole in internal position</i>	Chrom - Polished chrome	101-706-300-000	1A101ISI066305CZA
		Ultra Messing - PVD Gold 	101-706-300-367	1A101ISI066346CZA

	Bezeichnung - Description	Farbe - Finishes	Alte art. nr - Old code	1 Stück - Piece
 <p>ZT - Drückerpaar mit 8mm VK <i>Pair Handles without roses with 8mm spindle</i></p>		Messing Rustik - Rustic brass	80C-716-000-01M	1A800CMXXX521MCZA
		Messing Altgrau - Old silver	80C-716-000-047	1A800CMXXX5247CZA
		Messing Brüniert 800 - Matt brushed bronzed	80C-716-000-08F	1A800CMXXX528FCZA
 <p>Drückerlochteil rechts mit Madenschraube <i>Right handle only with grub screw hole in lower position</i></p>		Messing Rustik - Rustic brass	80C-716-400-01M	1A800ID006631MCZA
		Messing Altgrau - Old silver	80C-716-400-047	1A800ID0066347CZA
		Messing Brüniert 800 - Matt brushed bronzed	80C-716-400-08F	1A800ID006638FCZA
 <p>Drückerlochteil links mit Madenschraube <i>Left handle only with grub screw hole in lower position</i></p>		Messing Rustik - Rustic brass	80C-716-300-01M	1A800IS006631MCZA
		Messing Altgrau - Old silver	80C-716-300-047	1A800IS0066347CZA
		Messing Brüniert 800 - Matt brushed bronzed	80C-716-300-08F	1A800IS006638FCZA
 <p>Drückerlochteil links und rechts verwendbar mit Madenschraube intern <i>Handle only with grub screw hole in internal position</i></p>		Messing Rustik - Rustic brass	80C-706-500-01M	1A800IPI06631MCZA
		Messing Altgrau - Old silver	80C-706-500-047	1A800IPI066347CZA
		Messing Brüniert 800 - Matt brushed bronzed	80C-706-500-08F	1A800IPI06638FCZA





Essence





	Bezeichnung - Description	Farbe - Finishes	Alte art. nr - Old code	1 Stück - Piece
 <p>ZT - Drückerpaar mit 8mm VK <i>Pair Handles without roses with 8mm spindle</i></p>		Schwarz RAL 9005 - Matt black RAL 9005	260-716-000-180	1A260CMXXX5218CZA
		Mattnickel - Satin nickel	-	1A260CMXXX5231CZA
 <p>Drückerlochteil rechts mit Madenschraube <i>Right handle only with grub screw hole in lower position</i></p>		Schwarz RAL 9005 - Matt black RAL 9005	260-716-400-180	1A260ID0066318CZA
		Mattnickel - Satin nickel	-	1A260ID0066331CZA
 <p>Drückerlochteil links mit Madenschraube <i>Left handle only with grub screw hole in lower position</i></p>		Schwarz RAL 9005 - Matt black RAL 9005	260-716-300-180	1A260IS0066318CZA
		Mattnickel - Satin nickel	-	1A260IS0066331CZA
 <p>Drückerlochteil links und rechts verwendbar mit Madenschraube intern <i>Handle only with grub screw hole in internal position</i></p>		Schwarz RAL 9005 - Matt black RAL 9005	260-706-500-180	1A260IPI066318CZA
		Mattnickel - Satin nickel	-	1A260IPI066331CZA

	Bezeichnung - Description	Farbe - Finishes	Alte art. nr - Old code	1 Stück - Piece
	ZT - Drückerpaar mit 8mm VK <i>Pair Handles without roses with 8mm spindle</i>	Messing Rustik - Rustic brass	040-716-000-01M	1A040CMXXX521MCZA
		Messing Altgrau - Old silver	040-716-000-047	1A040CMXXX5247CZA
		Messing Antik Braun - Antique	040-716-000-0BQ	1A040CMXXX52BQCZA
	Drückerlochteil rechts mit Madenschraube <i>Right handle only with grub screw hole in lower position</i>	Messing Rustik - Rustic brass	040-716-400-01M	1A040ID006631MCZA
		Messing Altgrau - Old silver	040-706-400-047	1A040ID0066347CZA
		Messing Antik Braun - Antique	040-716-400-0BQ	1A040ID00663BQCZA
	Drückerlochteil links mit Madenschraube <i>Left handle only with grub screw hole in lower position</i>	Messing Rustik - Rustic brass	040-716-300-01M	1A040IS006631MCZA
		Messing Altgrau - Old silver	040-716-300-047	1A040IS0066347CZA
		Messing Antik Braun - Antique	040-716-300-0BQ	1A040IS00663BQCZA
	Drückerlochteil links und rechts verwendbar mit Madenschraube intern <i>Handle only with grub screw hole in internal position</i>	Messing Rustik - Rustic brass	040-706-500-01M	1A040IPI06631MCZA
		Messing Altgrau - Old silver	040-706-500-047	1A040IPI066347CZA
		Messing Antik Braun - Antique	040-706-500-0BQ	1A040IPI0663BQCZA
	ZT-Halbgarnitur auf Schild 40x224 mm drehbar gelagert mit Hochhaltefeder, rechts PZ 72 mm <i>Right handle on plate 40x224 mm with Euro Profile cylinder hole 72mm</i>	Messing Rustik - Rustic brass	040-040-R13-01M	1A040PD040131MDZA
		Messing Altgrau - Old silver	040-040-R13-047	1A040PD0401347DZA
		Messing Antik Braun - Antique	040-040-R13-0BQ	1A040PD04013BQDZA
	ZT-Halbgarnitur auf Schild 40x224 mm drehbar gelagert mit Hochhaltefeder, links PZ 72 mm <i>Left handle on plate 40x224 mm with Euro Profile cylinder hole 72mm</i>	Messing Altgrau - Old silver	040-040-L13-047	1A040PS0401347DZA
		Messing Antik Braun - Antique	040-040-L13-0BQ	1A040PS04013BQDZA

	Bezeichnung - Description	Farbe - Finishes	Alte art. nr - Old code	1 Stück - Piece
 <p>ZT - Drückerpaar mit 8mm VK Pair Handles without roses with 8mm spindle</p>		Chrom - Polished chrome	004-716-000-000	1A004CMXXX5205CZA
		Schwarz RAL 9005 - Matt black RAL 9005	004-716-000-180	1A004CMXXX5218CZA
 <p>Drückerlochteil rechts mit Madenschraube Right handle only with grub screw hole in lower position</p>		Chrom - Polished chrome	004-716-400-000	1A004ID0066305CZA
		Schwarz RAL 9005 - Matt black RAL 9005	004-716-400-180	1A004ID0066318CZA
 <p>Drückerlochteil links mit Madenschraube Left handle only with grub screw hole in lower position</p>		Chrom - Polished chrome	004-716-300-000	1A004IS0066305CZA
		Schwarz RAL 9005 - Matt black RAL 9005	004-716-300-180	1A004IS0066318CZA
 <p>Drückerlochteil links und rechts verwendbar mit Madenschraube intern Handle only with grub screw hole in internal position</p>		Chrom - Polished chrome	004-706-500-000	1A004IPI066305CZA
		Schwarz RAL 9005 - Matt black RAL 9005	004-706-500-180	1A004IPI066318CZA





Ixia

	Bezeichnung - Description	Farbe - Finishes	Alte art. nr - Old code	1 Stück - Piece
 <p>ZT - Drückerpaar mit 8mm VK Pair Handles without roses with 8mm spindle</p>		Schwarz RAL 9005 - Matt black RAL 9005	J40-716-000-180	1AJ40CMXXX5218CZA
 <p>Drückerlochteil rechts mit Madenschraube Right handle only with grub screw hole in lower position</p>		Schwarz RAL 9005 - Matt black RAL 9005	J40-716-400-180	1AJ40ID0066318CZA
 <p>Drückerlochteil links mit Madenschraube Left handle only with grub screw hole in lower position</p>		Schwarz RAL 9005 - Matt black RAL 9005	J40-716-300-180	1AJ40IS0066318CZA
 <p>Drückerlochteil links und rechts verwendbar mit Madenschraube intern Handle only with grub screw hole in internal position</p>		Schwarz RAL 9005 - Matt black RAL 9005	J40-706-500-180	1AJ40IPI066318CZA





	Bezeichnung - Description	Farbe - Finishes	Alte art. nr - Old code	1 Stück - Piece
	ZT - Drückerpaar mit 8mm VK Pair Handles without roses with 8mm spindle	Chrom - Polished chrome	180-716-000-000	1A180CMXXX5205CZA
		Schwarz RAL 9005 - Matt black RAL 9005	180-716-000-180	1A180CMXXX5218CZA
		Messing Rustik - Rustic brass	180-716-000-01M	1A180CMXXX521MCZA
	Drückerlochteil rechts mit Madenschraube Right handle only with grub screw hole in lower position	Chrom - Polished chrome	180-716-400-000	1A180ID0066305CZA
		Schwarz RAL 9005 - Matt black RAL 9005	180-716-400-180	1A180ID0066318CZA
		Messing Rustik - Rustic brass	180-716-400-01M	1A180ID006631MCZA
	Drückerlochteil links mit Madenschraube Left handle only with grub screw hole in lower position	Chrom - Polished chrome	180-716-300-000	1A180IS0066305CZA
		Schwarz RAL 9005 - Matt black RAL 9005	180-716-300-180	1A180IS0066318CZA
		Messing Rustik - Rustic brass	180-716-300-01M	1A180IS006631MCZA
	Drückerlochteil links und rechts verwendbar mit Madenschraube intern Handle only with grub screw hole in internal position	Chrom - Polished chrome	180-706-500-000	1A180IPI066305CZA
		Schwarz RAL 9005 - Matt black RAL 9005	180-706-500-180	1A180IPI066318CZA
		Messing Rustik - Rustic brass	180-706-500-01M	1A180IPI06631MCZA

Linear





	Bezeichnung - Description	Farbe - Finishes	Alte art. nr - Old code	1 Stück - Piece
	ZT - Drückerpaar mit 8mm VK Pair Handles without roses with 8mm spindle	Schwarz RAL 9005 - Matt black RAL 9005	002-716-000-180	1A002CMXXX5218CZA
	Drückerlochteil rechts mit Madenschraube Right handle only with grub screw hole in lower position	Schwarz RAL 9005 - Matt black RAL 9005	002-716-400-180	1A002ID0066318CZA
	Drückerlochteil links mit Madenschraube Left handle only with grub screw hole in lower position	Schwarz RAL 9005 - Matt black RAL 9005	002-716-300-180	1A002IS0066318CZA
	Drückerlochteil links und rechts verwendbar mit Madenschraube intern Handle only with grub screw hole in internal position	Schwarz RAL 9005 - Matt black RAL 9005	002-706-500-180	1A002IPI066318CZA





	Bezeichnung - Description	Farbe - Finishes	Alte art. nr - Old code	1 Stück - Piece
 <p>ZT - Drückerpaar mit 8mm VK Pair Handles without roses with 8mm spindle</p>		Chrom - Polished chrome	-	1A001CMXXX5205CZA
		Mattnickel - Satin nickel	-	1A001CMXXX5231CZA
 <p>Drückerlochteil rechts mit Madenschraube Right handle only with grub screw hole in lower position</p>		Chrom - Polished chrome	001-716-400-000	1A001ID0066305CZA
		Mattnickel - Satin nickel	-	1A001ID0066331CZA
 <p>Drückerlochteil links mit Madenschraube Left handle only with grub screw hole in lower position</p>		Chrom - Polished chrome	001-716-300-000	1A001IS0066305CZA
		Mattnickel - Satin nickel	-	1A001IS0066331CZA
 <p>Drückerlochteil links und rechts verwendbar mit Madenschraube intern Handle only with grub screw hole in internal position</p>		Chrom - Polished chrome	001-706-500-000	1A001IPI066305CZA
		Mattnickel - Satin nickel	-	1A001IPI066331CZA

Meteor





	Bezeichnung - Description	Farbe - Finishes	Alte art. nr - Old code	1 Stück - Piece
 <p>ZT - Drückerpaar mit 8mm VK Pair Handles without roses with 8mm spindle</p>		Chrom/Edelstahl - Polished chrome/Stainless steel 304	463-116-000-035	1AJ08CMXXX52F6CZA
 <p>Drückerlochteil rechts mit Madenschraube Right handle only with grub screw hole in lower position</p>		Chrom/Edelstahl - Polished chrome/Stainless steel 304	463-716-400-035	1AJ08ID00663F6CZA
 <p>Drückerlochteil links mit Madenschraube Left handle only with grub screw hole in lower position</p>		Chrom/Edelstahl - Polished chrome/Stainless steel 304	463-716-300-035	1AJ08IS00663F6CZA
 <p>Drückerlochteil links und rechts verwendbar mit Madenschraube intern Handle only with grub screw hole in internal position</p>		Chrom/Edelstahl - Polished chrome/Stainless steel 304	463-706-500-035	1AJ08IPI0663F6CZA





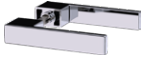

PLUS FINISH



	Bezeichnung - Description	Farbe - Finishes	Alte art. nr - Old code	1 Stück - Piece
	ZT - Drückerpaar mit 8mm VK <i>Pair Handles without roses with 8mm spindle</i>	Messing Poliert/Chrom - <i>Pol. varnished/Pol. chrome</i>	444-116-000-010	1AJ07CMXXX5226CZA
		Messing Poliert/Edelstahl - <i>Pol. varnished/Stainless steel</i>	444-116-000-036	1AJ07CMXXX525ECZA
		Chrom/Edelstahl - <i>Polished chrome/Stainless steel 304</i>	444-116-000-035	1AJ07CMXXX52F6CZA
	Drückerlochteil rechts mit Madenschraube <i>Right handle only with grub screw hole in lower position</i>	Messing Poliert/Chrom - <i>Pol. varnished/Pol. chrome</i>	444-716-400-010	1AJ07ID0066326CZA
		Messing Poliert/Edelstahl - <i>Pol. varnished/Stainless steel</i>	444-716-400-036	1AJ07ID006635ECZA
		Chrom/Edelstahl - <i>Polished chrome/Stainless steel 304</i>	444-716-400-035	1AJ07ID00663F6CZA
	Drückerlochteil links mit Madenschraube <i>Left handle only with grub screw hole in lower position</i>	Messing Poliert/Chrom - <i>Pol. varnished/Pol. chrome</i>	444-716-300-010	1AJ07IS0066326CZA
		Messing Poliert/Edelstahl - <i>Pol. varnished/Stainless steel</i>	444-716-300-036	1AJ07IS006635ECZA
		Chrom/Edelstahl - <i>Polished chrome/Stainless steel 304</i>	444-716-300-035	1AJ07IS00663F6CZA
	Drückerlochteil links und rechts verwendbar mit Madenschraube intern <i>Handle only with grub screw hole in internal position</i>	Messing Poliert/Chrom - <i>Pol. varnished/Pol. chrome</i>	444-706-500-010	1AJ07IPI066326CZA
		Messing Poliert/Edelstahl - <i>Pol. varnished/Stainless steel</i>	444-706-500-036	1AJ07IPI06635ECZA
		Chrom/Edelstahl - <i>Polished chrome/Stainless steel 304</i>	444-706-500-035	1AJ07IPI0663F6CZA

	Bezeichnung - Description	Farbe - Finishes	Alte art. nr - Old code	1 Stück - Piece
	ZT - Drückerpaar mit 8mm VK <i>Pair Handles without roses with 8mm spindle</i>	Velourschrom - Mat Silver	467-116-000-040	1AJ02CMXXX5243CZA
		Mattnickel - Satin nickel	-	1AJ02CMXXX5231CZA
	Drückerlochteil rechts mit Madenschraube <i>Right handle only with grub screw hole in lower position</i>	Velourschrom - Mat Silver	467-716-400-040	1AJ02ID0066343CZA
		Mattnickel - Satin nickel	-	1AJ02ID0066331CZA
	Drückerlochteil rechts mit Madenschraube intern <i>Right handle only with grub screw hole in internal position</i>	Velourschrom - Mat Silver	467-706-400-040	1AJ02IDI066343CZA
		Mattnickel - Satin nickel	-	1AJ02IDI066331CZA
	Drückerlochteil links mit Madenschraube <i>Left handle only with grub screw hole in lower position</i>	Velourschrom - Mat Silver	467-716-300-040	1AJ02IS0066343CZA
		Mattnickel - Satin nickel	-	1AJ02IS0066331CZA
	Drückerlochteil links mit Madenschraube intern <i>Left handle only with grub screw hole in internal position</i>	Velourschrom - Mat Silver	467-706-300-040	1AJ02ISI066343CZA
		Mattnickel - Satin nickel	-	1AJ02ISI066331CZA





Q-Arte

	Bezeichnung - Description	Farbe - Finishes	Alte art. nr - Old code	1 Stück - Piece
	ZT - Drückerpaar mit 8mm VK <i>Pair Handles without roses with 8mm spindle</i>	Chrom - Polished chrome	124-716-000-000	1A124CMXXX5205CZA
		Schwarz RAL 9005 - Matt black RAL 9005	124-716-000-180	1A124CMXXX5218CZA
		Mattnickel - Satin nickel	-	1A124CMXXX5231CZA
	Drückerlochteil rechts mit Madenschraube <i>Right handle only with grub screw hole in lower position</i>	Chrom - Polished chrome	124-716-400-000	1A124ID0066305CZA
		Schwarz RAL 9005 - Matt black RAL 9005	124-716-400-180	1A124ID0066318CZA
		Mattnickel - Satin nickel	-	1A124ID0066331CZA
	Drückerlochteil links mit Madenschraube <i>Left handle only with grub screw hole in lower position</i>	Chrom - Polished chrome	124-716-300-000	1A124IS0066305CZA
		Schwarz RAL 9005 - Matt black RAL 9005	124-716-300-180	1A124IS0066318CZA
		Mattnickel - Satin nickel	-	1A124IS0066331CZA
	Drückerlochteil links und rechts verwendbar mit Madenschraube intern <i>Handle only with grub screw hole in internal position</i>	Chrom - Polished chrome	124-706-500-000	1A124IPI066305CZA
		Schwarz RAL 9005 - Matt black RAL 9005	124-706-500-180	1A124IPI066318CZA
		Mattnickel - Satin nickel	-	1A124IPI066331CZA

	Bezeichnung - Description	Farbe - Finishes	Alte art. nr - Old code	1 Stück - Piece
	ZT - Drückerpaar mit 8mm VK <i>Pair Handles without roses with 8mm spindle</i>	Porz. Weiß/Messing Poliert - <i>White porc./Pol. varnished</i>	168-716-000-061	1A168CMXXX5261CZA
		Porz. Schwarz/Chrom - <i>Black Porc./Pol. Chrome</i>	168-716-000-0P4	1A168CMXXX52P4CZA
		Porz. Weiß/Chrom - <i>White Porc./Pol. Chrome</i>	168-716-000-0P6	1A168CMXXX52P6CZA
		Porz. Weiß/Satin Chrom - <i>White Porc./Satin Chrome</i>	168-716-000-0P7	1A168CMXXX52P7CZA
	Drückerlochteil rechts mit Madenschraube <i>Right handle only with grub screw hole in lower position</i>	Porz. Weiß/Messing Poliert - <i>White porc./Pol. varnished</i>	168-716-400-061	1A168ID0066361CZA
		Porz. Schwarz/Chrom - <i>Black Porc./Pol. Chrome</i>	168-716-400-0P4	1A168ID00663P4CZA
		Porz. Weiß/Chrom - <i>White Porc./Pol. Chrome</i>	168-716-400-0P6	1A168ID00663P6CZA
		Porz. Weiß/Satin Chrom - <i>White Porc./Satin Chrome</i>	168-716-400-0P7	1A168ID00663P7CZA
	Drückerlochteil links mit Madenschraube <i>Left handle only with grub screw hole in lower position</i>	Porz. Weiß/Messing Poliert - <i>White porc./Pol. varnished</i>	168-716-300-061	1A168IS0066361CZA
		Porz. Schwarz/Chrom - <i>Black Porc./Pol. Chrome</i>	168-716-300-0P4	1A168IS00663P4CZA
		Porz. Weiß/Chrom - <i>White Porc./Pol. Chrome</i>	168-716-300-0P6	1A168IS00663P6CZA
		Porz. Weiß/Satin Chrom - <i>White Porc./Satin Chrome</i>	168-716-300-0P7	1A168IS00663P7CZA
	Drückerlochteil links und rechts verwendbar mit Madenschraube intern <i>Handle only with grub screw hole in internal position</i>	Porz. Weiß/Messing Poliert - <i>White porc./Pol. varnished</i>	168-706-500-061	1A168IPI066361CZA
		Porz. Schwarz/Chrom - <i>Black Porc./Pol. Chrome</i>	168-706-500-0P4	1A168IPI0663P4CZA
		Porz. Weiß/Chrom - <i>White Porc./Pol. Chrome</i>	168-706-500-0P6	1A168IPI0663P6CZA
		Porz. Weiß/Satin Chrom - <i>White Porc./Satin Chrome</i>	168-706-500-0P7	1A168IPI0663P7CZA
	ZT-Halbgarnitur auf Schild 50x255 mm drehbar gelagert mit Hochhaltefeder, rechts PZ 72 mm <i>Right handle on plate 50x255 mm with Euro Profile cylinder hole 72mm</i>	Porz. Weiß/Messing Poliert - <i>White porc./Pol. varnished</i>	168-039-R13-061	1A168PD0391361DZA
		Porz. Weiß/Satin Chrom - <i>White Porc./Satin Chrome</i>	168-039-R13-0P7	1A168PD03913P7DZA
	ZT-Halbgarnitur auf Schild 50x255 mm drehbar gelagert mit Hochhaltefeder, links PZ 72 mm <i>Left handle on plate 50x255 mm with Euro Profile cylinder hole 72mm</i>	Porz. Weiß/Messing Poliert - <i>White porc./Pol. varnished</i>	168-039-L13-061	1A168PS0391361DZA
		Porz. Weiß/Satin Chrom - <i>White Porc./Satin Chrome</i>	168-039-L13-0P7	1A168PS03913P7DZA

	Bezeichnung - Description	Farbe - Finishes	Alte art. nr - Old code	1 Stück - Piece
	ZT - Drückerpaar mit 8mm VK <i>Pair Handles without roses with 8mm spindle</i>	Messing Poliert/Edelstahl - Pol. varnished/Stainless steel	462-116-000-036	1AJ06CMXXX525ECZA
		Chrom/Edelstahl - Polished chrome/Stainless steel 304	462-116-000-035	1AJ06CMXXX52F6CZA
	Drückerlochteil rechts mit Madenschraube <i>Right handle only with grub screw hole in lower position</i>	Messing Poliert/Edelstahl - Pol. varnished/Stainless steel	462-716-400-036	1AJ06ID006185ECZA
		Chrom/Edelstahl - Polished chrome/Stainless steel 304	462-716-400-035	1AJ06ID00618F6CZA
	Drückerlochteil links mit Madenschraube <i>Left handle only with grub screw hole in lower position</i>	Messing Poliert/Edelstahl - Pol. varnished/Stainless steel	462-716-300-036	1AJ06IS006185ECZA
		Chrom/Edelstahl - Polished chrome/Stainless steel 304	462-716-300-035	1AJ06IS00618F6CZA

Spring

	Bezeichnung - Description	Farbe - Finishes	Alte art. nr - Old code	1 Stück - Piece
	ZT - Drückerpaar mit 8mm VK <i>Pair Handles without roses with 8mm spindle</i>	Schwarz RAL 9005 - Matt black RAL 9005	141-716-000-180	1A141CMXXX5218CZA
	Drückerlochteil rechts mit Madenschraube <i>Right handle only with grub screw hole in lower position</i>	Schwarz RAL 9005 - Matt black RAL 9005	141-716-400-180	1A141ID0066318CZA
	Drückerlochteil links mit Madenschraube <i>Left handle only with grub screw hole in lower position</i>	Schwarz RAL 9005 - Matt black RAL 9005	141-716-300-180	1A141IS0066318CZA
	Drückerlochteil links und rechts verwendbar mit Madenschraube intern <i>Handle only with grub screw hole in internal position</i>	Schwarz RAL 9005 - Matt black RAL 9005	141-706-500-180	1A141IPI066318CZA

	Bezeichnung - Description	Farbe - Finishes	Alte art. nr - Old code	1 Stück - Piece
	Minimal Line Rosette Ø25x2 mm Minimal Line rose Ø25x2 mm	Chrom - Polished chrome	383-060-000-000	1A022ROXXXXX05XZA
		Schwarz RAL 9005 - Matt black RAL 9005	383-060-000-180	1A022ROXXXXX18XZA

022 BN

	Bezeichnung - Description	Farbe - Finishes	Alte art. nr - Old code	1 Stück - Piece
	Minimal Line BB Rosette Ø25x2 mm Minimal Line key escutcheon Ø25x2 mm	Chrom - Polished chrome	383-050-000-000	1A022BNXXXXX05XZA
		Schwarz RAL 9005 - Matt black RAL 9005	383-050-000-180	1A022BNXXXXX18XZA

022 BY

	Bezeichnung - Description	Farbe - Finishes	Alte art. nr - Old code	1 Stück - Piece
	Minimal Line PZ Rosette Ø25x2 mm Minimal Line Euro profile escutcheon 24x40x2 mm	Chrom - Polished chrome	383-050-200-000	1A022BYXXXXX05XZA
		Schwarz RAL 9005 - Matt black RAL 9005	383-050-200-180	1A022BYXXXXX18XZA

CD 17D 2M

	Bezeichnung - Description	Farbe - Finishes	Alte art. nr - Old code	1 Stück - Piece
	Paar Rosetten mit Stütznocken + Schrauben M5x50 mit Drückerlochung Pair rosettes with support cams + screws M5x50 lever handle hole	Messing Poliert - Polished varnished	D17-164-400-001	1A000CD17D2M02XZA
		Chrom - Polished chrome	D17-164-400-000	1A000CD17D2M05XZA
		Schwarz RAL 9005 - Matt black RAL 9005	D17-164-400-180	1A000CD17D2M18XZA
		Messing Rustik - Rustic brass	D17-164-400-01M	1A000CD17D2M1MXZA
		Mattnickel - Satin nickel	-	1A000CD17D2M31XZA
		Velourschrom - Mat Silver	D17-164-400-040	1A000CD17D2M43XZA
		Ultra Messing - PVD Gold	D17-164-400-367	1A000CD17D2M46XZA
		Messing Altgrau - Old silver	D17-164-400-047	1A000CD17D2M47XZA
		Messing Brüniert 800 - Matt brushed bronzed	D17-164-400-08F	1A000CD17D2M8FXZA
		Messing Antik Braun - Antique	D17-164-400-0BQ	1A000CD17D2MBQXZA

CD 17D 2B

	Bezeichnung - Description	Farbe - Finishes	Alte art. nr - Old code	1 Stück - Piece
	Paar Rosetten mit Stütznocken + Schrauben M5x50 mit BB Lochung Pair rosettes with support cams + screws M5x50 key hole	Messing Poliert - Polished varnished	D17-154-400-001	1A000CD17D2B02XZA
		Chrom - Polished chrome	D17-154-400-000	1A000CD17D2B05XZA
		Schwarz RAL 9005 - Matt black RAL 9005	D17-154-400-180	1A000CD17D2B18XZA
		Messing Rustik - Rustic brass	D17-154-400-01M	1A000CD17D2B1MXZA
		Mattnickel - Satin nickel	-	1A000CD17D2B31XZA
		Velourschrom - Mat Silver	D17-154-400-040	1A000CD17D2B43XZA
		Ultra Messing - PVD Gold	D17-154-400-367	1A000CD17D2B46XZA
		Messing Altgrau - Old silver	D17-154-400-047	1A000CD17D2B47XZA
		Messing Brüniert 800 - Matt brushed bronzed	D17-154-400-08F	1A000CD17D2B8FXZA
		Messing Antik Braun - Antique	D17-154-400-0BQ	1A000CD17D2BBQXZA

Bezeichnung - Description	Farbe - Finishes	Alte art. nr - Old code	1 Stück - Piece
 <p>Paar Rosetten mit Stütznocken + Schrauben M5x50 mit PZ Lochung</p> <p>Pair rosettes with support cams + screws M5x50 Euro profile hole</p>	Messing Poliert - Polished varnished	D17-154-500-001	1A000CD17D2Y02XZA
	Chrom - Polished chrome	D17-154-500-000	1A000CD17D2Y05XZA
	Schwarz RAL 9005 - Matt black RAL 9005	D17-154-500-180	1A000CD17D2Y18XZA
	Messing Rustik - Rustic brass	D17-154-500-01M	1A000CD17D2Y1MXZA
	Mattnickel - Satin nickel	-	1A000CD17D2Y31XZA
	Velourschrom - Mat Silver	D17-154-500-040	1A000CD17D2Y43XZA
	Ultra Messing - PVD Gold	D17-154-500-367	1A000CD17D2Y46XZA
	Messing Altgrau - Old silver	D17-154-500-047	1A000CD17D2Y47XZA
	Messing Brüniert 800 - Matt brushed bronzed	D17-154-500-08F	1A000CD17D2Y8FXZA
	Messing Antik Braun - Antique	D17-154-500-0BQ	1A000CD17D2YBQXZA

CD 17D 2C

Bezeichnung - Description	Farbe - Finishes	Alte art. nr - Old code	1 Stück - Piece
 <p>Paar Rosetten mit Stütznocken + Schrauben M5x50 ohne Loch</p> <p>Pair rosettes with support cams + screws M5x50 without key hole</p>	Messing Poliert - Polished varnished	D17-154-300-001	1A000CD17D2C02XZA
	Chrom - Polished chrome	D17-154-300-000	1A000CD17D2C05XZA
	Schwarz RAL 9005 - Matt black RAL 9005	D17-154-300-180	1A000CD17D2C18XZA
	Messing Rustik - Rustic brass	D17-154-300-01M	1A000CD17D2C1MXZA
	Mattnickel - Satin nickel	-	1A000CD17D2C31XZA
	Velourschrom - Mat Silver	D17-154-300-040	1A000CD17D2C43XZA
	Ultra Messing - PVD Gold	D17-154-300-367	1A000CD17D2C46XZA
	Messing Altgrau - Old silver	D17-154-300-047	1A000CD17D2C47XZA
	Messing Brüniert 800 - Matt brushed bronzed	D17-154-300-08F	1A000CD17D2C8FXZA
	Messing Antik Braun - Antique	D17-154-300-0BQ	1A000CD17D2CBQXZA

CD QD7 RO

Bezeichnung - Description	Farbe - Finishes	Alte art. nr - Old code	1 Stück - Piece
 <p>Paar Rosetten mit Stütznocken + Schrauben M5x50 mit Drückerlochung</p> <p>Pair rosettes with support cams + screws M5x50 lever handle hole</p>	Schwarz RAL 9005 - Matt black RAL 9005	QD7-164-400-180	1A000CDQD72M18XZA
	Mattnickel - Satin nickel	-	1A000CDQD72M31XZA

CD QD7 BN

Bezeichnung - Description	Farbe - Finishes	Alte art. nr - Old code	1 Stück - Piece
 <p>Paar Rosetten mit Stütznocken + Schrauben M5x50 mit BB Lochung</p> <p>Pair rosettes with support cams + screws M5x50 key hole</p>	Schwarz RAL 9005 - Matt black RAL 9005	QD7-154-400-180	1A000CDQD72B18XZA
	Mattnickel - Satin nickel	-	1A000CDQD72B31XZA

CD QD7 BY

Bezeichnung - Description	Farbe - Finishes	Alte art. nr - Old code	1 Stück - Piece
 <p>Paar Rosetten mit Stütznocken + Schrauben M5x50 mit PZ Lochung</p> <p>Pair rosettes with support cams + screws M5x50 Euro profile hole</p>	Schwarz RAL 9005 - Matt black RAL 9005	QD7-154-500-180	1A000CDQD72Y18XZA
	Mattnickel - Satin nickel	-	1A000CDQD72Y31XZA

	Bezeichnung - Description	Farbe - Finishes	Alte art. nr - Old code	1 Stück - Piece
	Paar Rosetten mit Stütznocken + Schrauben M5x50 ohne Loch <i>Pair rosettes with support cams + screws M5x50 without key hole</i>	Schwarz RAL 9005 - <i>Matt black RAL 9005</i>	QD7-154-300-180	1A000CDQD72C18XZA
		Mattnickel - <i>Satin nickel</i>	-	1A000CDQD72C31XZA





124 NO QD7

	Bezeichnung - Description	Farbe - Finishes	Alte art. nr - Old code	1 Stück - Piece
	WC-Rosettenpaar mit Riegel und Schlitzschraube 50x50x10 mm mit 8mm VK <i>WC turn and release on rose 50x50x10 mm with 8mm spindle</i>	Schwarz RAL 9005 - <i>Matt black RAL 9005</i>	QD7-124-900-180	1A124NOQD75218XZA
		Mattnickel - <i>Satin nickel</i>	-	1A124NOQD75231XZA

503 NO 022

	Bezeichnung - Description	Farbe - Finishes	Alte art. nr - Old code	1 Stück - Piece
	WC-Rosettenpaar mit Riegel und Schlitzschraube mit 8mm VK <i>WC turn and release with 8mm spindle</i>	Schwarz RAL 9005 - <i>Matt black RAL 9005</i>	383-503-600-180	1A503N00225218XZA
		Mattnickel - <i>Satin nickel</i>	-	1A503N00225231XZA

512 NO D17

	Bezeichnung - Description	Farbe - Finishes	Alte art. nr - Old code	1 Stück - Piece
	WC-Rosettenpaar mit Riegel und Schlitzschraube Ø50x10 mm mit 8mm VK <i>WC turn and release on rose Ø50x10 mm with 8mm spindle</i>	Messing Poliert - <i>Polished varnished</i>	D17-512-900-001	1A512NOD175202XZA
		Chrom - <i>Polished chrome</i>	D17-512-900-000	1A512NOD175205XZA
		Schwarz RAL 9005 - <i>Matt black RAL 9005</i>	D17-512-900-180	1A512NOD175218XZA
		Messing Rustik - <i>Rustic brass</i>	D17-512-900-01M	1A512NOD17521MXZA
		Mattnickel - <i>Satin nickel</i>	-	1A512NOD175231XZA
		Velourschrom - <i>Mat Silver</i>	D17-512-900-040	1A512NOD175243XZA
		Ultra Messing - <i>PVD Gold</i> 	D17-512-900-367	1A512NOD175246XZA
		Messing Altgrau - <i>Old silver</i> 	D17-512-900-047	1A512NOD175247XZA
		Messing Brüniert 800 - <i>Matt brushed bronzed</i> 	D17-512-900-08F	1A512NOD17528FXZA
Messing Antik Braun - <i>Antique</i> 	D17-512-900-0BQ	1A512NOD1752BQXZA		

016 GR

	Bezeichnung - Description	Farbe - Finishes	Alte art. nr - Old code	1 Stück - Piece
	Drückerführungsring 16mm außen 19,5 mm <i>Nylon washer 16mm with head (hole reduction from 19,5)</i>	Transparenter Kunststoff - <i>Transparent Plastic</i>	-	1A016GR195644BXXH

816 ML

	Bezeichnung - Description	Farbe - Finishes	Alte art. nr - Old code	1 Stück - Piece
	bidirektionale Hochhaltefeder mit Stütznocken <i>Bidirectional returning spring with support cams</i>	Schwarzer Kunststoff - <i>Black Plastic</i>	-	1A816MLXXXCP4CXXA

	Bezeichnung - Description	Farbe - Finishes	Alte art. nr - Old code	1 Stück - Piece
	<p>bidirektionale Hochhaltefeder mit Stütznocken</p> <p><i>Bidirectional returning spring with support cams</i></p>	<p>Schwarzer Kunststoff - Black Plastic</p>	<p>-</p>	<p>1AQ16MLXXXCP4CXXA</p>

Bezeichnung - Description	Farbe - Finishes	Alte art. nr - Old code	1 Stück - Piece
JTC Rastergehäuse für nicht abschließbare Oliven 7x30 vorstehend / 8x26 VK mit 2 Schrauben M5x40 <i>D.K. mechanism with 7x30 external / 8x26 internal spindle with 2 screws M5x40</i>	Vernickelt - Nickel Plated	000-826-737-999	1AJ21CDXXXXX3DXXX
JTC Rastergehäuse für nicht abschließbare Oliven 7x35 vorstehend / 8x26 VK mit 2 Schrauben M5x45 <i>D.K. mechanism with 7x35 external / 8x26 internal spindle with 2 screws M5x45</i>	Vernickelt - Nickel Plated	000-826-735-999	1AJ22CDXXXXX3DXXX
JTC Rastergehäuse für nicht abschließbare Oliven 7x40 vorstehend / 8x26 VK mit 2 Schrauben M5x50 <i>D.K. mechanism with 7x40 external / 8x26 internal spindle with 2 screws M5x50</i>	Vernickelt - Nickel Plated	000-826-747-999	1AJ23CDXXXXX3DXXX
JTC Rastergehäuse für nicht abschließbare Oliven 7x45 vorstehend / 8x26 VK mit 2 Schrauben M5x55 <i>D.K. mechanism with 7x45 external / 8x26 internal spindle with 2 screws M5x55</i>	Vernickelt - Nickel Plated	000-826-745-999	1AJ24CDXXXXX3DXXX
JTC Rastergehäuse für nicht abschließbare Oliven 7x50 vorstehend / 8x26 VK mit 2 Schrauben M5x60 <i>D.K. mechanism with 7x50 external / 8x26 internal spindle with 2 screws M5x60</i>	Vernickelt - Nickel Plated	000-826-757-999	1AJ25CDXXXXX3DXXX
JTC Rastergehäuse für nicht abschließbare Oliven 7x55 vorstehend / 8x26 VK mit 2 Schrauben M5x65 <i>D.K. mechanism with 7x55 external / 8x26 internal spindle with 2 screws M5x65</i>	Vernickelt - Nickel Plated	000-826-755-999	1AJ26CDXXXXX3DXXX
JTC Rastergehäuse für nicht abschließbare Oliven 7x60 vorstehend / 8x26 VK mit 2 Schrauben M5x70 <i>D.K. mechanism with 7x60 external / 8x26 internal spindle with 2 screws M5x70</i>	Vernickelt - Nickel Plated	000-826-767-999	1AJ27CDXXXXX3DXXX
JTC Rastergehäuse für nicht abschließbare Oliven 7x65 vorstehend / 8x26 VK mit 2 Schrauben M5x75 <i>D.K. mechanism with 7x65 external / 8x26 internal spindle with 2 screws M5x75</i>	Vernickelt - Nickel Plated	000-826-765-999	1AJ28CDXXXXX3DXXX
JTC Rastergehäuse für nicht abschließbare Oliven 7x70 vorstehend / 8x26 VK mit 2 Schrauben M5x80 <i>D.K. mechanism with 7x70 external / 8x26 internal spindle with 2 screws M5x80</i>	Vernickelt - Nickel Plated	000-826-777-999	1AJ29CDXXXXX3DXXX
JTC Rastergehäuse für nicht abschließbare Oliven 7x75 vorstehend / 8x26 VK mit 2 Schrauben M5x85 <i>D.K. mechanism with 7x75 external / 8x26 internal spindle with 2 screws M5x85</i>	Vernickelt - Nickel Plated	000-826-775-999	1AJ30CDXXXXX3DXXX
JTC Rastergehäuse für nicht abschließbare Oliven 7x80 vorstehend / 8x26 VK mit 2 Schrauben M5x90 <i>D.K. mechanism with 7x80 external / 8x26 internal spindle with 2 screws M5x90</i>	Vernickelt - Nickel Plated	000-826-787-999	1AJ31CDXXXXX3DXXX
JTC Rastergehäuse für nicht abschließbare Oliven 7x85 vorstehend / 8x26 VK mit 2 Schrauben M5x95 <i>D.K. mechanism with 7x85 external / 8x25 internal spindle with 2 screws M5x95</i>	Vernickelt - Nickel Plated	000-826-785-999	1AJ32CDXXXXX3DXXX







JTC

STOSSGRIFFE
PULL HANDLES

One 10NMD-CO

STOSSGRIFFE - PULL HANDLES

ALLUMINIUM

EINZELNER STOßGRIF GERADE - SINGLE STRAIGHT PULL HANDLE



NR
A-Plus Schwarz RAL 9005
Matt black RAL 9005



NO
A-Plus Satin Schwarz
Satin black



NW
A-Plus Weiß RAL 9016
Matt white RAL 9016



MONTAGESYSTEM

BEFESTIGUNGSSYSTEM EINZELN BEFESTIGUNGSSYSTEM PAARWEISE

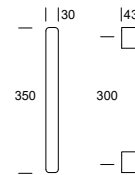
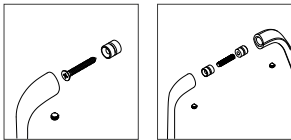

Inklusive Befestigungsmaterial für einzelne und paarweise Befestigung - Including accessories for single and back to back pull handle

10NMDXXX	Bezeichnung - Description	Farbe - Finishes	Alte art. nr - Old code	1 Stück - Piece
Stoßgriff einseitig Lochabstand mm 300 Straight pull handle C/C mm 300		A-PLUS Plus Schwarz Satiniert - Satin black	10N-300-0MD-0NO	1A10NMDXXXC0NOXZA
		Schwarz Matt RAL 9005 - Matt black RAL 9005	10N-300-0MD-0NR	1A10NMDXXXC0NRXZA
		Weiß Matt RAL 9016 - Matt white RAL 9016	10N-300-0MD-0NW	1A10NMDXXXC0NWXZA

One 10NMD-FO

STOSSGRIFFE - PULL HANDLES

ALLUMINIUM

EINZELNER STOßGRIF GERADE - SINGLE STRAIGHT PULL HANDLE



NR
A-Plus Schwarz RAL 9005
Matt black RAL 9005



NO
A-Plus Satin Schwarz
Satin black



NW
A-Plus Weiß RAL 9016
Matt white RAL 9016



MONTAGESYSTEM

BEFESTIGUNGSSYSTEM EINZELN BEFESTIGUNGSSYSTEM PAARWEISE

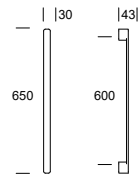
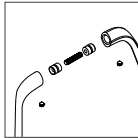
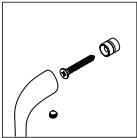

Inklusive Befestigungsmaterial für einzelne und paarweise Befestigung - Including accessories for single and back to back pull handle

10NMDXXX	Bezeichnung - Description	Farbe - Finishes	Alte art. nr - Old code	1 Stück - Piece
	Stoßgriff einseitig Lochabstand mm 600 Straight pull handle C/C mm 600	A-PLUS Plus Schwarz Satiniert - Satin black	10N-600-0MD-0NO	1A10NMDXXXF0NOXZA
		Schwarz Matt RAL 9005 - Matt black RAL 9005	10N-600-0MD-0NR	1A10NMDXXXF0NRXZA
		Weiß Matt RAL 9016 - Matt white RAL 9016	10N-600-0MD-0NW	1A10NMDXXXF0NWXZA





JTC

SCHIEBETÜRBESCHLÄGE
HEBE
LIFT AND SLIDE PULL
HANDLES



1M
Messing Rustik
Rustic brass



47
Messing Altgrau
Old silver



BQ
Messing Antik Braun
Antique brass

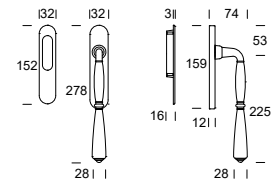

307HS31369











307HS31300



307HD31369



313PI002

307MD000	Bezeichnung - Description	Farbe - Finishes	Alte art. nr - Old code	1 Stück - Piece
	Hebe- / Schiebetürgriff auf Schild PZ (euro profile cylinder key hole) Single pull handle for lift and slide, with euro profile cylinder plate without flush pull plate	Messing Antik Braun - Antique	-	1A307HS31369BQXZA
		Messing Altgrau - Old silver 	-	1A307HS3136947XZA
		Messing Rustik - Rustic brass 	-	1A307HS313691MXZA
	Hebe- / Schiebetürgriff auf Schild ohne Loch Single pull handle for lift and slide, blind without flush pull plate	Messing Antik Braun - Antique	-	1A307HS31300BQXZA
		Messing Altgrau - Old silver 	-	1A307HS3130047XZA
		Messing Rustik - Rustic brass 	-	1A307HS313001MXZA
	Hebe- / Schiebetürgriff Set PZ Paar Hebe- / Schiebetürgriffe auf Schild PZ Pair pull handles for lift and slide with Euro profile hole	Messing Antik Braun - Antique	-	1A307HD31369BQXZA
		Messing Altgrau - Old silver 	-	1A307HD3136947XZA
		Messing Rustik - Rustic brass 	-	1A307HD313691MXZA
	Schiebetürmuschel ohne Loch Flush pull plate for lift and slide pull handle without key hole	Messing Antik Braun - Antique	-	1A313PI002XXBQXJA
		Messing Altgrau - Old silver 	-	1A313PI002XX47XJA
		Messing Rustik - Rustic brass 	-	1A313PI002XX1MXJA



05
Chrom
Polished chrome



18
Schwarz RAL 9005
Matt black RAL 9005



31
Mattnickel
Satin nickel

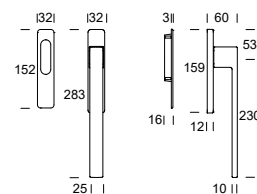

124HSQ1369







124HSQ1300



124HDQ1369



Q13PI002

124HSQ13	Bezeichnung - Description	Farbe - Finishes	Alte art. nr - Old code	1 Stück - Piece
	Hebe-/ Schiebetürgriff auf Schild PZ (euro profile cylinder key hole) Single pull handle for lift and slide, with euro profile cylinder plate without flush pull plate	Chrom - Polished chrome	-	1A124HSQ136905XZA
		Schwarz RAL 9005 - Matt black RAL 9005	-	1A124HSQ136918XZA
		Mattnickel - Satin nickel	-	1A124HSQ136931XZA
	Hebe-/ Schiebetürgriff auf Schild ohne Loch Single pull handle for lift and slide, blind without flush pull plate	Chrom - Polished chrome	-	1A124HSQ130005XZA
		Schwarz RAL 9005 - Matt black RAL 9005	-	1A124HSQ130018XZA
		Mattnickel - Satin nickel	-	1A124HSQ130031XZA
	Hebe-/ Schiebetürgriff Set PZ Paar Hebe-/ Schiebetürgriffe auf Schild PZ Pair pull handles for lift and slide with Euro profile hole	Chrom - Polished chrome	-	1A124HDQ136905XZA
		Schwarz RAL 9005 - Matt black RAL 9005	-	1A124HDQ136918XZA
		Mattnickel - Satin nickel	-	1A124HDQ136931XZA
	Schiebtürmuschel ohne Loch Flush pull plate for lift and slide pull handle without key hole	Chrom - Polished chrome	-	1AQ13PI002XX05XJA
		Schwarz RAL 9005 - Matt black RAL 9005	-	1AQ13PI002XX18XJA
		Mattnickel - Satin nickel	-	1AQ13PI002XX31XJA

Spring Eckig 141

HEBE SCHIEBETÜR BESCHLÄGE
PULL HANDLES FOR LIFT AND SLIDING DOORS



18
Schwarz RAL 9005
Matt black RAL 9005

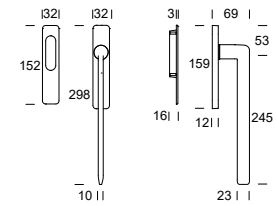

141HSQ1369



141HSQ1300



141HDQ1369



Q13PI002

141HSQ13	Bezeichnung - Description	Farbe - Finishes	Alte art. nr - Old code	1 Stück - Piece
	<p>Hebe- / Schiebetürgriff auf Schild PZ (euro profile cylinder key hole)</p> <p>Single pull handle for lift and slide, with euro profile cylinder plate without flush pull plate</p>	<p>Schwarz RAL 9005 - Matt black RAL 9005</p>	<p>-</p>	<p>1A141HSQ136918XZA</p>
	<p>Hebe- / Schiebetürgriff auf Schild ohne Loch</p> <p>Single pull handle for lift and slide, blind without flush pull plate</p>	<p>Schwarz RAL 9005 - Matt black RAL 9005</p>	<p>-</p>	<p>1A141HSQ130018XZA</p>
	<p>Hebe- / Schiebetürgriff Set PZ Paar Hebe- / Schiebetürgriffe auf Schild PZ</p> <p>Pair pull handles for lift and slide with Euro profile hole</p>	<p>Schwarz RAL 9005 - Matt black RAL 9005</p>	<p>-</p>	<p>1A141HDQ136918XZA</p>
	<p>Schiebetürmuschel ohne Loch</p> <p>Flush pull plate for lift and slide pull handle without key hole</p>	<p>Schwarz RAL 9005 - Matt black RAL 9005</p>	<p>-</p>	<p>1AQ13PI002XX18XJA</p>

Spring Rund 141

HEBE SCHIEBETÜR BESCHLÄGE
PULL HANDLES FOR LIFT AND SLIDING DOORS



18
Schwarz RAL9005
Matt black RAL9005

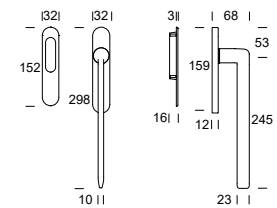

141HS31369





141HS31300





141HD31369





313PI002



141HS313	Bezeichnung - Description	Farbe - Finishes	Alte art. nr - Old code	1 Stück - Piece
	<p>Hebe- / Schiebetürgriff auf Schild PZ (euro profile cylinder key hole)</p> <p><i>Single pull handle for lift and slide, with euro profile cylinder plate without flush pull plate</i></p>	<p>Schwarz RAL 9005 - <i>Matt black RAL 9005</i></p>	<p>-</p>	<p>1A141HS3136918XZA</p>
	<p>Hebe- / Schiebetürgriff auf Schild ohne Loch</p> <p><i>Single pull handle for lift and slide, blind without flush pull plate</i></p>	<p>Schwarz RAL 9005 - <i>Matt black RAL 9005</i></p>	<p>-</p>	<p>1A141HS3130018XZA</p>
	<p>Hebe- / Schiebetürgriff Set PZ Paar Hebe- / Schiebetürgriffe auf Schild PZ</p> <p><i>Pair pull handles for lift and slide with Euro profile hole</i></p>	<p>Schwarz RAL 9005 - <i>Matt black RAL 9005</i></p>	<p>-</p>	<p>1A141HD3136918XZA</p>
	<p>Schiebetürmuschel ohne Loch</p> <p><i>Flush pull plate for lift and slide pull handle without key hole</i></p>	<p>Schwarz RAL 9005 - <i>Matt black RAL 9005</i></p>	<p>-</p>	<p>1A313PI002XX18XJA</p>

	Bezeichnung - Description	Farbe - Finishes	Alte art. nr - Old code	1 Stück - Piece
	Schiebtürmuschel ohne Loch Flush pull plate without key hole	Chrom - Polished chrome	964-125-000-000	1AJ01PI002XX05XZA
	Schiebtürmuschel BB Flush pull plate key hole	Chrom - Polished chrome	964-125-100-000	1AJ01PI001XX05XZA

JO2 PI

	Bezeichnung - Description	Farbe - Finishes	Alte art. nr - Old code	1 Stück - Piece
	Schiebtürmuschel ohne Loch Flush pull plate without key hole	Messing Poliert - Polished varnished	342-125-000-001	1AJ02PI002XX02XZA
		Chrom - Polished chrome	342-125-000-000	1AJ02PI002XX05XZA
		Edelstahl - Stainless steel 304	342-125-000-055	1AJ02PI002XX5SXZA
	Schiebtürmuschel BB Flush pull plate key hole	Messing Poliert - Polished varnished	342-125-100-001	1AJ02PI001XX02XZA
		Chrom - Polished chrome	342-125-100-000	1AJ02PI001XX05XZA
		Edelstahl - Stainless steel 304	342-125-100-055	1AJ02PI001XX5SXZA

JO3 PI

	Bezeichnung - Description	Farbe - Finishes	Alte art. nr - Old code	1 Stück - Piece
	Schiebtürmuschel ohne Loch Flush pull plate without key hole	Messing Poliert - Polished varnished	940-000-000-001	1AJ03PI002XX02XZA
		Chrom - Polished chrome	940-000-000-000	1AJ03PI002XX05XZA
	Schiebtürmuschel BB Flush pull plate key hole	Messing Poliert - Polished varnished	940-000-100-001	1AJ03PI001XX02XZA
		Chrom - Polished chrome	940-000-100-000	1AJ03PI001XX05XZA
	Schiebtürmuschel PZ Flush pull plate Euro profile cylinder hole	Messing Poliert - Polished varnished	940-000-200-001	1AJ03PI011XX02XZA
		Chrom - Polished chrome	940-000-200-000	1AJ03PI011XX05XZA





JTC

**GANZGLASTÜRBE
SCHLÄGE**
GLASS DOORS



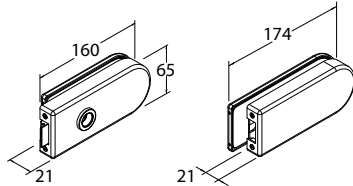

5S
Edelstahl
Stainless steel 304



R51SR



R52SR



R53SR

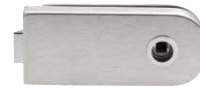

R54SR







R51IN



Einstellbare Drückeralagefunktion ± 3 Grad
Adjustable handle function ± 3 degree



Einstellbare Funktion für die Federvorspannung
Spring force adjustable function

R51SRXXX	Bezeichnung - Description	Farbe - Finishes	Alte art. nr - Old code	1 Stück - Piece
	Glastürschloss Drücker vorn, blind, ohne Drücker, mit Klemmnuss, ohne Drücker, mit Klemmnuss, Edelstahl/Aluminium Abdeckung Abdeckung Abdeckung Lock lever front, without keyhole for glass doors, without lever, with clamp follower, stainless steel/aluminium cover cover	Edelstahl - Stainless steel 304	409-018-300-055	1AR51SRXXXXX5SXXA
	Glastürschloss BB gelocht, ohne Drücker, mit Klemmnuss, Edelstahl/Aluminium Abdeckung Abdeckung Lock with standard lever keyhole for glass doors, without lever, with clamp follower, stainless steel/aluminium cover cover	Edelstahl - Stainless steel 304	409-018-100-055	1AR52SRXXXXX5SXXA
	Glastürschloss PZ gelocht, ohne Drücker, mit Klemmnuss, ohne Drücker, mit Klemmnuss, Edelstahl/Aluminium Abdeckung Abdeckung Abdeckung Lock only with euro profile cylinder keyhole without lever, with clamp follower, stainless steel/aluminium cover cover	Edelstahl - Stainless steel 304	409-018-200-055	1AR53SRXXXXX5SXXA
	Glastürschloss Drücker hinten, blind, ohne Drücker, mit Klemmnuss, ohne Drücker, mit Klemmnuss, Edelstahl/Aluminium Abdeckung Abdeckung Abdeckung Lock lever back without keyhole for glass doors, without lever, with clamp follower, stainless steel/aluminium cover cover	Edelstahl - Stainless steel 304	409-018-400-055	1AR54SRXXXXX5SXXA
	Schlossgegenkasten Striker for double glass doors	Edelstahl - Stainless steel 304	409-008-000-055	1AR51INXXXXX5SXXA

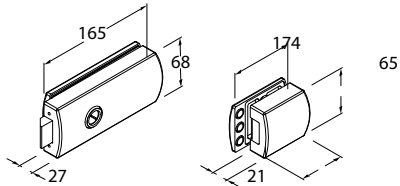

5S
Edelstahl
Stainless steel 304



R41SR



R42SR



R43SR



R44SR







R41IN



Einstellbare Drückerlagefunktion ± 3 Grad
Adjustable handle function ± 3 degree



Einstellbare Funktion für die Federvorspannung
Spring force adjustable function

R41SRXXX	Bezeichnung - Description	Farbe - Finishes	Alte art. nr - Old code	1 Stück - Piece
	Glastürschloss Drücker vorn, blind, ohne Drücker, mit Klemmnuss, Edelstahl Abdeckung Lock lever front, without keyhole for glass doors, without lever, with clamp follower, stainless steel cover	Edelstahl - Stainless steel 304	409-518-300-055	1AR41SRXXXXX5SXXA
	Glastürschloss BB gelocht, ohne Drücker, mit Klemmnuss, Edelstahl Abdeckung Lock with standard lever keyhole for glass doors, without lever, with clamp follower, stainless steel cover	Edelstahl - Stainless steel 304	409-518-100-055	1AR42SRXXXXX5SXXA
	Glastürschloss BB gelocht, ohne Drücker, mit Klemmnuss, Edelstahl Abdeckung Lock only with euro profile cylinder keyhole, without lever, with clamp follower, stainless steel cover	Edelstahl - Stainless steel 304	409-518-200-055	1AR43SRXXXXX5SXXA
	Glastürschloss Drücker hinten, blind, ohne Drücker, mit Klemmnuss, Edelstahl Abdeckung Lock lever back, without keyhole for glass doors, without lever, with clamp follower, stainless steel cover	Edelstahl - Stainless steel 304	409-518-400-055	1AR44SRXXXXX5SXXA
	Schlossgegenkasten Striker for double glass doors	Edelstahl - Stainless steel 304	409-508-000-055	1AR41INXXXXX5SXXA



05
Chrom
Polished chrome



31
Mattnickel
Satin nickel

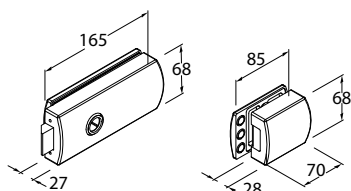

R21SR



R22SR





R23SR



Einstellbare Drückeralagefunktion ± 3 Grad
Adjustable handle function ± 3 degree



Einstellbare Funktion für die Federvorspannung
Spring force adjustable function

R21SRXXX	Bezeichnung - Description	Farbe - Finishes	Alte art. nr - Old code	1 Stück - Piece
	Glastürschloss Drücker vorn, blind, ohne Drücker, mit Klemmnuss Lock lever front, without keyhole for glass doors, without lever, with clamp follower	Chrom - Polished chrome	409-318-300-000	1AR21SRXXXX05XXA
		Mattnickel - Satin nickel	-	1AR21SRXXXX31XXA
	Glastürschloss BB gelocht, ohne Drücker, mit Klemmnuss Lock with standard lever keyhole for glass doors, without lever, with clamp follower	Chrom - Polished chrome	409-318-100-000	1AR22SRXXXX05XXA
		Mattnickel - Satin nickel	-	1AR22SRXXXX31XXA
	Glastürschloss PZ gelocht, ohne Drücker, mit Klemmnuss Lock only with euro profile cylinder keyhole, without lever, with clamp follower	Chrom - Polished chrome	409-318-200-000	1AR23SRXXXX05XXA
		Mattnickel - Satin nickel	-	1AR23SRXXXX31XXA

Compact Square

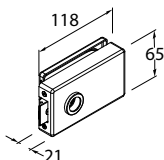

5S
Edelstahl
Stainless steel 304



C41SR



C43SR



Einstellbare Funktion für die Federvorspannung
Spring force adjustable function

C41SRXXX	Bezeichnung - Description	Farbe - Finishes	Alte art. nr - Old code	1 Stück - Piece
	Glasturschloss Drücker vorn, blind, ohne Drücker, mit Klemmnuss, Edelstahl Abdeckung <i>Lock lever front, without keyhole, without lever, with clamp follower, stainless steel cover</i>	Edelstahl - Stainless steel 304	400-018-303-055	1AC41SRXXXXX5SXXA
	Glasturschloss PZ, ohne Drücker, mit Klemmnuss, Edelstahl Abdeckung <i>Lock only with euro profile cylinder keyhole without lever, with clamp follower, stainless steel cover</i>	Edelstahl - Stainless steel 304	400-018-200-055	1AC43SRXXXXX5SXXA

493 CE P39

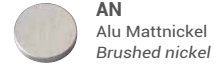
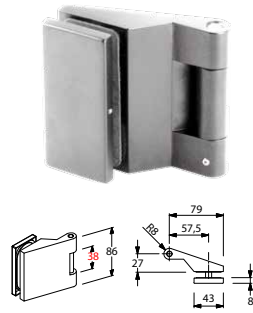

AN
Alu Mattnickel
Brushed nickel

493CEP39	Bezeichnung - Description	Farbe - Finishes	Alte art. nr - Old code	1 Stück - Piece
	Bänderpaar dreiteilig mit Hülsen ohne Rahmenteil, Material Aluminium, Gegenplatte 39mm <i>Pair of hinges (three-part) including decorative sleeves (without frame pivot), aluminium, with front plate 39mm</i>	Mattnickel - Brushed Nickel	408-039-000-044	1A493CEP39XXANXXA

592 CE

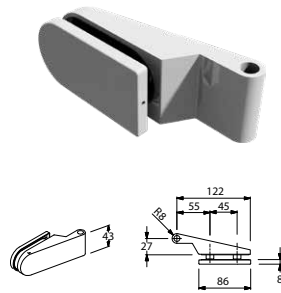
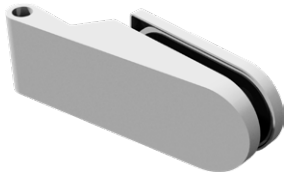

AN
Alu Mattnickel
Brushed nickel

592CEXXX	Bezeichnung - Description	Farbe - Finishes	Alte art. nr - Old code	1 Stück - Piece
	Bänderpaar zweiteilig mit 2 Hülsen ohne Rahmenteil, Material Aluminium <i>Pair of hinges (two-part) including decorative sleeves (without frame pivot), aluminium</i>	Mattnickel - Brushed Nickel	409-002-000-044	1A592CEXXXXANXXA





JTC

MÖBELBESCHLÄGE
FURNITURE HARDWARE



122 PN



-  **02**
Messing Poliert
Polished varnished
-  **05**
Chrom
Polished chrome

122PN025	Bezeichnung - Description	Farbe - Finishes	Alte art. nr - Old code	1 Stück - Piece
		Messing Poliert - Polished varnished	611-025-000-001	1A122PN025XX02XZL
		Chrom - Polished chrome	611-025-000-000	1A122PN025XX05XZL

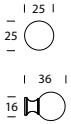

Möbel Knopf mm 25
Small knob mm 25

J05 PN



-  **05**
Chrom
Polished chrome
-  **31**
Mattnickel
Satin nickel

J05PN025	Bezeichnung - Description	Farbe - Finishes	Alte art. nr - Old code	1 Stück - Piece
		Chrom - Polished chrome	125-025-000-000	1AJ05PN025XX05XXI
		Mattnickel - Satin nickel	125-025-000-044	1AJ05PN025XX31XXI

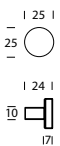

Möbel Knopf mm 25
Small knob mm 25

J07 PN



J07PN025	Bezeichnung - Description	Farbe - Finishes	Alte art. nr - Old code	1 Stück - Piece
<p>Möbel Knopf mm 25 Small knob mm 25</p>		Messing Poliert - Polished varnished	265-025-000-001	1AJ07PN025XX02XXI
<p>Möbel Knopf mm 32 Small knob mm 32</p>		Messing Poliert - Polished varnished	265-032-000-001	1AJ07PN032XX02XXI

J08 PN



J08PN030	Bezeichnung - Description	Farbe - Finishes	Alte art. nr - Old code	1 Stück - Piece
<p>Möbel Knopf mm 30 Small knob mm 30</p>		Messing Poliert - Polished varnished	266-030-000-001	1AJ08PN030XX02XXI

536 PI



536PI002

Bezeichnung - Description

Farbe - Finishes

Alte art. nr - Old code

1 Stück - Piece

Nickel Poliert - Polished nickel

286-040-000-004

1A536PI002XX09XXI

Einlassgriff für Glasschieber Ø 43 mm Bohrmaß 37mm, Einlasstiefe 11,5mm ohne Loch

Countersink handle for glass slide Ø 43 mm, bore dimension 37mm, countersink depth 11,5 mm without key hole

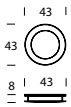

J08 PI

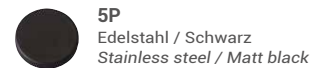

J08PI002

Bezeichnung - Description

Farbe - Finishes

Alte art. nr - Old code

1 Stück - Piece

Schwarz RAL 9005 - Matt black RAL 9005

318-050-000-022

1AJ08PI002XX18XXI

Edelstahl / Schwarz - Satin Stainless Steel / Matt Black

318-050-000-285

1AJ08PI002XX5PXXI

Einlassmuschelgriff 47x47mm Bohrmaß Ø 38mm, Einlasstiefe 11,5mm ohne Loch

Countersink shell handle 47x47mm, bore dimension Ø 38mm, countersink depth 11,5 mm without key hole

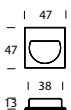

J10 PI



5P

Edelstahl / Schwarz
Satin stainless steel / Matt black

J10PI002	Bezeichnung - Description	Farbe - Finishes	Alte art. nr - Old code	1 Stück - Piece
		Edelstahl / Schwarz - Satin Stainless Steel / Matt Black	320-045-000-285	1AJ10PI002XX5PXXI

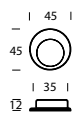

Einlassmuschelgriff Ø 45mm
Bohrmaß Ø 35mm, Einlasstiefe
11,5mm ohne Loch

Countersink shell handle Ø
45mm, bore dimension Ø 35mm,
countersink depth 11,5 mm
without key hole

J12 PI



5P

Edelstahl / Schwarz
Satin stainless steel / Matt black

J12PI002	Bezeichnung - Description	Farbe - Finishes	Alte art. nr - Old code	1 Stück - Piece
		Edelstahl / Schwarz - Satin Stainless Steel / Matt Black	324-085-000-285	1AJ12PI002XX5PXXI

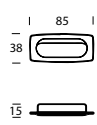

Einlassmuschelgriff 85x38mm
Bohrmaß 71x29mm, Einlasstiefe
11,5mm ohne Loch

Countersink shell handle
85x38mm, bore dimension
71x29mm, countersink depth 11,5
mm without key hole



J71 BN



J71BNXXX	Bezeichnung - Description	Farbe - Finishes	Alte art. nr - Old code	1 Stück - Piece
	 <p>Möbelschild Ø30x9mm Key escutcheon Ø30x9mm</p>	Mattnickel - Satin nickel	054-013-000-044	1AJ71BNXXXXX31XXI



J73 BN

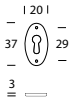



J73BNXXX	Bezeichnung - Description	Farbe - Finishes	Alte art. nr - Old code	1 Stück - Piece
	 <p>Möbelschild oval 37x20mm Key escutcheon 37x20mm</p>	Messing Poliert - Polished varnished	070-037-000-001	1AJ73BNXXXXX02XXI
		Nickel spiegelpol. Plus - Pol. Nickel Plus	070-037-000-004	1AJ73BNXXXXXK1XXI

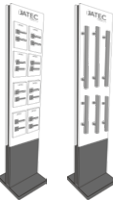

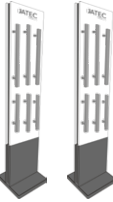
BESCHLAGDISPLAY
DISPLAY BOARDS

ZT01ES0L8	Descrizione - Description	1 Pezzo - Piece
	<p>LÖSUNG A - SOLUTION A</p> <p>2-seitig drehbare Schautafel 180x45 cm - 1. Seite: 8 Paneele 20x30 2. Seite: Ziehgriffe (Muster auf Anfrage inklusive)</p> <p><i>2-sided rotating display board 180x45 cm - 1st side: 8 panels 20x30 2nd side: pull handles (Sample on request included)</i></p>	UZT01ES0L8XXBNLXA
ZT01ES016	Descrizione - Description	1 Pezzo - Piece
	<p>LÖSUNG B - SOLUTION B</p> <p>2-seitig drehbare Schautafel 180x45 cm - 1. Seite: 8 Tafeln 20x30 2. Seite: 8 Tafeln 20x30 (Muster auf Anfrage inklusive)</p> <p><i>2-sided rotating display board 180x45 cm - 1st side: 8 panels 20x30 2nd side: 8 panels 20x30 (Sample on request included)</i></p>	UZT01ES016XXBNLXA
ZT01ES0SP	Descrizione - Description	1 Pezzo - Piece
	<p>LÖSUNG C - SOLUTION C</p> <p>2-seitig drehbare Schautafel 180x45 cm - 1. Seite: Ziehgriffe 2. Seite: Ziehgriffe (Muster auf Anfrage inklusive)</p> <p><i>2-sided rotating display board 180x45 cm - 1st side: pull handles 2nd side: pull handles (Sample on request included)</i></p>	UZT01ES0SPXXBNLXA

ZOORES

Z00RES021	Descrizione - Description	1 Pezzo - Piece
	<p>Einzelne tafeln cm 22x30 (Muster auf Anfrage inklusive)</p> <p><i>Single panel 22 x 30 cm (Sample on request included)</i></p>	UZ00RES021196ZXXX
Z00RES022	Descrizione - Description	1 Pezzo - Piece
	<p>Einzelne tafeln cm 50x30 (Muster auf Anfrage inklusive)</p> <p><i>Single panel 50 x 30 cm (Sample on request included)</i></p>	UZ00RES022196ZXXX
Z00RES065	Descrizione - Description	1 Pezzo - Piece
	<p>Einzelne tafeln cm 22x65 (Muster auf Anfrage inklusive)</p> <p><i>Single panel 22 x 65 cm (Sample on request included)</i></p>	UZ00RES06596ZXXX

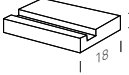
ZBPSES024	Descrizione - Description	1 Pezzo - Piece
	Sockel für einzelne Platten <i>Base for single panels</i>	UZBPSES024XXXXXXX

ZOOOES

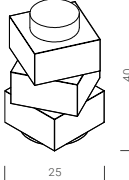
Z000ESB12	Descrizione - Description	1 Pezzo - Piece
	Drehbares theken-display mit 12 Türgriffe (Muster auf Anfrage inklusive) <i>Rotating table display board - Application n. 12 horizontal door handle (Sample on request included)</i>	UZ00RESB12056GXXX

ZOORES

Z00RES100	Descrizione - Description	1 Pezzo - Piece
	Wandpanel cm 60x100 mit magnetischen System (Muster auf Anfrage inklusive) <i>Magnetic wall display boards 60x100 cm (Sample on request included)</i>	UZ00RES100196ZWXX

Z00RES140	Descrizione - Description	1 Pezzo - Piece
	Wandpanel cm 60x140 mit magnetischen System (Muster auf Anfrage inklusive) <i>Magnetic wall display boards 60x140 cm (Sample on request included)</i>	UZ00RES140196ZWXX

Z00RES240	Descrizione - Description	1 Pezzo - Piece
	Wandpanel cm 60x240 mit magnetischen System (Muster auf Anfrage inklusive) <i>Magnetic wall display boards 60x240 cm (Sample on request included)</i>	UZ00RES240196ZWXX

Z00RES000	Descrizione - Description	1 Pezzo - Piece
	Einzelne tafeln cm 50x110 (Muster auf Anfrage inklusive) <i>Wall display boards 50x110 cm (Sample on request included)</i>	UZ00RES003196ZXXX

TECHNISCHE INFORMATIONEN

TECHNICAL INFO

INDICE INDEX

SYMBOLS	458
ZERTIFIZIERUNG	459
ZERTIFIZIERUNG - TÜRGRIFFEN JA-TEC SYSTEM	460
ZERTIFIZIERUNG - TÜRGRIFFEN SM SYSTEM	460
ZERTIFIZIERUNG - TÜRGRIFFEN R1 SYSTEM	461
ZERTIFIZIERUNG - TÜRGRIFFEN R16 SYSTEM	461
ZERTIFIZIERUNG - FEUERSCHUTZ	462
ZERTIFIZIERUNG - SCHUTZGARNITUREN	463
ZERTIFIZIERUNG - FENSTERBESCHLÄGE 4 POSITIONEN	467
ZERTIFIZIERUNG - FENSTERBESCHLÄGE SECURBLOCK	469
ZERTIFIZIERUNG - FENSTERBESCHLÄGE SECURKEY	470
ZERTIFIZIERUNG - FENSTERBESCHLÄGE RC2 ZERTIFIZIERT	471
ZERTIFIZIERUNG - FENSTERBESCHLÄGE TBT FUNKTION	472
MONTAGEANLEITUNG	473
MONTAGEANLEITUNG - TÜRGRIFFEN JA-TEC SYSTEM	473
MONTAGEANLEITUNG - TÜRGRIFFEN SM SYSTEM	476
MONTAGEANLEITUNG - TÜRGRIFFEN FLÄCHBÜNDIGE ROSETTE	478

MONTAGEANLEITUNG - TÜRGRIFFEN SLIM ROSETTE MOUNTING INSTRUCTIONS - DOOR HANDLES SLIM ROSE	480
MONTAGEANLEITUNG - FEUERSCHUTZ MOUNTING INSTRUCTIONS - FIRE PROOF	481
MONTAGEANLEITUNG - SCHUTZGARNITUREN MOUNTING INSTRUCTIONS - SECURITY SETS	483
MONTAGEANLEITUNG - KNÖPFE MOUNTING INSTRUCTIONS - KNOBS	487
MONTAGEANLEITUNG - HEBE SCHIEBETÜRBESCHLÄGE MOUNTING INSTRUCTIONS - PULL HANDLES FOR LIFT AND SLIDING DOORS	488
MONTAGEANLEITUNG - STOßGRIFFE MOUNTING INSTRUCTIONS - PULL HANDLES	490
MONTAGEANLEITUNG - GANZGLASTÜRBESCHLÄGE MOUNTING INSTRUCTIONS - GLASS DOORS	492

SIMBOLI SYMBOLS

INFORMATIONEN ZU DEN OBERFLÄCHEN FINISHES INFO



Messing
Brass



Teknometal
Teknomatal



Aluminium
Aluminium



Edelstahl
Stainless steel



Porzellan
Porcelain



PVD Ultra Beschichtung
PVD Ultra finish



Plus Beschichtung
Plus finish



Antigerm
Antigerm

ROSEN ROSES



Minimal Rose mit Feder
Minimal Rose with spring

ANWENDUNGSSYSTEM APPLICATION SYSTEM



Ja-tec system
Ja-tec system



R16 system
R16 system



R1 system
R1 system



TS 38-45 mm
TS 38-45 mm



SM system
SM system



DK system
DK system



4 Positionen system
4 position system



TBT system
TBT system



Securkey
Securkey



Securblock
Securblock



Securkey RC2 resistenz
Securkey RC2 resistance



SKG Zertifikat
SKG Certificate

ZERTIFIZIERUNGE

CERTIFICATIONS

DIN EN 1906 - Europäische und nationale Normung für Beschläge. Die DIN EN 1906 wurde mit dem Zweck der Europäischen Standardisierung eingeführt, um Anforderungen und Prüfverfahren für Türgriffe und -knöpfe zu spezifizieren. Innerhalb von Europa ist sie seit Oktober 2001 gültig. Im Rahmen der europäischen Normungsarbeit wurde die EN 1906 formuliert, die die Anforderungen und Prüfverfahren für Türgriffe und Türknöpfe definiert. Diese Europäische Norm legt Prüfverfahren und Anforderungen an Stiften und Befestigungselementen, Betriebsmomenten, zulässigem freien Spiel und Sicherheit, freier Winkelbewegung und Justierbeständigkeit, statischer Festigkeit und Korrosionsbeständigkeit für gefederte und ungedederte Griffe und Knöpfe für Türen auf Schildern und Rosetten fest.

DIN EN 1906 –European and national standardisation for hardware. For the purposes of European standardisation the DIN EN 1906 has been introduced to specify requirements and test methods for door handles and door knobs. It became valid throughout Europe in October 2001 and has been included step-by-step into national regulations. The DIN EN 1906 defines only performance parameters (hardware dimensions have not been taken into account). It introduces a classification code system, allowing products to be compared.

This European Standard specifies test methods and requirements for spindle and fastening elements, operating torques, permissible free play and safety, free angular movement and misalignment durability, static strength and corrosion resistance for sprung and unsprung lever handles and knobs for doors on backplates or roses.



JA-TEC SYSTEM
EN 1906 - 4

- Türgriffe auf Rosetten
- Zertifizierung EN 1906 (Gebrauchsklasse 4)

- Door handles on rosette
- Certification EN 1906 (Class 4)



SM SYSTEM
EN 1906 - 3

- Türgriffe auf Rosetten
- Zertifizierung EN 1906 (Gebrauchsklasse 3)

- Door handles on rosette
- Certification EN 1906 (Class 3)



R1 SYSTEM
EN 1906 - 4

- Türgriffe auf Rosetten
- Zertifizierung EN 1906 (Gebrauchsklasse 4)

- Door handles on rosette
- Certification EN 1906 (Class 4)



R16 SYSTEM
EN 1906 - 3

- Türgriffe auf Rosetten
- Zertifizierung EN 1906 (Gebrauchsklasse 3)

- Door handles on rosette
- Certification EN 1906 (Class 3)



FEUERSCHUTZ
FIRE PROOF

- Zertifizierung DIN 18273

- Certification DIN 18273



DK SYSTEM
EN 13126 - 3

- Zertifizierung EN 13126 (Gebrauchsklasse 3)

- Certification EN 13126 (Class 3)



4 POSITIONS SYSTEM

- Zertifizierung EN 13126 (Gebrauchsklasse 3)

- Certification EN 13126 (Class 3)



SECURBLOCK

- Zertifizierung EN 13126 (Gebrauchsklasse 3)

- Certification EN 13126 (Class 3)



SECURKEY

- Zertifizierung EN 13126 (Gebrauchsklasse 3)

- Certification EN 13126 (Class 3)



SECURKEY
RC2 RESISTANCE

- Zertifizierung EN 13126 (Gebrauchsklasse 3)

- Certification EN 13126 (Class 3)



SKG
CERTIFIED

- Zertifizierung EN 13126 (Gebrauchsklasse 3)

- Certification EN 13126 (Class 3)



TBT
FUNCTION

- Zertifizierung EN 13126 (Gebrauchsklasse 3)

- Certification EN 13126 (Class 3)

ZERTIFIZIERUNG CERTIFICATIONS

R1 SYSTEM

Das R1 System ist verwendbar bei Schildern und ovalen Rosetten mit JTC Türgriffen. Zertifizierung EN 1906 (Gebrauchsklasse 4)

R1 system is only suitable for door handles on plates and on oval and rectangular rose of the JTC line. Certification EN 1906 (Class 4)

Nachweis
Türdrücker und Türkäufe gemäß EN 1906 : 2010

Prüfbericht
Nr.: 21-022633-PR01
(PB-G53-03-se-01)

Auftraggeber
Giesse S.p.A.
Via Tubertino 1
40064 Budrio (BO)
Italien

Produkt
Türdrückergarnitur / Drücker / Drücker

Bezeichnung
System R1 / 800/D06-AB00MRD06

Leistungsebene / Produktfamilie
Material: Messing,
Lagerung: Drehbolz-Fest,
Drehmoment: 8,0 Nm,
Material-Dimensionen: Stahl, verzinkt
Gemäß der Montageanleitung des ursprünglichen
Beschlagherstellers.

Vertrag
keine

Spezifiks
Klassifizierung gemäß EN 1906 : 2010

Drücker- kategorie	Material	Verfahren	Produkt- familie	Drück- moment	Material- prüfung	Drücker- prüfung	Drücker- prüfung	Drücker- prüfung
4	7	-	0	0	0	4	0	A

ifft
ROSENHEIM

ifft Rosenheim
18.03.2022

K. Jung
Korrespondenz-Dir. Ing. (FH)
Prüfingenieur
Sicherheitsfach

Pascal Juy
Prüfingenieur
Sicherheitsfach

ifft
ROSENHEIM

ifft Rosenheim
18.03.2022

ifft
ROSENHEIM

(R1) TÜRGRIFFEN DOOR HANDLES

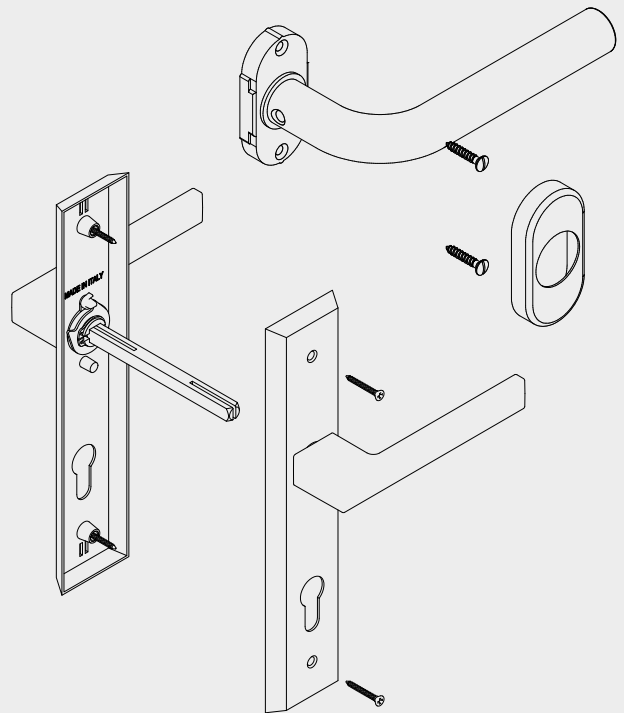

R16 SYSTEM

Das R16 System kann nur mit Türgriffen der JTC Serie verwendet werden. Zertifizierung EN 1906 (Gebrauchsklasse 3)

R16 system is only suitable for door handles on rose of JTC line. Certification EN 1906 (Class 3)

Nachweis
Türdrücker und Türkäufe gemäß EN 1906 : 2010

Prüfbericht
Nr.: 21-022633-PR02
(PB-G53-03-se-01)

Auftraggeber
Giesse S.p.A.
Via Tubertino 1
40064 Budrio (BO)
Italien

Produkt
Türdrückergarnitur / Drücker / Drücker

Bezeichnung
System R16 T / 478D16-AJ16MRD16

Leistungsebene / Produktfamilie
Material: Messing,
Lagerung: Drehbolz-Fest,
Drehmoment: 8,0 Nm,
Material-Dimensionen: Stahl, verzinkt
Gemäß der Montageanleitung des ursprünglichen
Beschlagherstellers.

Vertrag
keine

Spezifiks
Klassifizierung gemäß EN 1906 : 2010

Drücker- kategorie	Material	Verfahren	Produkt- familie	Drück- moment	Material- prüfung	Drücker- prüfung	Drücker- prüfung	Drücker- prüfung
3	7	-	0	0	0	4	0	A

ifft
ROSENHEIM

ifft Rosenheim
22.12.2021

K. Jung
Korrespondenz-Dir. Ing. (FH)
Prüfingenieur
Sicherheitsfach

Pascal Juy
Prüfingenieur
Sicherheitsfach

ifft
ROSENHEIM

ifft Rosenheim
22.12.2021

ifft
ROSENHEIM

(R16) TÜRGRIFFEN DOOR HANDLES

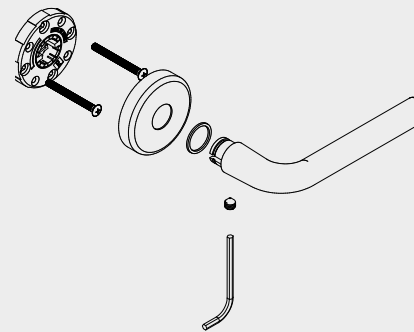

(R16) WECHSELGARNITUR MAIN ENTRY DOOR HANDLES

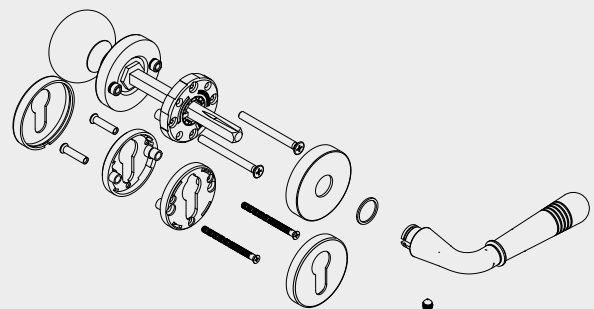

ZERTIFIZIERUNG CERTIFICATIONS

FEUERSCHUTZ FIRE PROOF

Die feuerfeste Oberfläche Edelstahl eignet sich perfekt für den Objektbau und entspricht den heutigen Standards. Die Feuerschutz Garnituren sind konform mit DIN EN 18273. Die Feuerschutz Sicherheitsgarnituren sind zertifiziert nach DIN 18273.

The fire-resistant surface in stainless steel is ideally suited for public buildings and corresponds to today safety standards. The fireproof door handles are conformity with the DIN 18273. The fire protection security sets are certified to DIN 18273.



Übereinstimmungszertifikat		ift ROSENHEIM
Zertifikatsnummer: 235-9020230-1-1		
Hiermit wird bestätigt, dass das/die Bauprodukte	Grundlagen: DIN 18273:1997-12	
Türdrückergarnituren für Feuerschutz- und Rauchschutztüren nach DIN 18273:1997		
Produktbezeichnung/ Spezifikation	Türdrückergarnitur System GF2	
In Verkehr gebracht unter dem Namen oder Warenzeichen	Giesse S.p.A. Via Tubicino 1, IT 40054 Budrio (BO)	
und hergestellt in dem Produktionsstandort/ des Produktions- standortes	Reguitti S.p.a. Fond. n. 33 Zona Industriale, IT 25071 Agnosine BS	
nach den Ergebnissen der werkseigenen Produktionskontrolle und der von der bauaufsichtlich anerkannten	der in der Verwaltungsvorschrift Technische Baubestimmungen (VVB) des Landes Bayern von Oktober 2016 Kapitel C2.6.9 bekannt gemachten technischen Regel DIN 18273:1997	
PIZ-Stelle	ift Rosenheim GmbH Theodor-Gietl-Str. 7-9 83026 Rosenheim	
Kennziffer	BAY 18	
durchgeführten Fremdüberwachung den Bestimmungen	entspricht/entsprechen.	
Der Hersteller ist somit berechtigt, das Bauprodukt mit dem Übereinstimmungszeichen (Ü-Zeichen) gemäß der Übereinstimmungszeichen-Verordnung zu kennzeichnen.		
Die Verwendung dieses Zertifikats und die Kennzeichnung der Produkte ist an den bestehenden Zertifizierungs- und Überwachungsvertrag mit dem ift Rosenheim Nr. 235-9020230 gebunden.		
Christian Kehrer Leiter der bauaufsichtlich anerkannten PIZ-Stelle	www.ift.de	
ift Rosenheim 19.04.2021		
ift Rosenheim GmbH Theodor-Gietl-Str. 7-9 D-83026 Rosenheim	ift Rosenheim Tel. +49 89 235 381-0 Fax. +49 89 235 381-330 www.ift-rosenheim.de	Prüfung und Zertifizierung – ift ISO/IEC 17025 Innovation – EN ISO/IEC 17021 Zertifizierung Produkte – EN ISO/IEC 17026 Zertifizierung Managementsysteme – EN ISO/IEC 17021
		Technik Berg 8197 www.ift.de

ZERTIFIZIERUNG CERTIFICATIONS

SCHUTZGARNITUREN - GF1 SECURITY SETS - GF1



Die Eingangstür ist die Visitenkarte jedes Hauses und verdient besondere Aufmerksamkeit. Die Jatec Komponenten geben jeder Tür einen individuellen Stil und erfüllen höchste Sicherheitsstandards. Sicherheit kann nur erreicht werden, wenn man alle Elemente einer Sicherheitstür nach der Norm DIN EN 18257 verwendet. Zertifizierung EN 1906 (Gebrauchsklasse 2)

The front door is the visiting card of every house and deserves special attention. It is the first and the last of doors and accessories in your home that is seen. The Jatec components give to each door a personalised style and meet the highest security standards. Indeed a security set applied to the front door must protect the lock from a direct mechanical action and effectively hinder a forced twisting of the cylinder profile. Maximum security can only be achieved if you use all security door's elements, according to DIN EN 18257. Certification EN 1906 (Class 2)

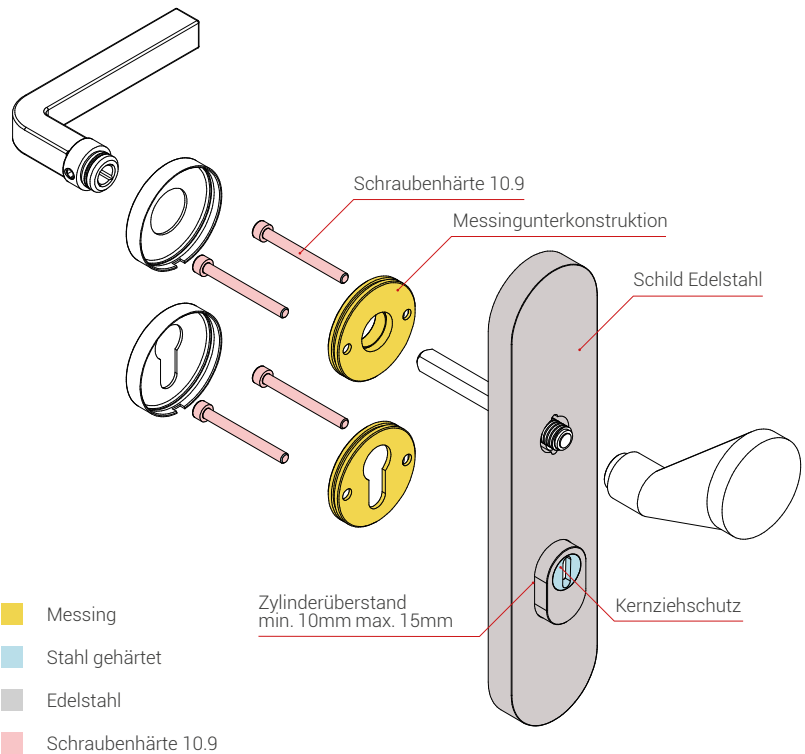
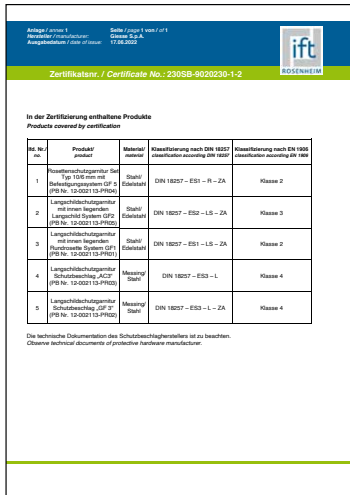

- Messing
- Stahl gehärtet
- Edelstahl
- Schraubenhärte 10.9

Eigenschaften Characteristics

Erfordernisse / Requirements

	ES0 (SK1)	ES1 (SK2)	ES2 (SK3)	ES3 (SK4)
Antrieb Beanspruchung der Zylinderabdeckung (ZA) / Traction stress of the cylinder cover	--	10 kN	15 kN	20 kN
Solidität von Befestigungselementen / Solidity of fastening elements	10 kN	15 kN	20 kN	30 kN

1 N (Newton) ist die erforderliche Kraftmenge, um eine Masse von einem Kilogramm von einem Meter pro Sekunde im Quadrat zu beschleunigen.

1 N (Newton) is defined as the amount of force required to accelerate a mass of one kilogram of a meter per second squared.

ZERTIFIZIERUNG CERTIFICATIONS

SCHUTZGARNITUREN - GF2 SECURITY SETS - GF2



Die Eingangstür ist die Visitenkarte jedes Hauses und verdient besondere Aufmerksamkeit. Die Jatec Komponenten geben jeder Tür einen individuellen Stil und erfüllen höchste Sicherheitsstandards. Sicherheit kann nur erreicht werden, wenn man alle Elemente einer Sicherheitstür nach der Norm DIN EN 18257 verwendet. Zertifizierung EN 1906 (Gebrauchsklasse 3)

The front door is the visiting card of every house and deserves special attention. It is the first and the last of doors and accessories in your home that is seen. The Jatec components give to each door a personalised style and meet the highest security standards. Indeed a security set applied to the front door must protect the lock from a direct mechanical action and effectively hinder a forced twisting of the cylinder profile. Maximum security can only be achieved if you use all security door's elements, according to DIN EN 18257. Certification EN 1906 (Class 3)

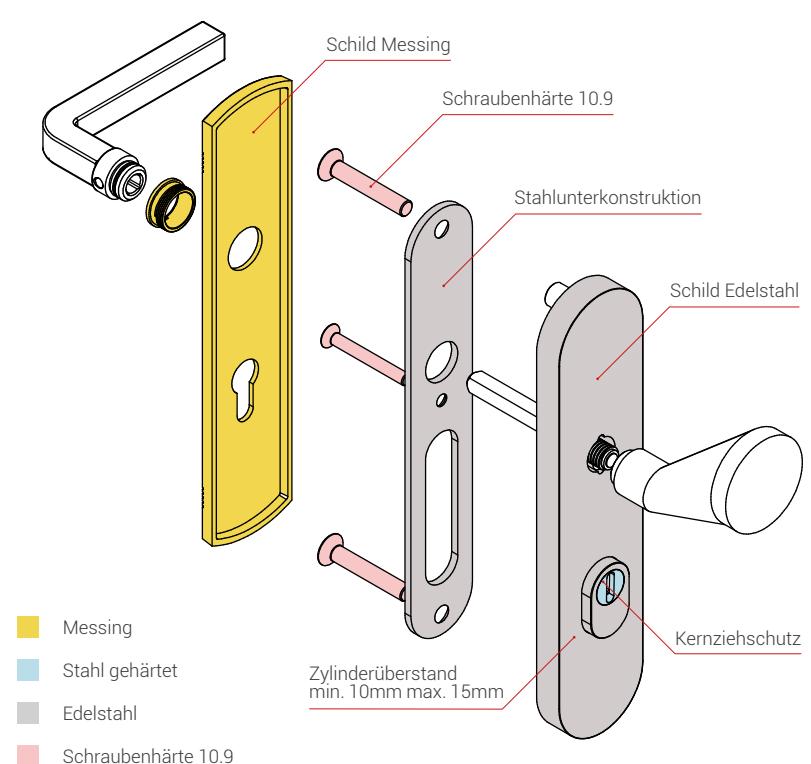
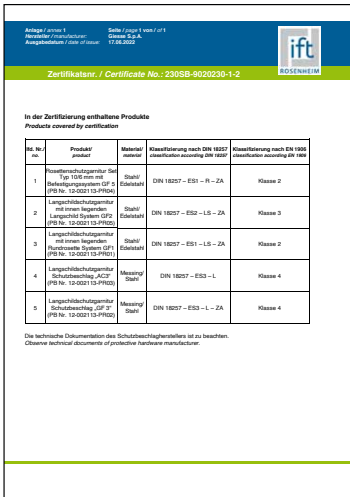

- Messing
- Stahl gehärtet
- Edelstahl
- Schraubenhärte 10.9

Eigenschaften Characteristics

Erfordernisse / Requirements

	ES0 (SK1)	ES1 (SK2)	ES2 (SK3)	ES3 (SK4)
Antrieb Beanspruchung der Zylinderabdeckung (ZA) Traction stress of the cylinder cover	--	10 kN	15 kN	20 kN
Solidität von Befestigungselementen Solidity of fastening elements	10 kN	15 kN	20 kN	30 kN

1 N (Newton) ist die erforderliche Kraftmenge, um eine Masse von einem Kilogramm von einem Meter pro Sekunde im Quadrat zu beschleunigen.

1 N (Newton) is defined as the amount of force required to accelerate a mass of one kilogram of a meter per second squared.

ZERTIFIZIERUNG CERTIFICATIONS

SCHUTZGARNITUREN - GF3 SECURITY SETS - GF3



Die Eingangstür ist die Visitenkarte jedes Hauses und verdient besondere Aufmerksamkeit. Die Jatec Komponenten geben jeder Tür einen individuellen Stil und erfüllen höchste Sicherheitsstandards. Sicherheit kann nur erreicht werden, wenn man alle Elemente einer Sicherheitstür nach der Norm DIN EN 18257 verwendet. Zertifizierung EN 1906 (Gebrauchsklasse 4)

The front door is the visiting card of every house and deserves special attention. It is the first and the last of doors and accessories in your home that is seen. The Jatec components give to each door a personalised style and meet the highest security standards. Indeed a security set applied to the front door must protect the lock from a direct mechanical action and effectively hinder a forced twisting of the cylinder profile. Maximum security can only be achieved if you use all security door's elements, according to DIN EN 18257. Certification EN 1906 (Class 4)

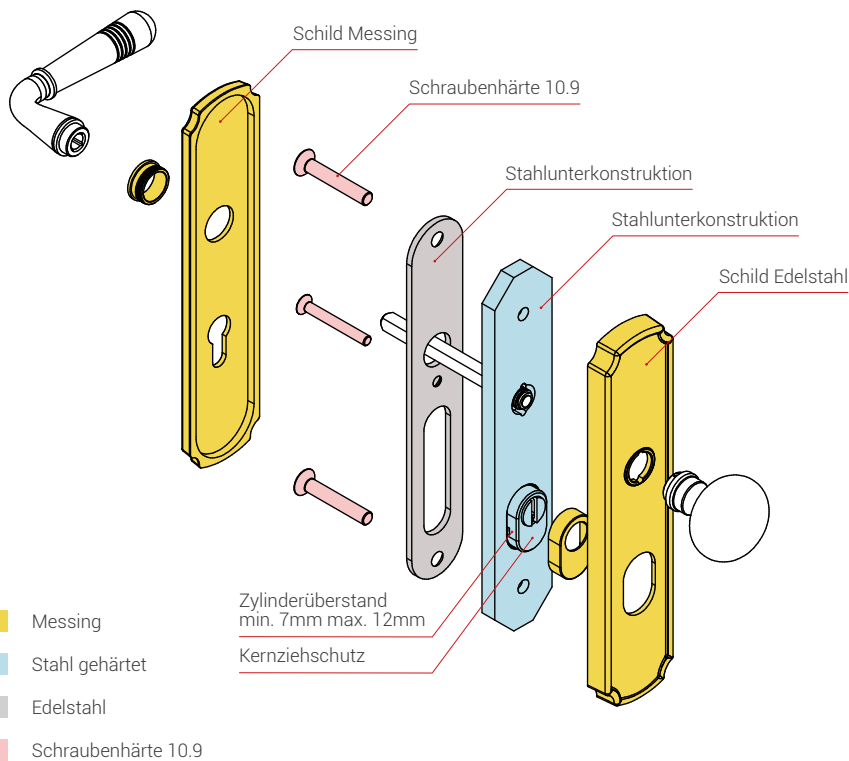
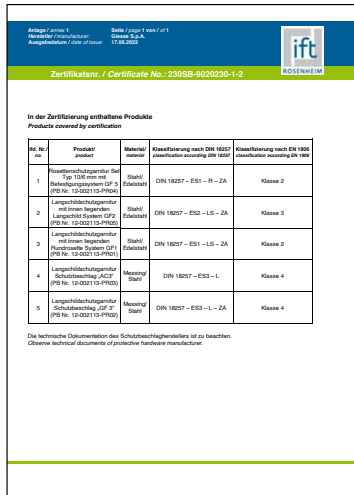

Eigenschaften
Characteristics

Erfordernisse / Requirements

	ES0 (SK1)	ES1 (SK2)	ES2 (SK3)	ES3 (SK4)
Antrieb Beanspruchung der Zylinderabdeckung (ZA) Traction stress of the cylinder cover	--	10 kN	15 kN	20 kN
Solidität von Befestigungselementen Solidity of fastening elements	10 kN	15 kN	20 kN	30 kN

1 N (Newton) ist die erforderliche Kraftmenge, um eine Masse von einem Kilogramm von einem Meter pro Sekunde im Quadrat zu beschleunigen.

1 N (Newton) is defined as the amount of force required to accelerate a mass of one kilogram of a meter per second squared.

ZERTIFIZIERUNG CERTIFICATIONS



SCHUTZGARNITUREN - AC3 SECURITY SETS - AC3

Die Eingangstür ist die Visitenkarte jedes Hauses und verdient besondere Aufmerksamkeit. Die Jatec Komponenten geben jeder Tür einen individuellen Stil und erfüllen höchste Sicherheitsstandards. Sicherheit kann nur erreicht werden, wenn man alle Elemente einer Sicherheitstür nach der Norm DIN EN 18257 verwendet. Zertifizierung EN 1906 (Gebrauchsklasse 4)

The front door is the visiting card of every house and deserves special attention. It is the first and the last of doors and accessories in your home that is seen. The Jatec components give to each door a personalised style and meet the highest security standards. Indeed a security set applied to the front door must protect the lock from a direct mechanical action and effectively hinder a forced twisting of the cylinder profile. Maximum security can only be achieved if you use all security door's elements, according to DIN EN 18257. Certification EN 1906 (Class 4)

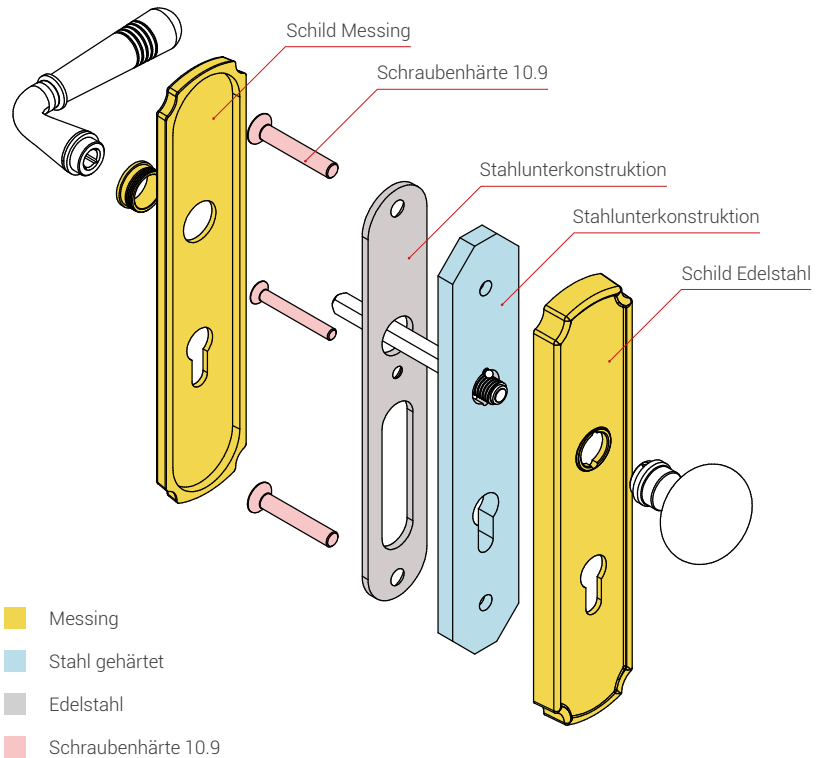
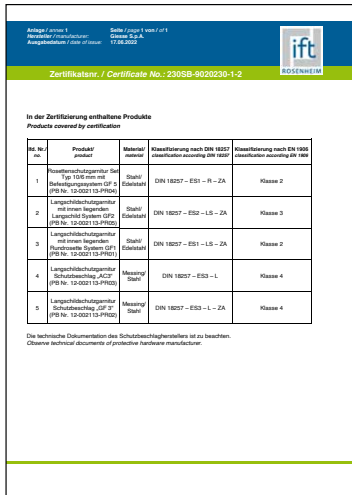

Eigenschaften Characteristics

Erfordernisse / Requirements

	ES0 (SK1)	ES1 (SK2)	ES2 (SK3)	ES3 (SK4)
	Antrieb Beanspruchung der Zylinderabdeckung (ZA) Traction stress of the cylinder cover	--	10 kN	15 kN
Solidität von Befestigungselementen Solidity of fastening elements	10 kN	15 kN	20 kN	30 kN

1 N (Newton) ist die erforderliche Kraftmenge, um eine Masse von einem Kilogramm von einem Meter pro Sekunde im Quadrat zu beschleunigen.

1 N (Newton) is defined as the amount of force required to accelerate a mass of one kilogram of a meter per second squared.

ZERTIFIZIERUNG CERTIFICATIONS

MIT VIER RASTERUNGEN 4 POSITIONS

4

Die DK 4 Positionen ermöglicht den Einsatz als TBT Beschlag.

SPLINDENLÄNGE 7MM

A Standard = 30 mm and 35 mm

Auf Anfrage bis zu 85 mm

Zertifizierung en 13126-3

The DK 4 positions includes the M1 mechanism suitable for tilt and spindle windows.

7MM SPLINDE LENGTH

A Standard = 30 mm and 35 mm

On request up to 85 mm

Certification EN 13126-3

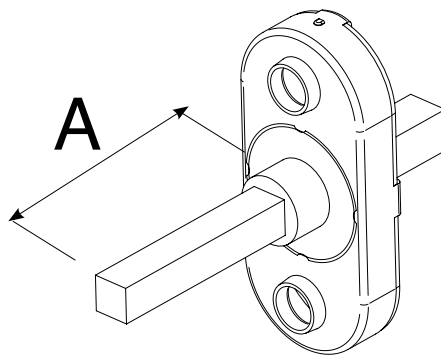

DKE69

- Zertifizierung en 13126-3
- Certification EN 13126-3

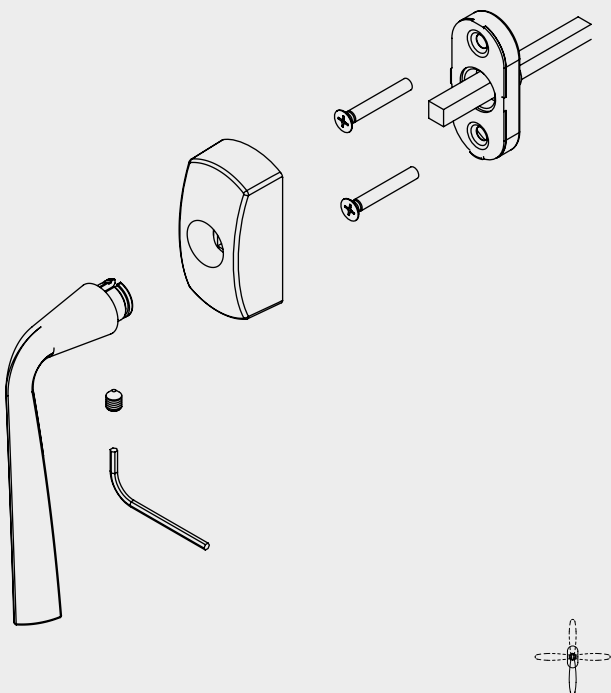

DKE66

- Zertifizierung en 13126-3
- Certification EN 13126-3

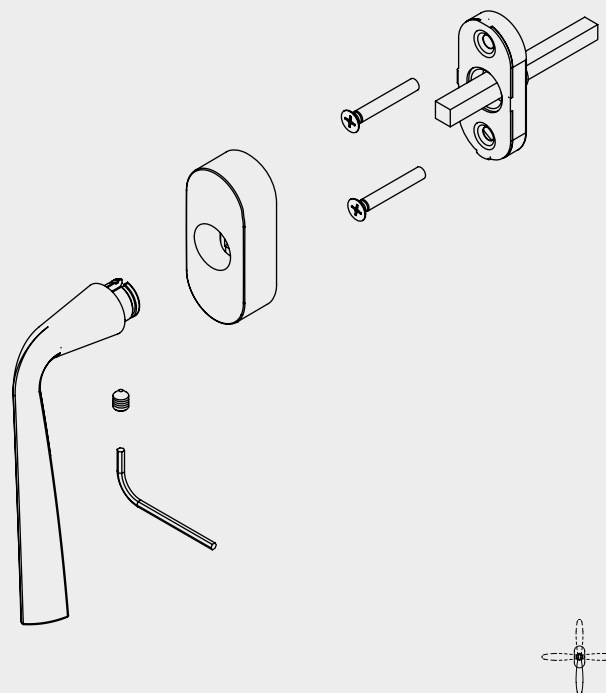

DKE82

- Zertifizierung en 13126-3
- Certification EN 13126-3

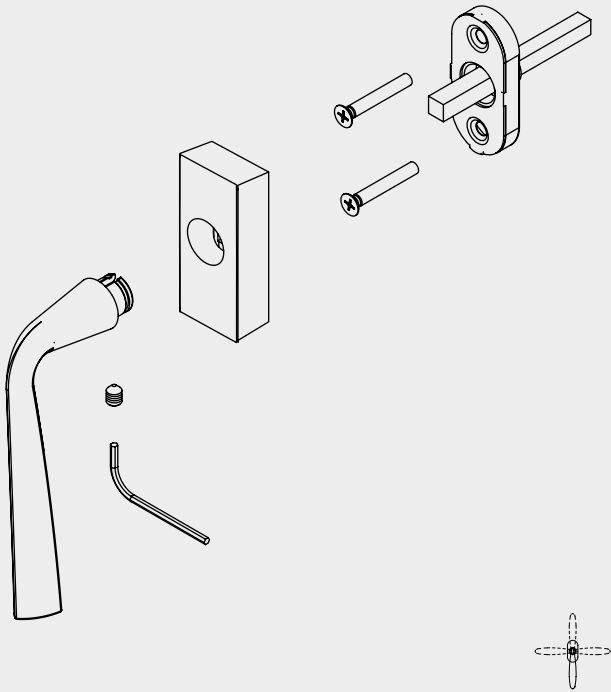

DK015

- Zertifizierung en 13126-3
- Certification EN 13126-3

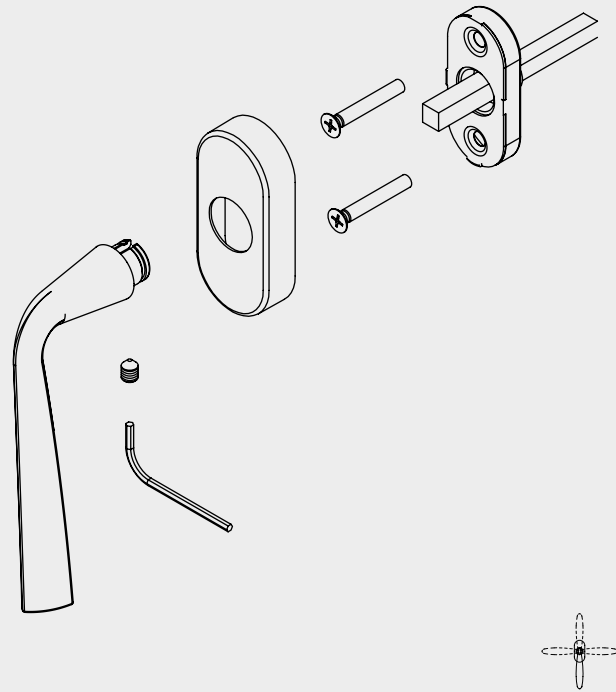

DKQ15

- Zertifizierung en 13126-3
- Certification EN 13126-3

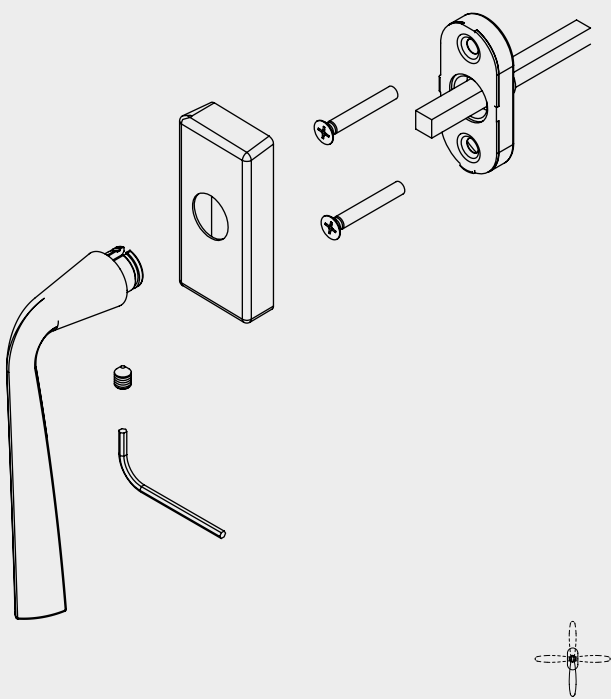

ZERTIFIZIERUNG

CERTIFICATIONS

SECURBLOCK MIT DRUCKKNOPF

SECURBLOCK SECURITY



SECURBLOCK ist der selbstverriegelnde Fenstergriff mit Druckknopf zum entsperren.

EIGENSCHAFTEN:

1. System geeignet für alle unsere JTC-Griffe.
 2. Metallmechanismus.
 3. Einfache Bedienung und einfache Fenstermontage.
- Zertifizierung en 13126-3

SECURBLOCK is the self-locking DK safety window handle with push button.

FEATURES:

1. System suitable to all of our JTC handles.
 2. Metal Mechanism.
 3. Simple operation and easy window assembly.
- Certification EN 13126-3

DKQ75

- Zertifizierung en 13126-3
- Certification EN 13126-3

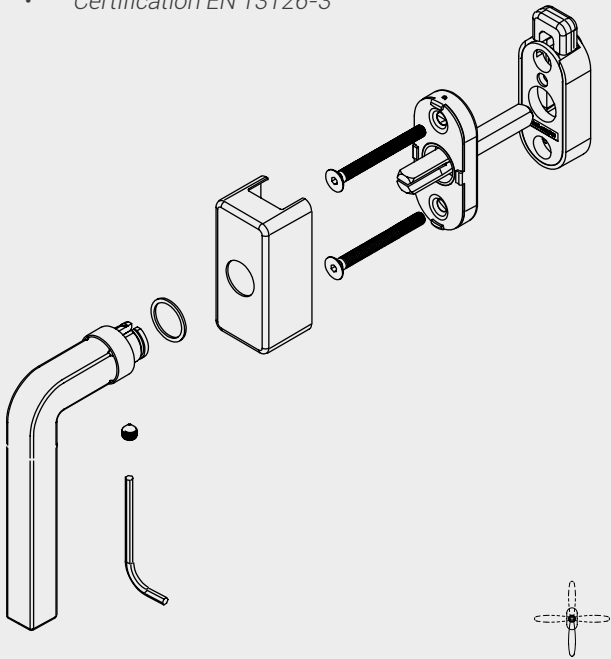

DK075

- Zertifizierung en 13126-3
- Certification EN 13126-3

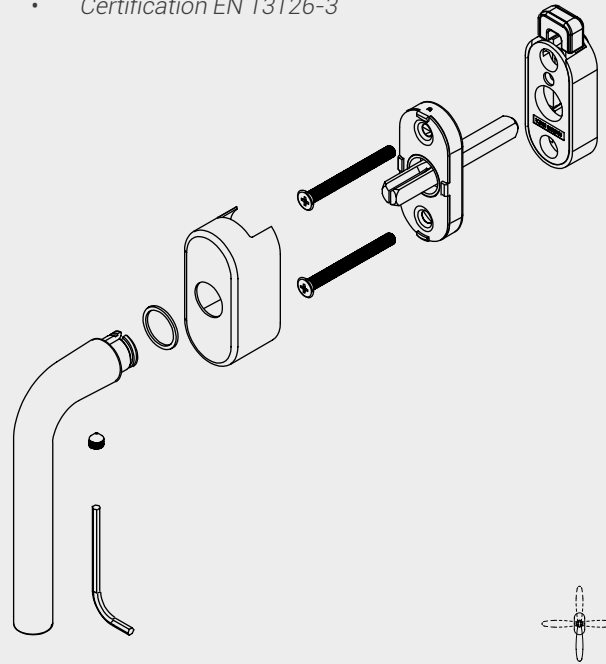

Gesperrt
Locked

immer aktives Gerät
Device always active

Gesperrt
Locked

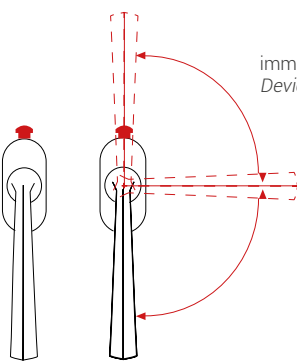

Gesperrt
Locked

Wahl der Knopfsposition oben und unten
Push button position, possible on top or at the bottom

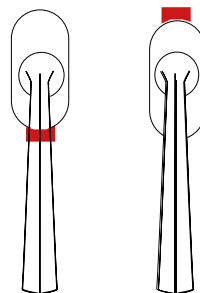

Stiftabstand
Spindle projector
30-35-50

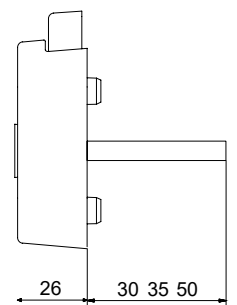

ZERTIFIZIERUNG CERTIFICATIONS

ABSCHLIESSBARER FENSTERGRIFF MIT DRUCKZYLINDER SECURITY WITH CYLINDER AND KEY



Sicherheitsfenstergriffe mit Zylinder und 2 Schlüssel
8/7x30 und 35 mm Vierkantstift. Verfügbar auf Anfrage
bis 85 mm.
Zertifizierung en 13126-3

*Safety window handles with cylinder and key alike system
with 2 keys for cylinder (KA) with metal mechanism 8/7x30
and 35 mm spindle. Available on request up to 85 mm.
Certification EN 13126-3*

DKE70

- Zertifizierung en 13126-3
- Certification EN 13126-3

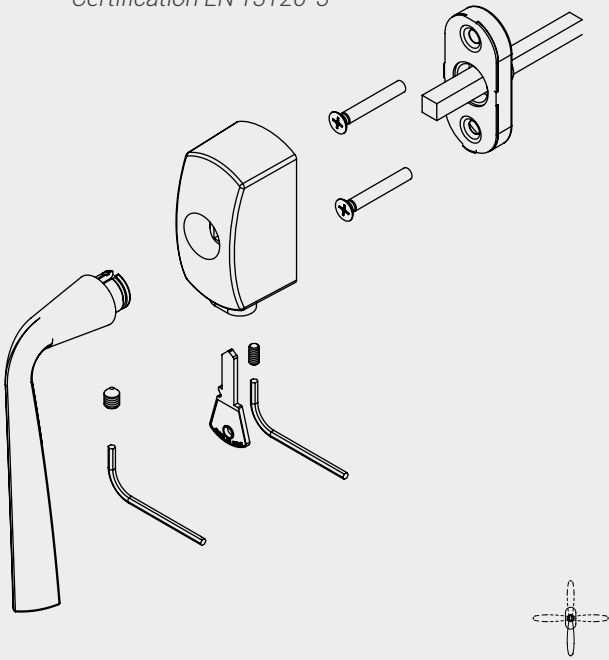

ZERTIFIZIERUNG CERTIFICATIONS

ABSCHLIESSBARER FENSTERGRIFF RC2 ZERTIFIZIERT 100NM SECURITY RC2 RESISTANCE 100NM



Einige Modelle des Jatec Fensteroliven Sortimentes sind auch in der zertifizierten Version RC2 mit 100 Nm verfügbar, entweder mit ovalen Rosette C80 oder mit rechteckigen Rosette C81.
Zertifizierung en 13126-3

*Some models of Jatec window handles assortment are also available in the certificated version RC2 with 100 Nm, either with oval rosette C80 or with rectangular rosette C81.
Certification EN 13126-3*

DKC80

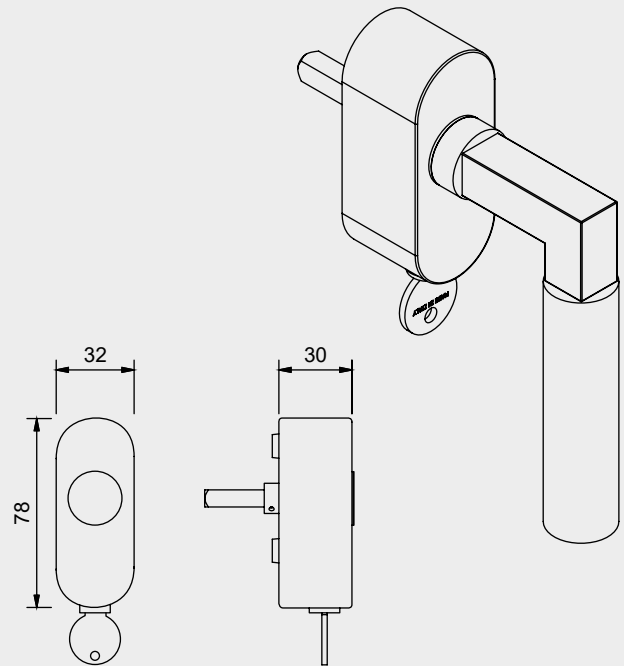

DKC81

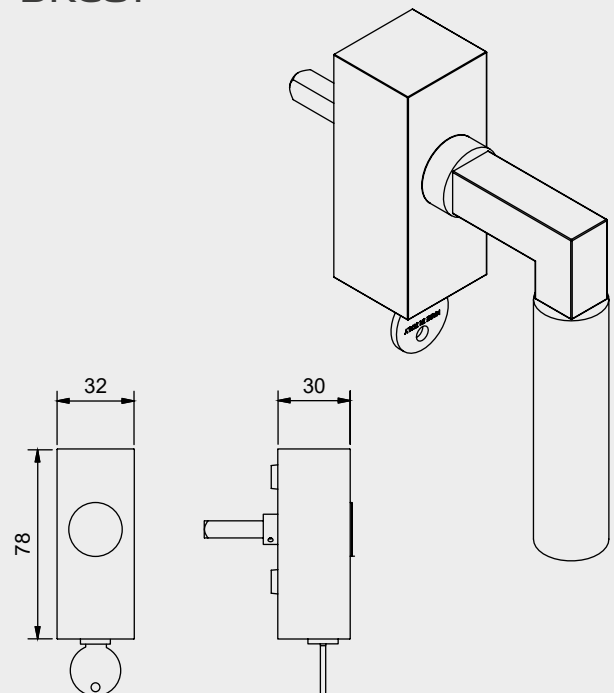

Nachweis
Baubeschläge, Beschläge für Fenster und Fenstertüren
gemäß EN 13126-3 : 2011

Prüfbericht
Nr.: 21-002003-PRO05
(PB+KB-G05-03-0a-01)

Auftraggeber Glasco S.p.A.
Via Tubertini
40054 Budrio (BO)
Italien

Produkt drehbarer Fenstergriff mit Rastung
Abschließbare Fensterolive System DK RC2

Bestimmung Ausführung: Fenstergriff mit Stahlverkant
Auswahl: Messing / Zinn
Befestigungsbreite: 43 mm
Art der Befestigung: geschraubt
Anzahl der Befestigungselemente: 2 Stück
Befestigungsdurchmesser: M5 x 50 mm, M5 x 40 mm
Griffhöhe: ca. 21 mm
Grifflänge: ca. 130 mm

Hersteller Jatec

Ergebnis
Konformitätsgemäß EN 13126-3 : 2011

Gr- klasse	Druck- festigkeit	Werk- stoff	Gr- stärke	Gr- stärke	Gr- stärke	Schutz- verzug	Anwen- dung	Prüf- stellen
1	5/180	-	0	1	4	20	3C1	-

ifft
ROSENHEIM

ifft Rosenheim
22.12.2021

Wolfgang Grottel
Prüfingenieur / Der-Ing (FH)
Sachverständiger

Klaus Heilmann
Prüfingenieur /
Sachverständiger

Prüfungsort Rosenheim

Prüfungstermin 22.12.2021

Prüfungsdauer ca. 10 h

Prüfungskosten ca. 1.500,- €

Prüfungskosten ca. 1.500,- €

Prüfungskosten ca. 1.500,- €

Prüfungskosten ca. 1.500,- €

MONTAGEANLEITUNG

MOUNTING INSTRUCTIONS

JA-TEC SYSTEM

1.

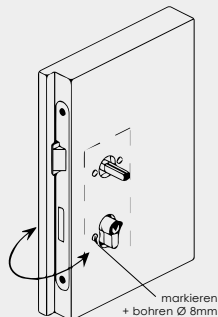

HINWEIS / INDICATION

Von beiden Seiten der Türe bohren und Bohrspäne entfernen.

Drill and remove bore chips from both sides of the door

2.

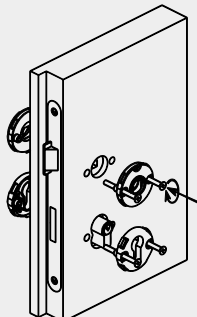

MONTAGE / MOUNTING

Bilder 2 bis 6

Pictures from nr. 2 until nr. 6

3.

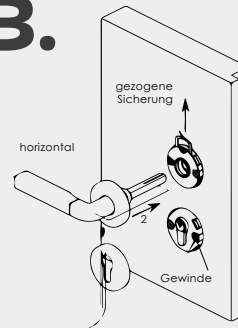

Erst auf der Türseite montieren, auf die Schraubenköpfe nicht zu sehen sind.

Firstly, mount on the door side on which the screw heads are not to be seen first, mount on the side of the door on which the screw heads are not visible.

4.

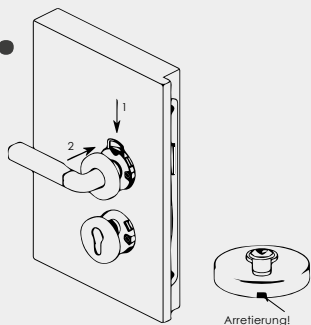

Montageanleitung für Rosettengarnituren

Mounting instruction for rosettes set

5.

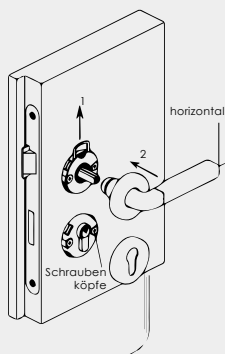

6.

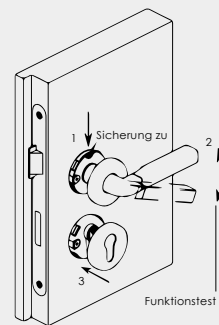

Probleme bei Funktionstest? Siehe Tabelle.

Problems with functional testing? See the table.

7.

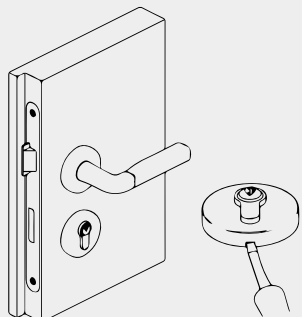

DEMONTAGE / DISMOUNTING

Rosetten mittels Schraubendreher zwischen Arretierung und Rosetten abheben, Sicherung und Drücker abnehmen

Take off the rosette with a screwdriver between locking and rosette, remove the security lock and the handle.

Problem nach der Montage?
Problems after the assembling?

Ursache
Reason

Abhilfe
Solution

Nach Betätigung geht der Drücker nicht in seine Ausgangsposition zurück

After pressing the handle does not return to its original position

Verschraubung ist zu stark angezogen

Screw is tightened too much

Verspannungen in der Schlossnuss wegen leichten Versatz der gebohrten Löcher

Tension in the lock nut because of slight offset of the drilled holes

Verschraubung gleichmäßig etwas lösen

Loosen screw uniformly

Garnitur demontieren die Nocken-Bohrungen auf $\varnothing 8,5$ mm aufbohren

Set dismantle and drill out the cam bores to $\varnothing 8.5$ mm

MONTAGEANLEITUNG

MOUNTING INSTRUCTIONS

JA-TEC SYSTEM - GARNITUREN PZ, BB, WC

JA-TEC SYSTEM - DOOR HANDLE SETS

8 mm VK - 8 mm Spindle

Türstärke mm Door thickness	Schraube Screw	Drückerstift Lever spindle
38 - 42	M5x50	8x95
42 - 45	M5x55	
45 - 50	M5x60	8x105
50 - 55	M5x65	
55 - 60	M5x70	8x115
60 - 65	M5x75	8x120
65 - 70	M5x80	
70 - 75	M5x85	8x130
75 - 80	M5x90	
80 - 85	M5x95	8x140
85 - 90	M5x100	
90 - 95	M5x85 + EXTENSION	8x150
95 - 100	M5x90 + EXTENSION	
100 - 105	M5x95 + EXTENSION	8x160
105 - 110	M5x100 + EXTENSION	

10/8 mm VK - 10/8 mm Spindle

Türstärke mm Door thickness	Schraube Screw	Drückerstift Lever spindle
38 - 42	M5x50	10/8x95
42 - 45	M5x55	
45 - 50	M5x60	8x105
50 - 55	M5x65	
55 - 60	M5x70	8x115
60 - 65	M5x75	10/8x120
65 - 70	M5x80	
70 - 75	M5x85	8x130
75 - 80	M5x90	
80 - 85	M5x95	8x140
85 - 90	M5x100	
90 - 95	M5x85 + EXTENSION	8x150
95 - 100	M5x90 + EXTENSION	
100 - 105	M5x95 + EXTENSION	8x160
105 - 110	M5x100 + EXTENSION	

MONTAGEANLEITUNG

MOUNTING INSTRUCTIONS

JA-TEC SYSTEM - WECHSEL GARNITUREN

JA-TEC SYSTEM - MAIN ENTRY DOOR HANDLE SETS

8 mm VK - 8 mm Spindle

Türstärke mm Door thickness	Schraube Screw	Drückerstift Lever spindle
38 - 42		8x68
42 - 45	M5x50	
45 - 50	M5x55	8x78
50 - 55	M5x60	
55 - 60	M5x65	8x88
60 - 65	M5x70	
65 - 70	M5x75	8x98
70 - 75	M5x80	
75 - 80	M5x85	8x108
80 - 85	M5x90	
85 - 90	M5x95	8x118
90 - 95	M5x100	
95 - 100	M5x80 + EXTENSION	8x128
100 - 105	M5x85 + EXTENSION	
105 - 110	M5x90 + EXTENSION	8x138
110 - 115	M5x95 + EXTENSION	
115 - 120	M5x100 + EXTENSION	8x148

10/8 mm VK - 10/8 mm Spindle

Türstärke mm Door thickness	Schraube Screw	Drückerstift Lever spindle
38 - 42		10/8x68
42 - 45	M5x50	
45 - 50	M5x55	10/8x78
50 - 55	M5x60	
55 - 60	M5x65	10/8x88
60 - 65	M5x70	
65 - 70	M5x75	10/8x98
70 - 75	M5x80	
75 - 80	M5x85	10/8x108
80 - 85	M5x90	
85 - 90	M5x95	10/8x118
90 - 95	M5x100	
95 - 100	M5x80 + EXTENSION	10/8x128
100 - 105	M5x85 + EXTENSION	
105 - 110	M5x90 + EXTENSION	10/8x138
110 - 115	M5x95 + EXTENSION	
115 - 120	M5x100 + EXTENSION	10/8x148

MONTAGEANLEITUNG

MOUNTING INSTRUCTIONS

SM SYSTEM - DRÜCKERGARNITUREN PZ, BB 8/72; WC 8/78

SM SYSTEM - DOOR HANDLE SETS PROFILE CYLINDER
KEY HOLE, STANDARD LEVER KEY HOLE 8/72, WC 8/78

8 mm VK - 8 mm Spindle

Türstärke mm Door thickness	Schraube Screw
38 - 45	8x95
45 - 55	8x105
55 - 65	8x120
65 - 75	8x130
75 - 85	8x140
85 - 95	8x150
95 - 105	8x160
105 - 115	8x170

SM SYSTEM - WECHSEL GARNITUREN

SM SYSTEM - MAIN ENTRY DOOR HANDLE SETS

8 mm VK - 8 mm Spindle

Türstärke mm Door thickness	Schraube Screw
38 - 45	8x68
45 - 55	8x78
55 - 65	8x88
65 - 75	8x98
75 - 85	8x108
85 - 95	8x118
95 - 105	8x128
105 - 115	8x138

MONTAGEANLEITUNG

MOUNTING INSTRUCTIONS

JA-TEC SYSTEM

Türgriffe der JTC Serien sind auch mit Rosetten ohne Stütznocken verfügbar.
Kein Aufschlag für Garnituren ohne Stütznocken.





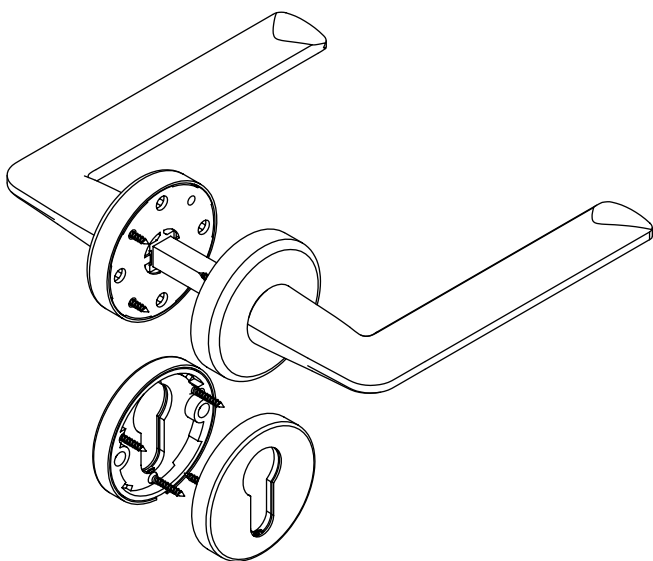

For door handles of JTC line it is possible to have on request handles on rose without bushes for applications for NON-DACH markets.

No extra price for Lever handles on rose without bushes.

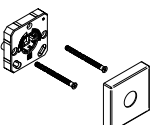
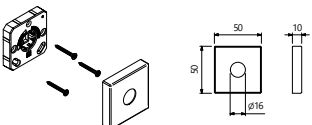
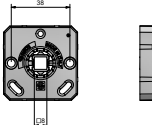

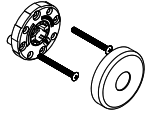
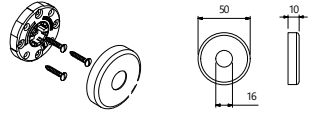
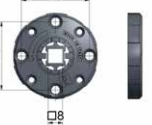
ALTERNATIVE ROSETTEN FÜR EXPORT-MÄRKTE

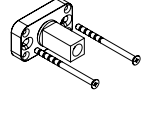
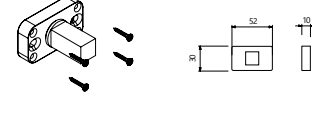
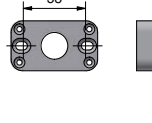
ALTERNATIVE ROSETTES FOR NON-DACH MARKETS

STANDARD ROSETTEN STANDARD ROSETTES	ALTERNATIVE ROSETTEN ALTERNATIVE ROSETTES	ALTERNATIVE UNDER ROSE ALTERNATIVE UNDER ROSE	SYSTEM SYSTEM	PREIS PRICE	MOQ MOQ
MRQD7 / EN 1906-3 	MRQ17 / EN 1906-3 	Made in Italy / Nylon 		AUF ANFRAGE ON REQUEST	100 SETS
MRD17 / EN 1906-3 	MR817 / EN 1906-3 	Made in Italy / Nylon 		AUF ANFRAGE ON REQUEST	100 SETS
MR1DN / EN 1906-4 	MR10N / EN 1906-4 	Aluminium 		AUF ANFRAGE ON REQUEST	100 SETS

MONTAGEANLEITUNG

MOUNTING INSTRUCTIONS

MINIMAL ROSETTE



FLÄCHBÜNDIGE ROSETTE 2 MM HOCH
 MINIMAL ROSE 2 MM THICKNESS

TÜRBOHREN MINIMAL DRÜCKERROSETTEN
 DOOR DRILLING MINIMAL ROSES



MR022

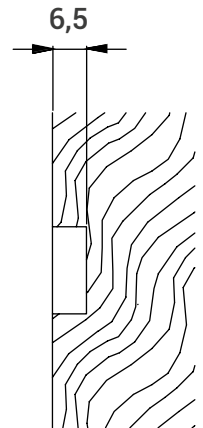
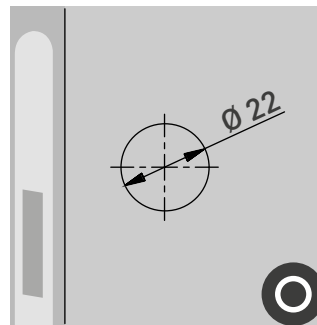

TÜRBOHREN MINIMAL SCHLÜSSELROSETTEN
 DOOR DRILLING MINIMAL ESCUTCHEONS



022 BN 503N0022

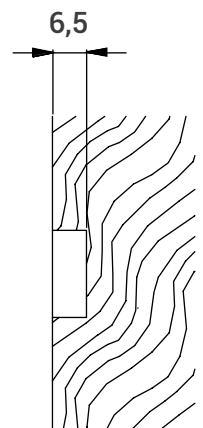
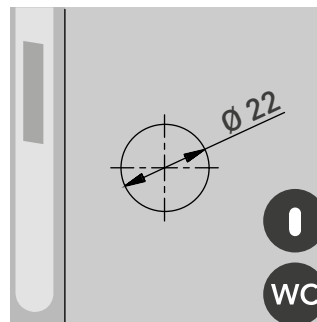
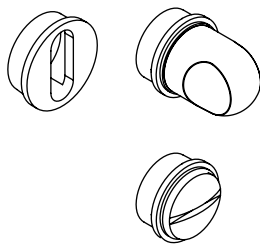

022 BY

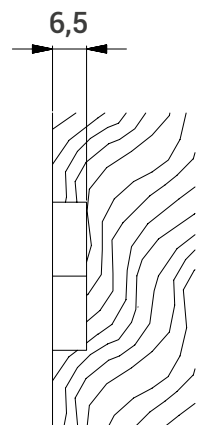
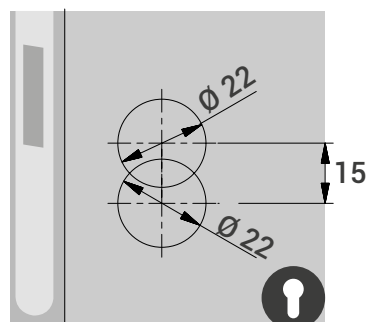
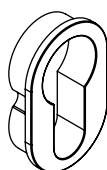

MONTAGEANLEITUNGEN MINIMAL ROSE

ASSEMBLING TEMPLATE MINIMAL ROSES

A - Fügen Sie das Schloss in die Tür ein.

B/C - Bohren Sie die Tür mit einem Loch- Ø von 22 mm und achten Sie dabei darauf, dass die Bohrung perfekt mit der Vierkant-Bohrung übereinstimmt. Es wird empfohlen, unser Werkzeug mit der quadratischen Bohrspitze zu nutzen.

D - Führen Sie den 8 mm Vierkant in die Schlossbohrung ein.

E/F - Setzen Sie die Bohrschablone auf den Vierkant und fixieren Sie diese parallel zur Türkante mit Hilfe von Klebestreifen. Bohren Sie, an dem angegebenen Punkt in der Mitte der Bohrschablone, ein Loch mit Durchmesser 22 mm. Es wird empfohlen, Werkzeug mit der Bohrspitze mit Fräse zu nutzen.

G - Geben Sie geeigneten Kleber auf die Drücker- und Schlüsselrosette und fügen Sie diese in die vorher gebohrten Löcher ein.

H - Montieren Sie das Lochteil auf den Vierkant und ziehen Sie die Madeschraube fest an.

A - Door comprehensive of lock.

B/C - Drill the Ø22 mm door handle hole and make sure that it is perfectly aligned with the square hole of the lock. Recommended tool with 8x8 mm spindle mounted (1).

D - Insert the 8 mm (3) square spindle supplied with the door handle into the square lock hole.

E/F - Insert the template into the square spindle and fixing it parallel to the door with adhesive tape. Drill the Ø22 mm key escutcheon hole centering the reference point shown on the template. Recommended tool with drill bit mounted (2).

G - Apply proper glue on the edge of roses and key escutcheons and insert them into the appropriate door holes.

H - Insert the lever handles in the square spindle (3). Tighten the grub screw (4) with the key supplied (5).

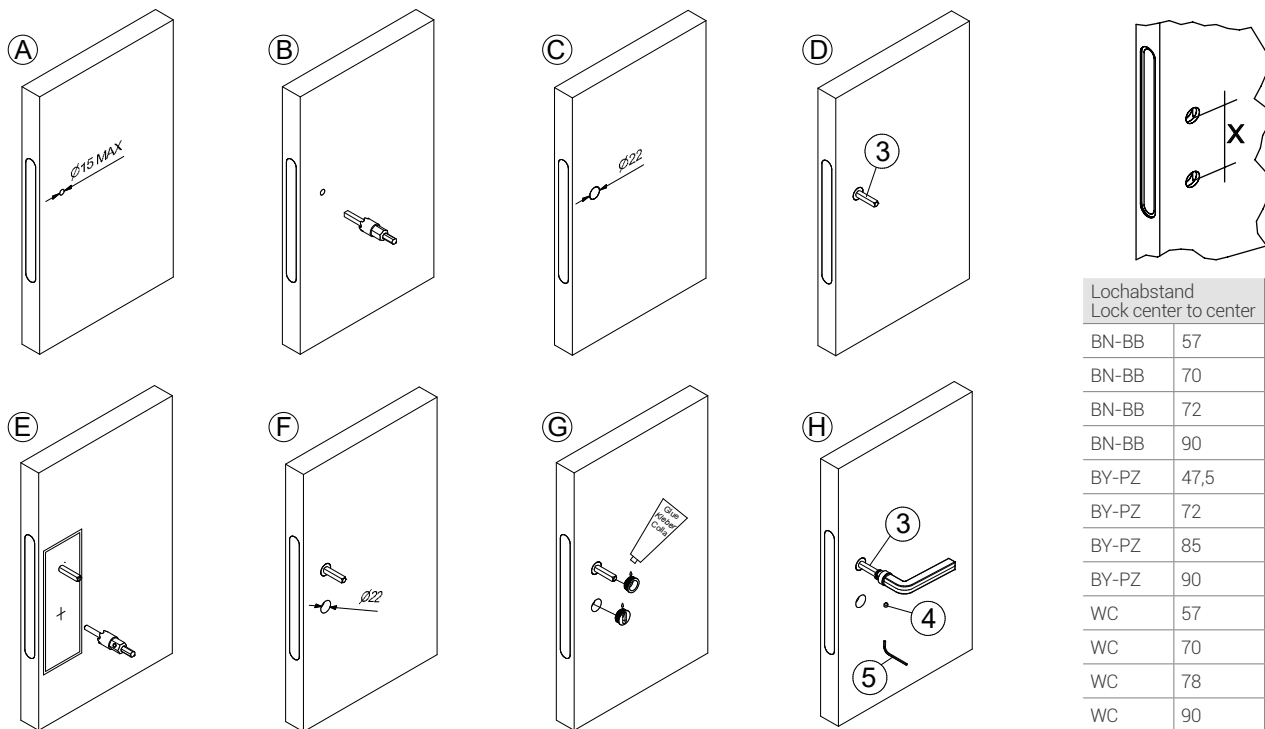

SMG SYSTEM

Das SMG System ist das System für weitere Verbesserung der Befestigung von Türgriffen an Türen mit speziellem Vierkantstift und perforierenden Madenschrauben CDF6

SMG System (Mounting System Guaranteed) is the system for further improving the fixing of door handles on doors with special spindle and perforating grub screws CDF6



BF22VM00M - € 79,87

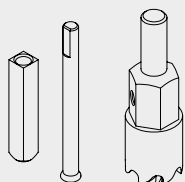

AUF ANFRAGE
Ø 22 mm Fräsbohrer Set mit 8x8 mm Vierkant und Fräse.

ON REQUEST
Ø 22 mm drill miller with 8x8 spindle and drill bit



Bohrspitze mit Fräse (1)
Drill miller with 8x8 mm spindle (1)



Bohrspritze quadratisch (2)
Drill miller with drill bit (2)

MONTAGEANLEITUNG

MOUNTING INSTRUCTIONS

SLIM ROSETTE 5 MM HOCH

SLIM ROSE 5 MM THICKNESS



Die Slim Rosette zeichnet sich durch ein modernes Design mit einer Stärke von nur 5 mm aus und ist in der runden und eckigen Version erhältlich. Die Rosette enthält eine Feder und die einfache Montage erfordert kein spezielles Bohren der Tür.

The slim rose is characterized by a modern design with a thickness of only 5 mm and is available in the round and square version. The rosette includes a spring and the easy installation does not require any special drilling of the door.

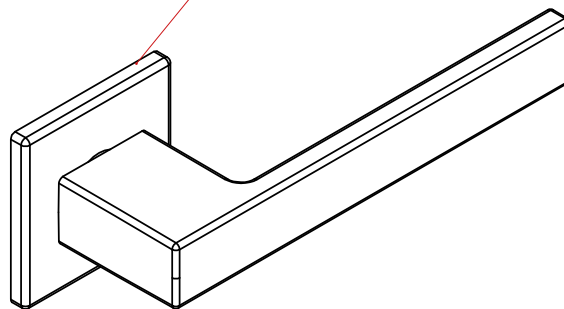
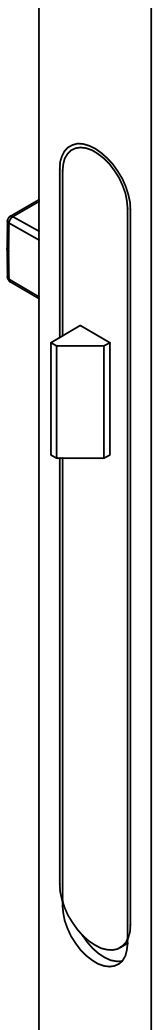
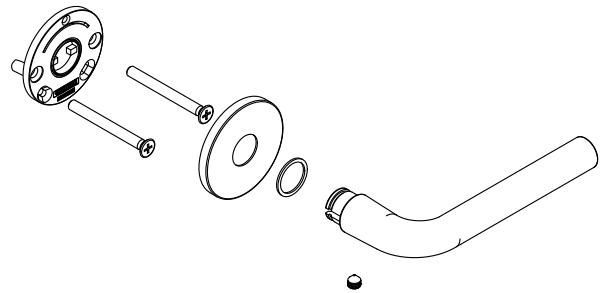
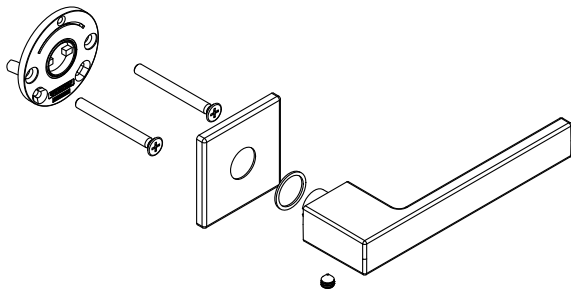

Rosettenstärke
Rose thickness
5mm

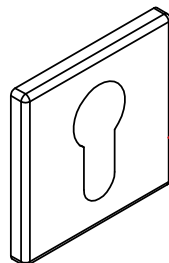

Schlüsselrosettenstärke
Eschutcheons to match
5mm



SLIM ROSE
5 MM



EASY AND QUICK
INSTALLATION



WITH
SPRING

MONTAGEANLEITUNG

MOUNTING INSTRUCTIONS

FEUERSCHUTZ - GARNITUREN PZ, FEUERSCHUTZ

FIRE PROOF - DOOR HANDLE SETS, FIRE RESISTANT

9 mm VK - 9 mm Spindle

Türstärke mm Door thickness	Schraube Screw	Drückerstift Lever spindle
38 - 42	M5x50	
42 - 45	M5x55	9x95
45 - 50	M5x60	
50 - 55	M5x65	9x105
55 - 60	M5x70	9x115
60 - 65	M5x75	
65 - 70	M5x80	9x120
70 - 75	M5x85	
75 - 80	M5x90	9x130
80 - 85	M5x95	
85 - 90	M5x100	9x140
90 - 95	M5x85 + EXTENSION	
95 - 100	M5x90 + EXTENSION	9x150
100 - 105	M5x95 + EXTENSION	
105 - 110	M5x100 + EXTENSION	9x160

FEUERSCHUTZ - WECHSELGARNITUREN, FEUERSCHUTZ

FIRE PROOF - MAIN ENTRY DOOR HANDLE SETS, FIRE RESISTANT

9 mm VK - 9 mm Spindle

Türstärke mm Door thickness	Schraube Screw	Drückerstift Lever spindle
38 - 42	M5x50	
43 - 47	M5x55	9x64
48 - 52	M5x60	
50 - 55	M5x65	9x72
55 - 60	M5x70	
60 - 65	M5x75	9x80
65 - 70	M5x80	
70 - 75	M5x85	9x90
75 - 80	M5x90	
80 - 85	M5x95	9x100
85 - 90	M5x100	
90 - 95	M5x80 + EXTENSION	9x110
95 - 100	M5x85 + EXTENSION	
100 - 105	M5x90 + EXTENSION	9x120
105 - 110	M5x95 + EXTENSION	
110 - 115	M5x100 + EXTENSION	9x130
115 - 120	M5x100 + EXTENSION	9x140

MONTAGEANLEITUNG

MOUNTING INSTRUCTIONS

FEUERSCHUTZ - GF2 / GF3 / AC3, PZ 72MM

FIRE PROOF - GF2 / GF3 / AC3, PZ 72MM

9 mm VK - 9 mm Spindle

Türstärke mm Door thickness	Schraube Screw	Drückerstift Lever spindle
38 - 52	2 x M8x50	1 x M6x50
		1 x M6x60
53 - 68	2 x M8x65	1 x M6x65
		1 x M6x75
68 - 82	2 x M8x80	1 x M6x80
		1 x M6x90
83 - 98	2 x M8x95	1 x M6x95
		1 x M6x105
99 - 113	2 x M8x110	1 x M6x110
		1 x M6x120
114 - 128	2 x M8x125	1 x M6x125
		1 x M6x135

MONTAGEANLEITUNG

MOUNTING INSTRUCTIONS

SCHUTZGARNITUREN - GF1 SYSTEM

SECURITY SETS - GF1 SYSTEM

MONTAGEANLEITUNG FÜR SCHUTZBESCHLÄGE

AUSSENSCHILD/INNENROSETTE

INSTALLATION INSTRUCTIONS FOR SECURITY FITTINGS OUTER SHIELD/INNER ROSETTE



1. Hinweis:

- Von beiden Seiten der Türe bohren und Bohrspäne entfernen
- Für die gewerbliche Montage von JATEC-Beschlägen empfehlen wir die JATEC-Bohrschablone Art.-Nr. 371CDJ00**4C***.

2 - 3. Montage:

- Bilder 2-3
- Das Schild "A" positionieren
- Die Schrauben "V" verschrauben
- Die Rosettenabdeckung Abdeckung einbauen
- Den Drücker "M" verschließen, durch Verschrauben der Madenschraube "G".

PFLEGEHINWEISE:

Grundsätzlich empfehlen wir, die Beschläge mit einem weichen Tuch trocken zu wischen. Bitte vermeiden Sie den Einsatz von Reinigungsmitteln, die Salzsäure, Ameisensäure, Essigsäure, phosphor- oder chlorbleichlaugehaltige Substanzen enthalten, ebenso wie abrasive Scheuermittel und Kratzschwämme. Ein Fensterleder erledigt die Feuchtreinigung und ein Poliertuch sorgt für ungetrübten Glanz.

1. Indication:

- Drill and remove bore chips from both sides of the door
- For a professional assembling of JADO products we suggest the drilling template Art.-No. 371CDJ00**4C***.

2-3. Mounting:

- Pictures 2-3
- Place the plate "A"
- Tighten screws "V"
- Apply rosettes cover "R"
- Tighten handle "M" while fastening the grub screw "G"

CARE INSTRUCTIONS:

As a general rule, we recommend wiping the fitting dry with a soft cloth.

Please avoid using cleaning agents which contain hydrochloric acid, formic acid, acetic acid, phosphoric or chlorine bleaching substances. Also avoid abrasive cleaners and scouring pads.

The chamois leather for windows allows a wet cleaning and a lint-free rag maintains unclouded the lucidity.

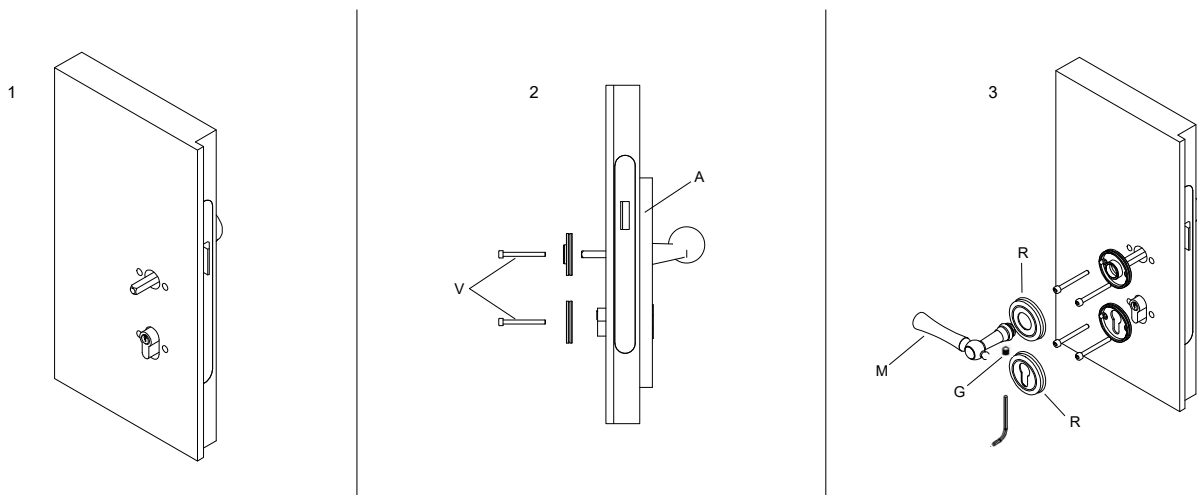

MONTAGEANLEITUNG

MOUNTING INSTRUCTIONS

SCHUTZGARNITUREN - GF2/GF3/AC3

SECURITY SETS - GF2/GF3/AC3

MONTAGEANLEITUNG FÜR SCHUTZBESCHLÄGE

AUSSENSCHILD/INNENROSETTE

INSTALLATION INSTRUCTIONS FOR SECURITY FITTINGS OUTER SHIELD/INNER ROSETTE



1. Hinweis:

- Von beiden Seiten der Türe bohren und Bohrspäne entfernen
- Für die gewerbliche Montage von Beschlägen empfehlen wir die Bohrschablone Art.-Nr. 371CDJ00**4C***.

2. Montage:

- Das Schild "A" positionieren
- Die Schrauben "V" verschrauben

3. Montage:

- Das Schild "B" positionieren
- Die Nutmutter "I" mit dem geeigneten Schlüssel "C" verschrauben

4. Montage:

- Den Drücker "M" verschließen, durch Verschrauben der Madenschraube "G".

1. Indication:

- Drill and remove bore chips from both sides of the door
- For a professional assembling of products we suggest the drilling template Art.-No. 371CDJ00**4C***.

2. Mounting:

- Place the plate "A"
- Tighten screws "V"

3. Mounting:

- Place the plate "B"
- Tighten the slotted nut "I" with the specific key "C"

4. Mounting:

- Tighten handle „M“ while fastening the grub screw "G"

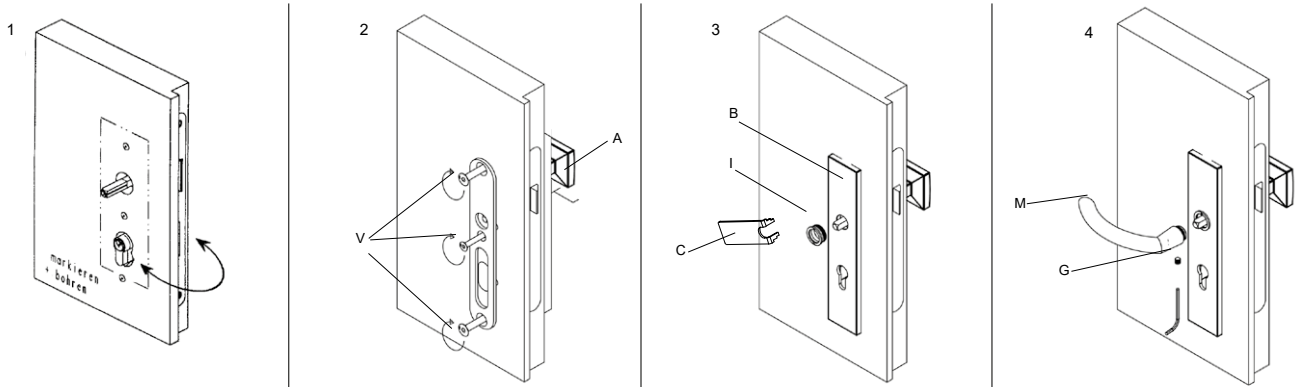

PFLEGEHINWEISE

Grundsätzlich empfehlen wir, die Beschläge mit einem weichen Tuch trocken zu wischen. Bitte vermeiden Sie den Einsatz von Reinigungsmitteln, die Salzsäure, Ameisensäure, Essigsäure, phosphor- oder chlorbleichlaugehaltige Substanzen enthalten, ebenso wie abrasive Scheuermittel und Kratzschwämme. Ein Fensterleder erledigt die Feuchtreinigung und ein Poliertuch sorgt für ungetrübbten Glanz.

CARE INSTRUCTIONS:

As a general rule, we recommend wiping the fitting dry with a soft cloth. Please avoid using cleaning agents which contain hydrochloric acid, formic acid, acetic acid, phosphoric or chlorine bleaching substances. Also avoid abrasive cleaners and scouring pads. The chamois leather for windows allows a wet cleaning and a lint-free rag maintains unclouded the lucidity.

Zylinderüberstand in Kern und Kammer:
For protruding cylinders:



10-15 mm

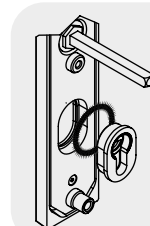

7 - 10 mm:
Benutzen Sie das Schild bitte so, wie es geliefert wurde

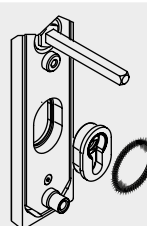

bis 12 mm:

Demontieren Sie den Kernziehschutz und nehmen Sie den schwarzen Ring heraus. Nun setzen Sie den Kernziehschutz wieder ein und positionieren den schwarzen Ring hinter dem Kernziehschutz



7-12 mm

MONTAGEANLEITUNG

MOUNTING INSTRUCTIONS

SCHUTZGARNITUREN - GF1, PZ 72MM

SECURITY SETS - GF1, PZ 72MM

Türstärke mm Door thickness	Schraube Screw	Drückerstift Lever spindle
38 - 40	4 x M5x45	1 x Stift 8x68
40 - 45	4 x M5x50	
45 - 50	4 x M5x55	
50 - 55	4 x M5x60	1 x Stift 8x78
55 - 60	4 x M5x65	
60 - 65	4 x M5x70	1 x Stift 8x88
65 - 70	4 x M5x75	
70 - 75	4 x M5x80	1 x Stift 8x98
75 - 80	4 x M5x85	
80 - 85	4 x M5x90	1 x Stift 8x108
85 - 90	4 x M5x95	
90 - 95	4 x M5x100	1 x Stift 8x118
95 - 100	4 x M5x105	
100 - 105	4 x M5x110	1 x Stift 8x128
105 - 110	4 x M5x115	
110 - 115	4 x M5x120	1 x Stift 8x138
115 - 120	4 x M5x125	

SCHUTZGARNITUREN - GF1, PZ 92MM

SECURITY SETS - GF1, PZ 92MM

Türstärke mm Door thickness	Schraube Screw	Drückerstift Lever spindle
38 - 40	4 x M5x45	1 x Stift 8/10x68
40 - 45	4 x M5x50	
45 - 50	4 x M5x55	
50 - 55	4 x M5x60	1 x Stift 8/10x78
55 - 60	4 x M5x65	
60 - 65	4 x M5x70	1 x Stift 8/10x88
65 - 70	4 x M5x75	
70 - 75	4 x M5x80	1 x Stift 8/10x98
75 - 80	4 x M5x85	
80 - 85	4 x M5x90	1 x Stift 8/10x108
85 - 90	4 x M5x95	
90 - 95	4 x M5x100	1 x Stift 8/10x118
95 - 100	4 x M5x105	
100 - 105	4 x M5x110	1 x Stift 8/10x128
105 - 110	4 x M5x115	
110 - 115	4 x M5x120	1 x Stift 8/10x138
115 - 120	4 x M5x125	

MONTAGEANLEITUNG

MOUNTING INSTRUCTIONS

SCHUTZGARNITUREN - GF12 / GF3 / AC3, PZ 72MM

SECURITY SETS - GF2 / GF3 / AC3, PZ 72MM

Türstärke mm Door thickness	Schraube Screw	Drückerstift Lever spindle		
38 - 52	2 x M8x50	1 x M6x50	1 x Stift 8x68	STANDARD TS DT STANDARD
		1 x M6x60		
53 - 68	2 x M8x65	1 x M6x65	1 x Stift 8x88	
		1 x M6x75		
68 - 82	2 x M8x80	1 x M6x80	1 x Stift 8x98	
		1 x M6x90		
83 - 98	2 x M8x95	1 x M6x95	1 x Stift 8x118	
		1 x M6x105		
99 - 113	2 x M8x110	1 x M6x110	1 x Stift 8x133	
		1 x M6x120		
114 - 128	2 x M8x125	1 x M6x125	1 x Stift 8x148	
		1 x M6x135		

SCHUTZGARNITUREN - GF12 / GF3 / AC3, PZ 92MM

SECURITY SETS - GF2 / GF3 / AC3, PZ 92MM

Türstärke mm Door thickness	Schraube Screw	Drückerstift Lever spindle		
38 - 52	2 x M8x50	1 x M6x50	1 x Stift 8/10x68	
		1 x M6x60		
53 - 68	2 x M8x65	1 x M6x65	1 x Stift 8/10x88	
		1 x M6x75		
68 - 82	2 x M8x80	1 x M6x80	1 x Stift 8/10x98	STANDARD TS DT STANDARD
		1 x M6x90		
83 - 98	2 x M8x95	1 x M6x95	1 x Stift 8/10x118	
		1 x M6x105		
99 - 113	2 x M8x110	1 x M6x110	1 x Stift 8/10x133	
		1 x M6x120		
114 - 128	2 x M8x125	1 x M6x125	1 x Stift 8/10x148	
		1 x M6x135		

SCHUTZGARNITUREN - GF5

SECURITY SETS - GF5

Türstärke mm Door thickness	Schraube Screw
38 - 50	2 x M5x45
	2 x M5x50
	2 x M5x55
50 - 60	2 x M5x60
	2 x M5x65
60 - 70	2 x M5x70
	2 x M5x75
70 - 80	2 x M5x80
	2 x M5x85
80 - 90	2 x M5x90
	2 x M5x95
90 - 100	2 x M5x100
	2 x M5x105
100 - 110	2 x M5x110
	2 x M5x115
110 - 120	2 x M5x120
	2 x M5x125

MONTAGEANLEITUNG

MOUNTING INSTRUCTIONS

FESTER KNOPF

FIXED KNOB

FESTER KNOPF AUF ROSETTE

FIXED KNOB ON ROSE

Mit Befestigungsplatte und Holzschrauben

Fixing plate and wooden screws fixing

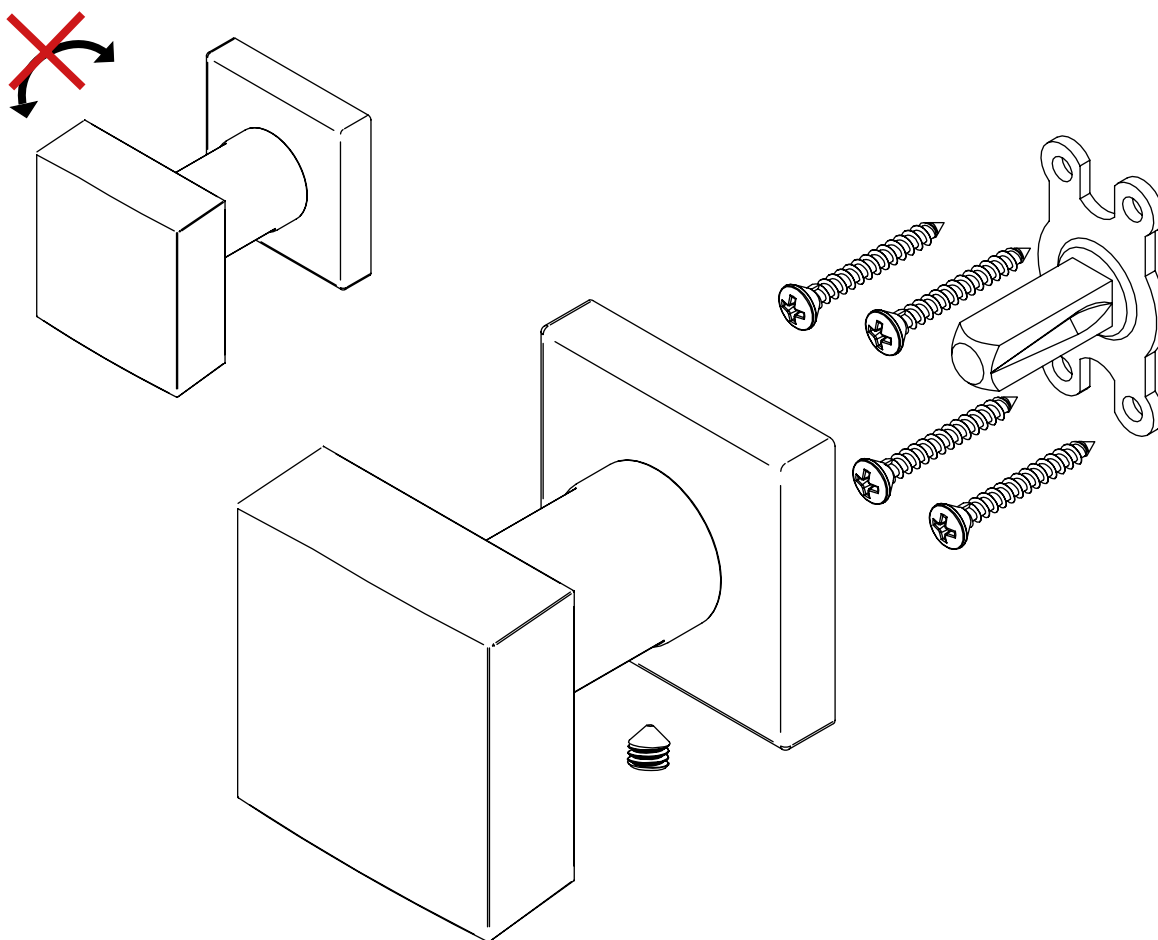

MONTAGEANLEITUNG

MOUNTING INSTRUCTIONS

HEBE/SCHIEBETÜR BESCHLÄGE

PULL HANDLES FOR LIFT AND SLIDING DOORS

CHARAKTERISTIK DER ZUGGRIFFE FÜR SCHIEBETÜREN

CHARACTERISTIC OF THE PULL HANDLES FOR SLIDING DOOR

- Verwendbar für Achsabstand 63 mm und 80 mm
- Mechanismus mit 2 Positionen
- Vierkantstift \varnothing 10 mm
- Double center distance 80 mm and 63 mm
- Mechanism with 2 releases
- Square \varnothing 10 mm

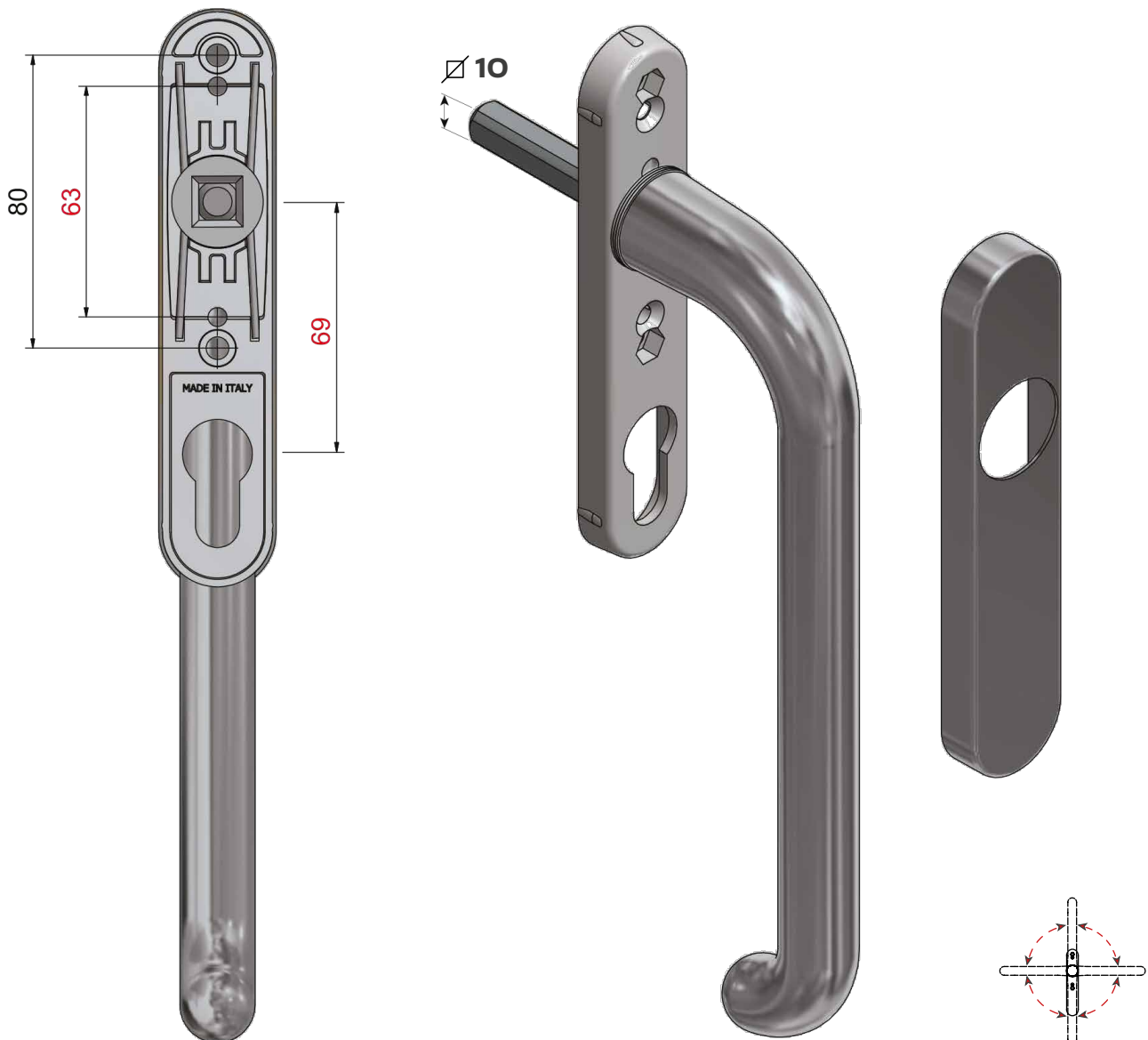

MECHANISMUS MIT 4 POSITIONEN AUF ANFRAGE

ON REQUEST MECHANISM WITH 4 RELEASES

Mechanismus mit 4 Positionen und Vierkant \varnothing 7 mm, oder \varnothing 8 mm auf Anfrage.

4 positions metal mechanism available on request with \varnothing 7 mm or \varnothing 8 mm spindle

CHARAKTERISTIK DER ZUGGRIFFE FÜR SCHIEBETÜREN

CHARACTERISTIC OF THE PULL HANDLES FOOR SLIDING DOOR

- Verwendbar für Achsabstand 63 mm und 80 mm
- Mechanismus mit 2 Positionen
- Vierkantstift \sphericalangle 10 mm

- Double center distance 80 mm and 63 mm
- Mechanism with 2 releases
- Square \sphericalangle 10 mm

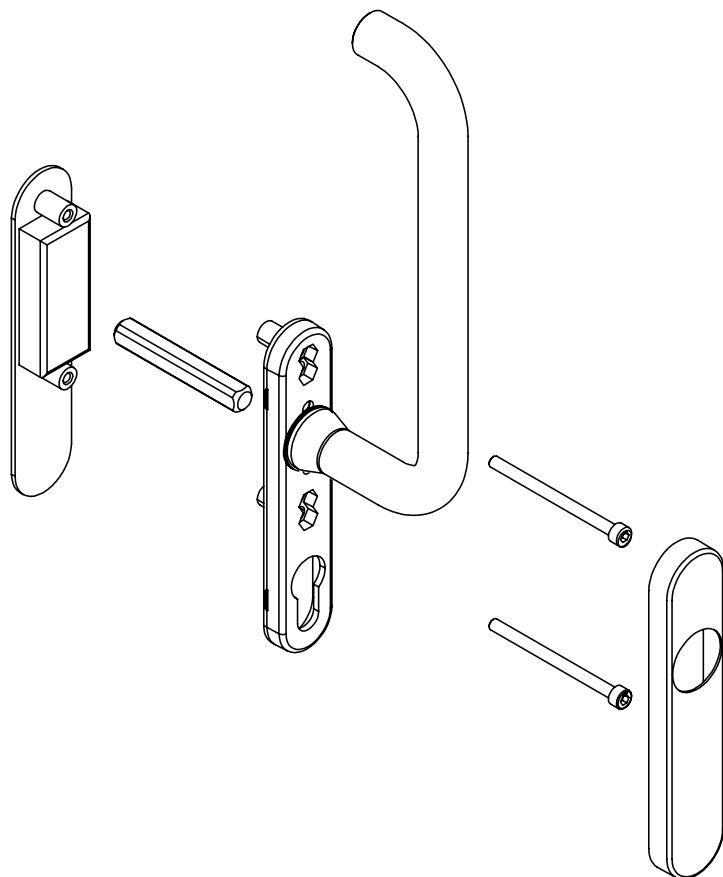

FRÄSUNG - MILLINGS

SCHILDSEITE
FLUSH PULL PLATE SIDE

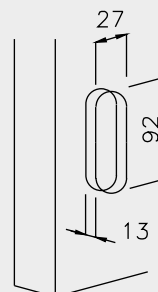

GRIFFSEITE
PULL HANDLE SIDE

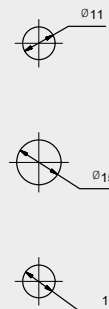

STANDARD TÜRSTÄRKE

STANDARD DOOR THICKNESS

58-68

Standard Türstärke bei Hebe/
Schiebetürgriffen

Standard door thickness
for lift and slide single pull
handle

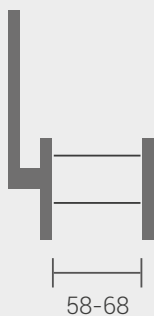

75

Standard Türstärke bei Paar
Hebe/Schiebetürgriffen

Standard door thickness for
lift and slide pair pull handles

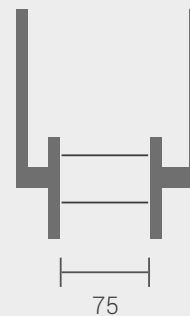

MONTAGEANLEITUNG

MOUNTING INSTRUCTIONS

INKLUSIVE BEFESTIGUNGSPAKET
INCLUDED FIXING PACK



Befestigung für Holz, Aluminium, PVC und Glas.

Fixing for timber, aluminium, PVC and glass.

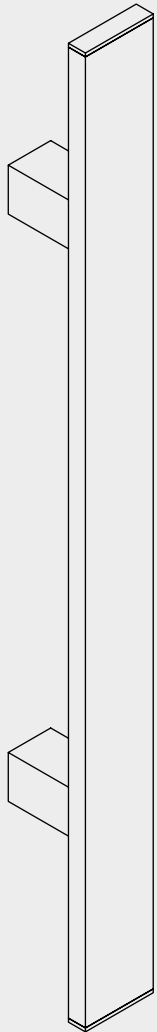

Stossgriff.
Pull handle.

A

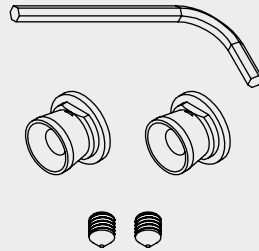

Befestigungsbuchsen,
Madenschrauben,
Inbusschlüssel,
Madenschraubenkappen.
*Fixing bushes, grub screws,
allen key, grub screw caps.*



D

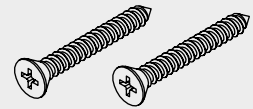

2x 4,8x38 mm
selbstschneidende
Schrauben.
*2x 4,8x38 mm self-threading
screws.*



B

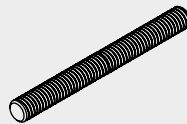

1x durchgehende Schraube
M8x95 mm.
1x through bolt M8x95 mm.

C

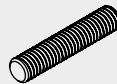

1 Tronkonus M8x50 mm.
1x through bolt M8x50 mm.

E

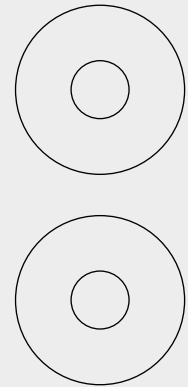

Unterlegscheiben aus Nylon.
Nylon washers.

EINZELBEFESTIGUNG

SINGLE FIXING

Das A+D-Zubehör eignet sich für die einseitige Befestigung des Zuggriffs an Beschlägen aus Holz, Aluminium und PVC. (Geprüft für 100Kgs)

A + D accessories are suitable for the single face fixing of the pull handle on timber, aluminium and PVC hardware. (Tested for 100Kgs)

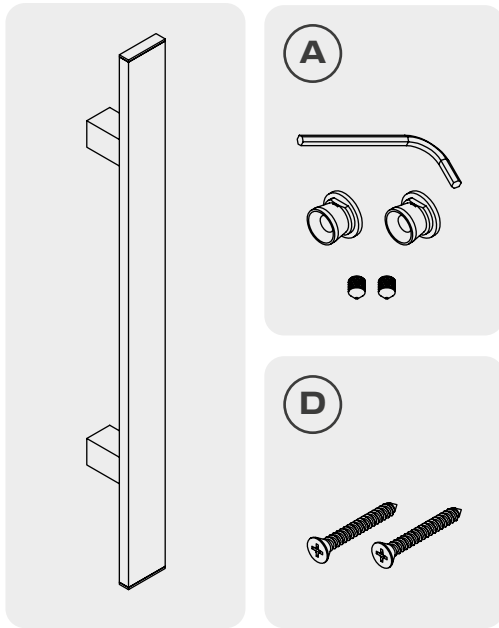

EINZELBEFESTIGUNG HOLZ - ALUMINIUM - PVC

SINGLE FIXING TIMBER - ALUMINIUM - PVC

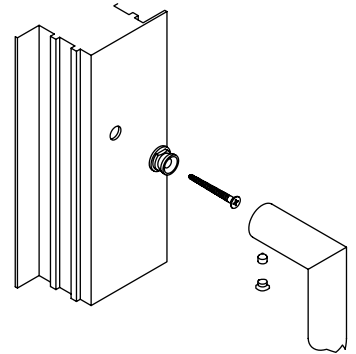
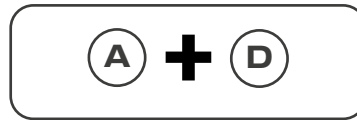

PAARBEBEFESTIGUNG

PAIR FIXING

Durch den Kauf von 2x Einheiten von Einzelziehgriffen wird die richtige Anzahl von Zubehör für die Befestigung von 1 Paar geliefert.

By purchasing 2x units of single pull handles, the correct number of accessories for 1 pair fixing is provided.

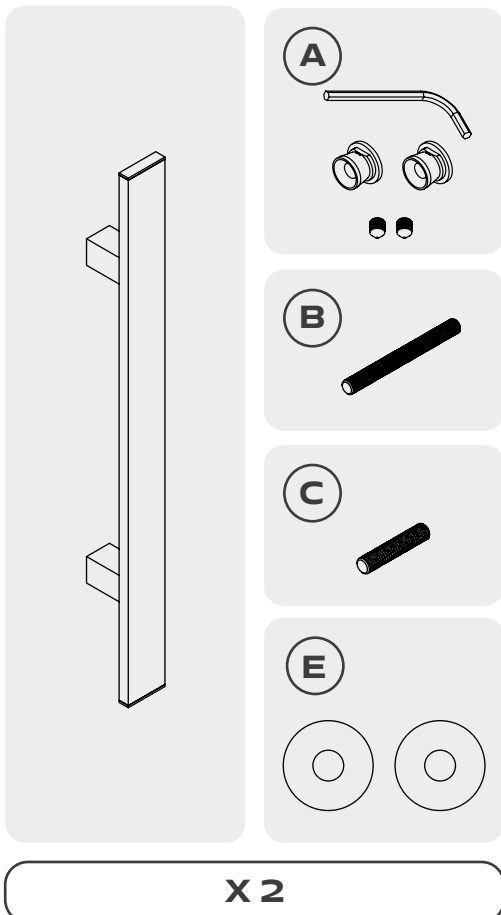

BEFESTIGUNGSPAAR HOLZ - ALUMINIUM - PVC

PAIR FIXING TIMBER - ALUMINIUM - PVC

A + D Zubehör (x2) sind für die Rücken-an-Rücken-Befestigung von 1 Paar Ziehgriffen auf Holz-, Aluminium- und PVC-Beschlägen geeignet.

A + D accessories (x2) are suitable for the back to back fixing of 1 pair pull handle, on timber, aluminium and PVC hardware.

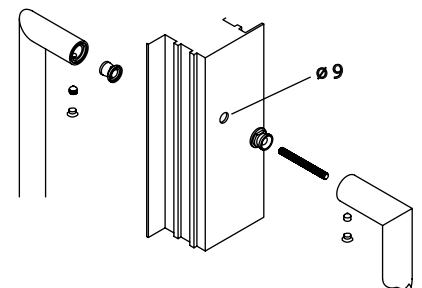
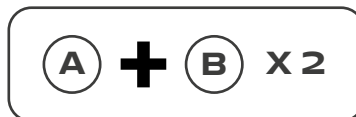

FISSAGGIO ACCOPIATO VETRO

PAIR FIXING GLASS

Die Zubehörteile A + C + E (x2) sind für die paarweise Befestigung an Glasscheiben geeignet.

A + C + E (x2) accessories are suitable for pair fixing on glass panels.

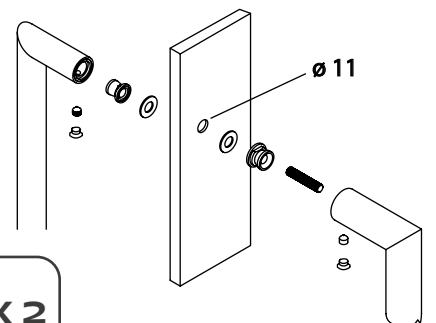
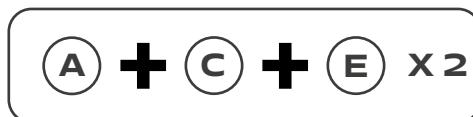

MONTAGEANLEITUNG

MOUNTING INSTRUCTIONS

GANZGLASTÜRBECHLÄGE

GLASS DOOR

AMBIENTE PLUS

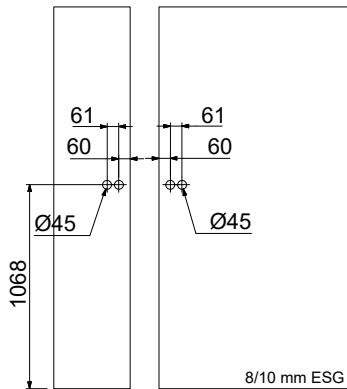
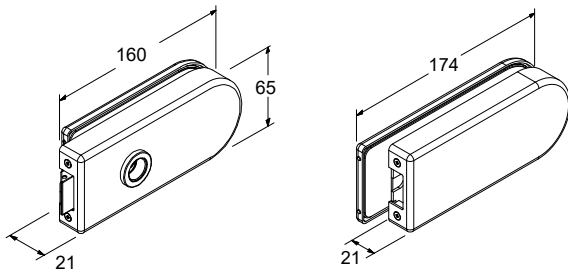

Bohrungen Gegenkasten
Drill for strike box

Bohrungen Schlosskasten
Drill for lock

AMBITION PLUS

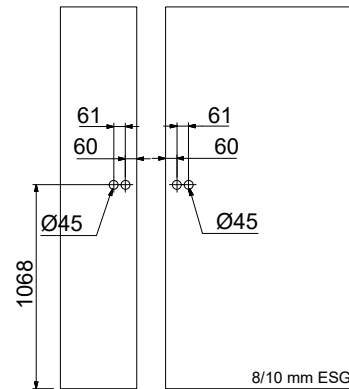
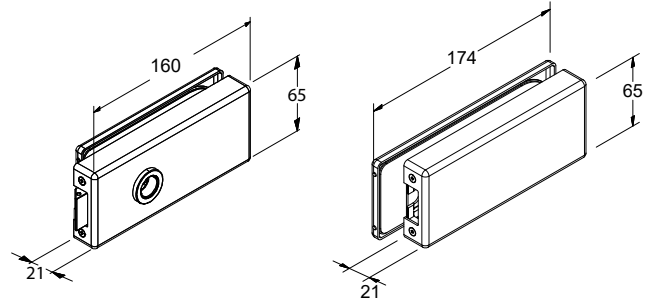

Bohrungen Gegenkasten
Drill for strike box

Bohrungen Schlosskasten
Drill for lock

AVANTGARDE PLUS

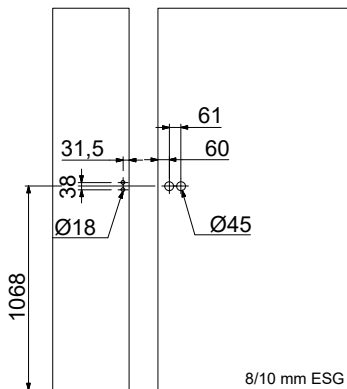
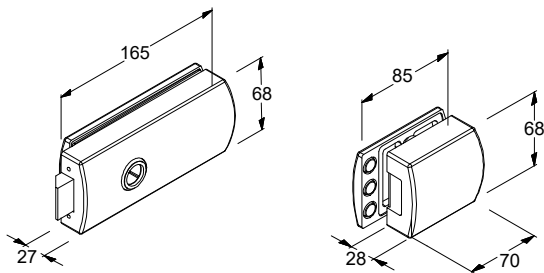

Bohrungen Gegenkasten
Drill for strike box

Bohrungen Schlosskasten
Drill for lock

COMPACT SQUARE

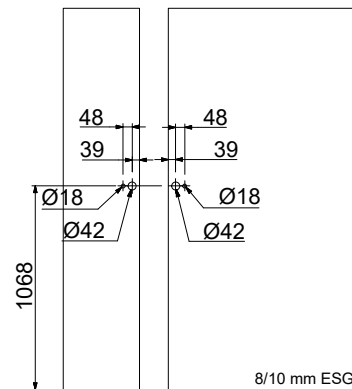
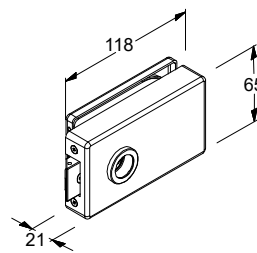

Bohrungen Gegenkasten
Drill for strike box

Bohrungen Schlosskasten
Drill for lock

TÜRBECHLÄGE FÜR GLASTÜREN/BÄNDERPAARE

DOOR HARDWARE FOR GLASS DOORS/HINGES

Glastürcbänder geeignet für 8 mm Glastürstärke

Glass hinges suitable for 8 mm glass doors

2 - TEILIG (592CE)

Montageanleitung für 2teiliges Glastürband

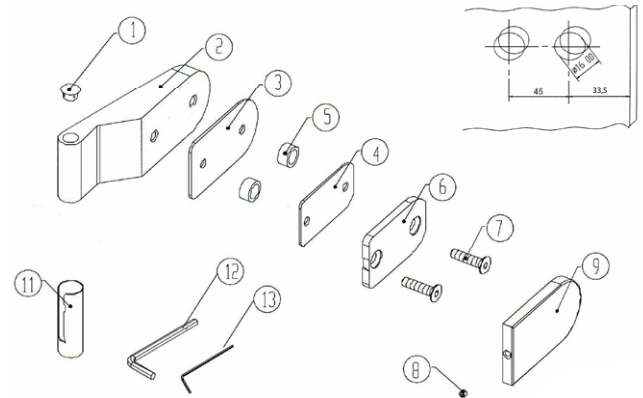
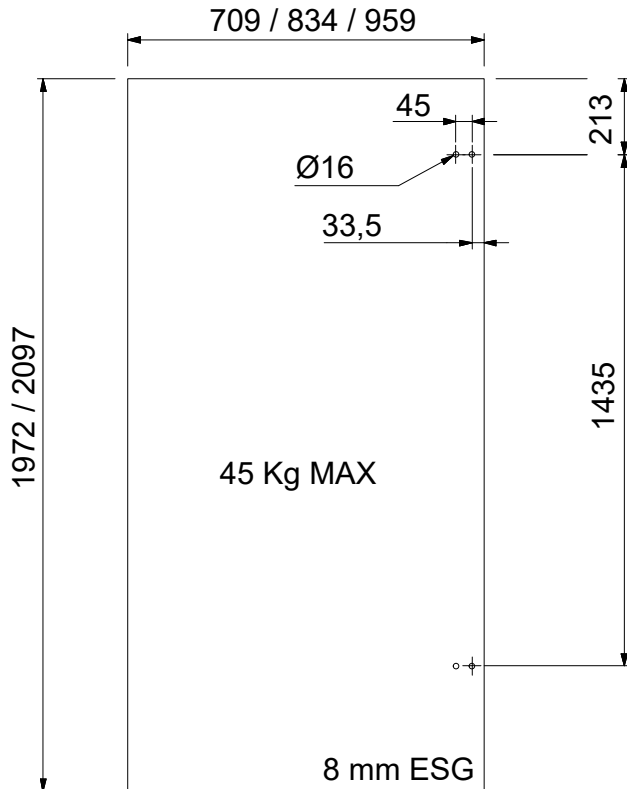

Demontieren des Glastürbandes

1. Schraube (8) mit dem mitgelieferten Innenschkantschlüssel (13) durch links drehen lösen und die Abdeckung (9) entfernen.
2. Schrauben (7) mit dem mitgelieferten Innenschkantschlüssel (12) durch links drehen lösen und die Teile (6-4-5-) von dem Körper (2) entfernen.
3. Die Zwischengummis des Bandes und der Druckplatte sind fettfrei zu machen (handelsüblicher Glasreiniger).

Montage des Glastürbandes

1. Die Klemmflächen für die Bänder sind auf dem Glas fettfrei zu machen (handelsüblicher Glasreiniger)
2. Bandteil (2) über den Bolzen des montierten Rahmenteils in der Türzarge schieben.
3. Ganzglasflügel im Türrahmen auf 7mm Platten stellen (untere Türluft) und seitlich ausrichten.
4. Kunststoffschlauchabschnitte (5) in die Glasbohrungen stecken.
5. Von der Gegenseite ist die Klemmplatte (6) mit der Dichtung (4) mittels der Schrauben (7) mit dem Bandteil (2) zu verbinden. **Achtung: Bitte das Band mit 2 mm "Vorspannung nach oben" montieren.**

Die Schrauben (7) sind mit dem Drehmomentschlüssel, eingestellt auf 12 Nm festzuziehen.

6. Die Abdeckung (9) über die Klemmplatte (6) einhängen und mit der Schraube (8) festziehen.
7. Verschlusskappe (1) von oben in das Bandteil (2) drücken.
8. Hülsen (11) über das Rahmenteil schieben.

TÜRBSCHLÄGE FÜR GLASTÜREN/BÄNDERPAARE

DOOR HARDWARE FOR GLASS DOORS/HINGES

Glastürcbänder geeignet für 8 mm Glastürstärke

Glass hinges suitable for 8 mm glass doors

3 - TELING (493CEP39)

Montageanleitung für 2teiliges Glastürband

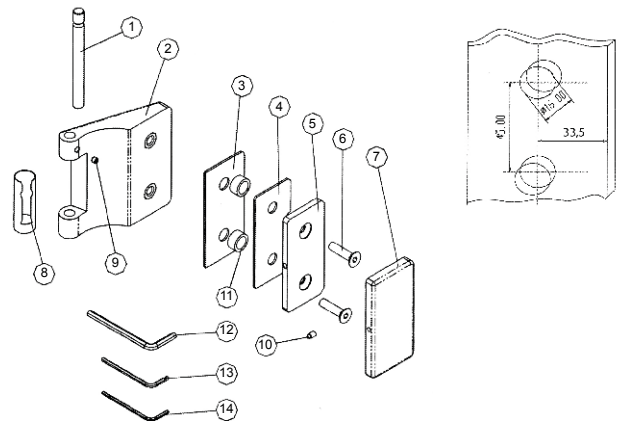
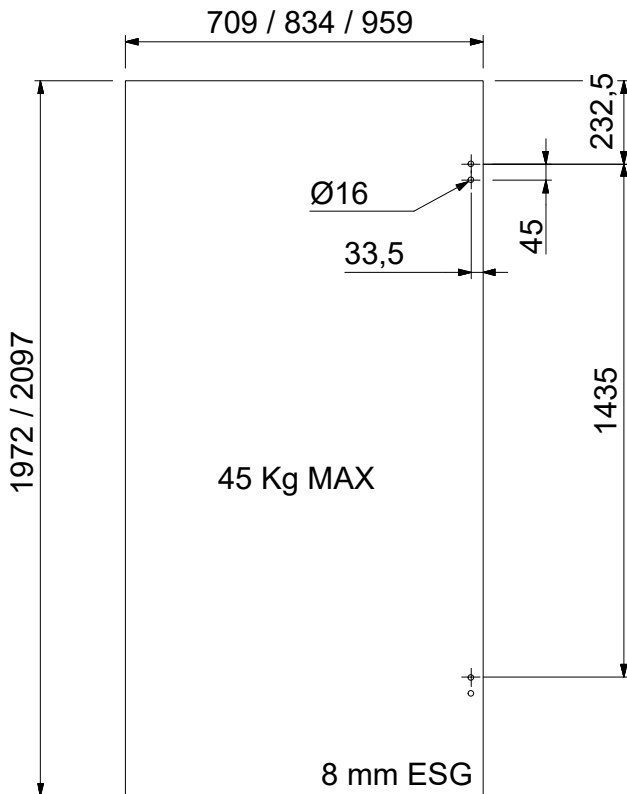

Demontieren des Glastürbandes

1. Stahlbolzen (1) durch links drehen der Schraube (9) mit dem mitgelieferten Innensechskantschlüssel (13) entfernen
2. Schraube (10) durch rechts drehen mit dem mitgelieferten Innensechskantschlüssel (14) in die Gegenplatte (5) einschrauben und die Abdeckung (7) entfernen.
3. Schrauben (6) sind durch links drehen aus Körper (2) mit dem mitgelieferten Innensechskantschlüssel (12) zu entfernen.

Montage des Glastürbandes

1. Die Klemmflächen für die Bänder sind auf Glas fettfrei zu machen (handelsüblicher Glasreiniger).
2. Entsprechende Rahmenteile (**nicht im Lieferumfang enthalten**) in die Türzarge stecken und befestigen.
3. Hülse (8) über den Bolzen Vom Rahmenteil schieben.
4. Bandteil (2) über die Hülse (8) und Bolzen des Rahmenteils schieben, Stahlbolzen (1) von unten in das Bandteil (2) schieben und durch rechts drehen der Schraube (9) mittels Innensechskantschlüssel (13) befestigen.
5. Ganzglasflügel im Türrahmen auf 7mm Platten setzen (untere Türluft) und seitlich ausrichten.
6. Schlauchabschnitte (11) sind in die Bohrlöcher der Glastür zu stecken.
7. Von der Gegenplatte die Gegenplatten (4 und 5) mit der Schraube (10) nach innen mittels der Schrauben (6) nun montieren.

Die Schrauben (6) sind mit einem Drehmomentschlüssel eingestellt auf 12Nm fastzuziehen.

8. Die Abdeckung (7) ist nun mit dem Schraubloch nach innen über die Gegenplatte (5) zu stecken und durch links drehen der Schraube (10) zu befestigen.

TÜRBSCHLÄGE FÜR GLASTÜREN/BÄNDERPAARE

DOOR HARDWARE FOR GLASS DOORS/HINGES

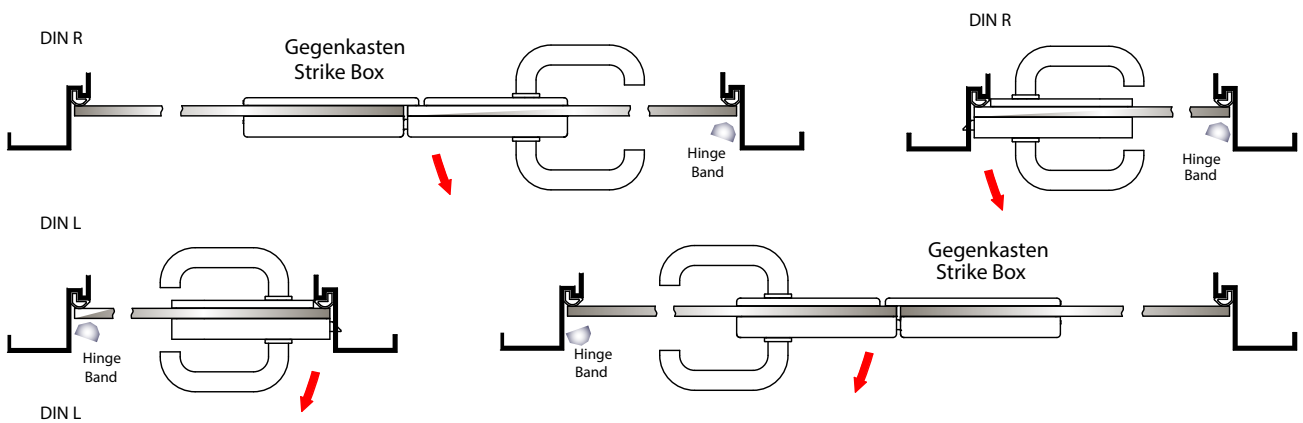
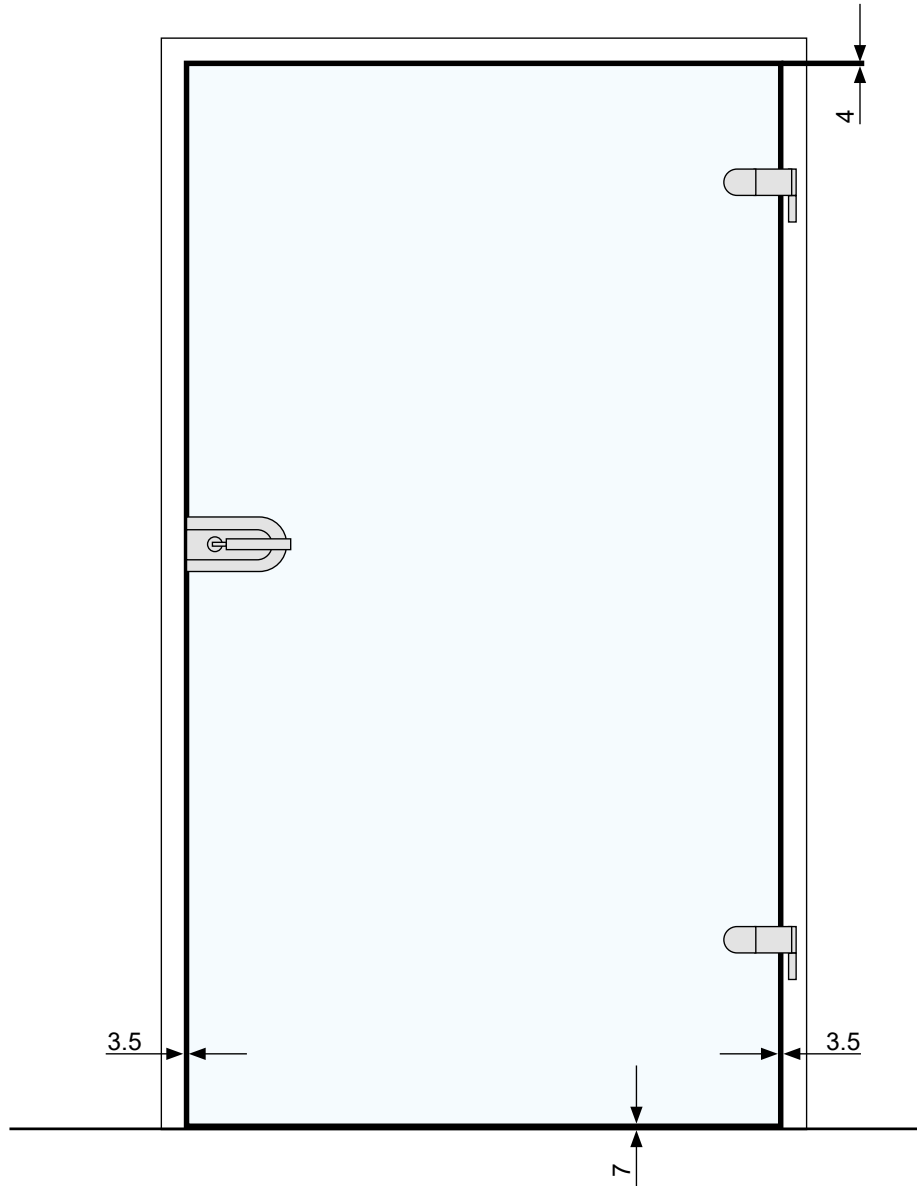

JATEC PRODUKTHAFTUNG

PRODUCT LIABILITY



Abbildung 1:
Nicht gewaltsam oder mit Hilfswerk-zeugen (z. B. Zangen oder Aufsatz-teilen) bedienen.

Figure 1:
Do not use violent force or ancillary tools (e.g. pincers or sockets)

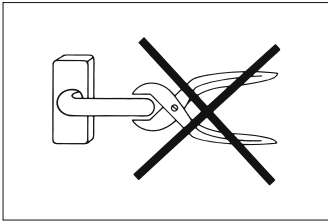

Abbildung 6:
Keine Fremd- und/oder nicht bestimmungsgemäßen Gegenstände einbringen (z. B. Stifte von Fremdherstellern oder die Kombination von Fremdlochteilen mit JATEC-Originalteilen)

Figure 6:
Do not use any inappropriate tools or tools which do not belong to the fitting (e. g. pins made by other manufacturers or a combination of other screw components and original JATEC components)

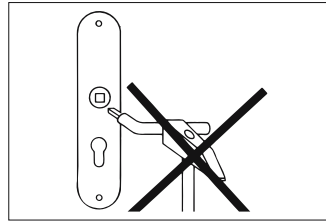

Abbildung 2:

Figure 2:

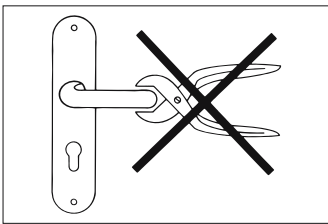

Abbildung 7:
Keine Zusatzlasten (Halte- oder Abstützkräfte) einbringen (z. B. Unterstellen eines Gegenstandes unter einen Türgriff, um eine Blockierung der Tür zu erreichen).

Figure 7:
Do not insert any additional objects (for holding or securing), e. g. by putting an object under the door handle in order to block the door.

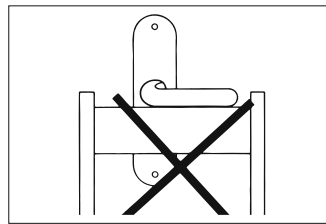

Abbildung 3:

Figure 3:

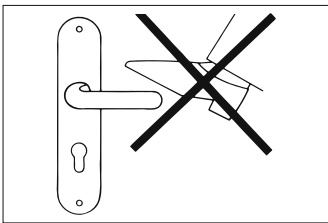

Abbildung 8:
Einwirkungen von Kräften, die über die normale Handkraft hinausgehen, vermeiden.

Figure 8:
Avoid the use of all force greater than normal manual force.

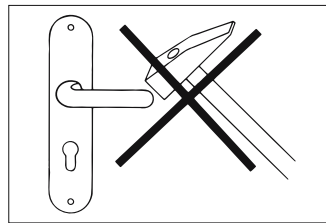

Abbildung 4:

Figure 4:

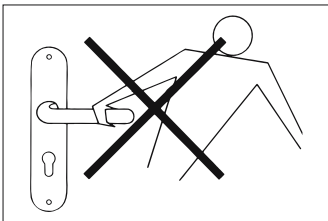

Abbildung 9:
Keine scharfen Gegenstände, die die Oberfläche beschädigen können, anwenden.

Figure 9:
Do not use any sharp objects which might damage the surface

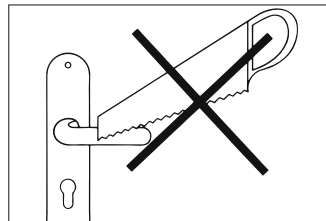

Abbildung 5:

Figure 5:

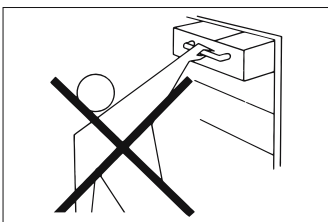

Abbildung 10:
Garnituren nicht mit starken Säuren oder Alkalien behandeln. Nur Reinigungsmittel verwenden, die keine korrosionsfördernden Bestandteile enthalten.

Figure 10:
Do not use strong acids or alkalis on the fittings. Only use cleansers which do not contain corrosive ingredients

Das „Produkthaftungsgesetz“ vom 1.1.1990 regelt die Haftung des Herstellers für seine Produkte. Gemäß dieser Verordnung (§4 ProdHafG) bitten wir Sie, die nachfolgenden Informationen über Türgriffgarnituren (Türdrückergarnituren), Schilder, Rosetten und Fenstergriffe, Möbelbeschläge (Griffe und Knöpfe), Hut- und Mantelhaken, Einlaßgriffe und Relingsysteme zu beachten. Die Nichtbeachtung entbindet uns von unserer Haftungspflicht. Da der Hersteller seine Produkte leistungsbezogen definieren sollte (Instruktions- und Hinweispflichten), geben wir zur Beachtung nachfolgende Informationen:

1. Produktinformation und bestimmungsgemäße Verwendung

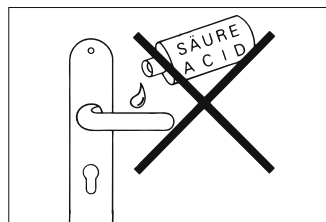
Türgriffgarnituren (Türdrückergarnituren), Schilder, Rosetten, Fenstergriffe, Möbelbeschläge (Griffe und Knöpfe), Hut- und Mantelhaken, Einlaßgriffe und Relingsysteme im Sinne dieser Definition sind Bauteile, die im allgemeinen austauschbar sind und deren Einsatz zusammen mit ergänzenden Schloß- und Beschlagteilen (Türschlösser, Möbelschlösser, Zylinder und Fensterbeschläge) erfolgt. Diese Produkte sind vorzugsweise Bedienungshandhaben, mit deren Hilfe Öffnungs- und Schließbewegungen und/oder Sperrvorgänge an Türen, Fenstertüren und Fensterelementen im Hoch-/ Wohnungsbau vorgenommen werden können. Türgriffgarnituren (Türdrückergarnituren, Schilder, Rosetten und Fenstergriffe) können nur dann vorbehaltlos mit den ergänzenden Schloß- und Beschlagteilen in Türen, Fenstertüren und Fensterelementen eingebaut werden, wenn sie maßlich mit den Festlegungen von DIN 18255 und 18257 und 18273 übereinstimmen.

Mitgelieferte Befestigungsmittel sind unbedingt zu verwenden. Dies gilt für Befestigungsmittel:

a) vom Hersteller,

b) für alle Befestigungsmittel bzw. deren Vorschriften des zum Produkt gehörenden Beschlages (Fenstergriffe: Schrauben vom Dreh/Kipp Beschlaghersteller), (RAL-Schutzbeschläge; hochfeste Gewindeschrauben vom Beschlaghersteller).

Produkte, die in aggressiver, korrosionsfördernder Umgebung eingesetzt werden, sind Sonderbeschläge; ihr Einsatz (ihre Verwendung) sollte nur nach vorheriger Rücksprache mit dem Hersteller erfolgen.

Zwingende Rechtsvorschriften müssen beachtet werden, zum Beispiel bei Feuerschutzabschlüssen und deren Fluchrichtung, wenn es sich hierbei um Wechselgarnituren handelt.

2. Fehlgebrauch (unsachgemäße oder bestimmungswidrige Handhabung)

Ein Fehlgebrauch – als die nicht bestimmungsgemäße Produktnutzung – von Türgriffgarnituren (Türdrückergarnituren) und Fenstergriffen liegt insbesondere dann vor, wenn:

die Bedienung mit Hilfswerkzeugen erfolgt (z.B. Zangen oder Aufsatzstücken), siehe Abb. 1,

die Einbringung von Zusatzlasten (Halte- und Abstützkräfte) vorliegt (z.B. das Unterstellen eines Gegenstandes unter einen Türgriff, um eine Blockierung der Tür zu erreichen), siehe Abb. 4, 5, 6 u. 7, über die normale Handkraft hinausgehende Kräfte auf den Griff einwirken (z.B. der Versuch, ein Blockieren des Türbeschlages mit erhöhtem Kraftaufwand zu beseitigen), siehe Abb. 8,

die Einbringung von Fremd- und/oder nicht bestimmungsgemäßen Gegenständen erfolgt (z.B. Stifte von Fremdherstellern oder die Kombination von Fremdlochteilen mit unseren Originalteilen), siehe Abb. 3,

Ein- bzw. Angriffe erfolgen, welche die Funktion beeinflussen (z.B. Gewaltangriffe mit Hilfswerkzeugen), siehe Abb. 2,

mit scharfen Gegenständen die Oberfläche beschädigt wird, siehe Abb. 9.

3. Die Produktleistung

Richtungsweisend sind bei Türgriffgarnituren (Türdrückergarnituren) die DIN-Normen 18255, 18257 sowie 18273. Der Inhalt der Normen ist sinngemäß auch auf andere Beschläge anzuwenden. Die Produktleistungen von Fenstergriffen sind in RAL-Güte-Richtlinien festgelegt.

Über diese Unterlagen hinausgehende Anforderungen sind mit dem Hersteller zu vereinbaren. Die Dauer der Gebrauchstauglichkeit eines Produktes ist insbesondere abhängig von der

Bedienungshäufigkeit

Bedienungsweise

Umgebung und der Pflege.

Der Ersatz eines Produktes ist erforderlich, wenn trotz Wartung und Pflege die Funktion nicht mehr gewährleistet ist bzw. die Oberfläche Verletzungsgefahr erzeugt.

4. Die Produktwartung

Auf den sachgerechten Funktionssitz des Beschlages und der Befestigungsmittel ist zu achten!

Insbesondere bei Türgriff-Stiftverbindung sowie bei Schließzylindern für abschließbare Fenstergriffe ist jährlich eine Wartung vorzunehmen. Bei den Schließzylindern ist darauf zu achten, dass nicht verharzende Öle (sinnvoll: Graphit) verwendet werden.

Türgriffgarnituren und Fenstergriffe sind je nach Beanspruchung mit von uns empfohlenen Pflegemitteln zu behandeln. Grundsätzlich dürfen sie nicht mit starken Säuren und Alkalien behandelt werden, siehe Abb. 10.

Es ist in jedem Fall die Verschmutzung mit Mörtel und ähnlichen Materialien zu vermeiden. Es sollten nur solche Reinigungsmittel verwendet werden, die keine korrosionsfördernden Bestandteile enthalten.

5. Informations- und Instruktionspflicht

Zur Auswahl von Türgriffgarnituren

(Türdrückergarnituren und Fenstergriffe) sowie zum Einbau, zur Bedienung und zur Pflege sind:

Fachhändler gehalten, die Produktinformation und Hinweise in den Unterlagen zu beachten, insbesondere alle erforderlichen Anleitungen vom Hersteller anzufordern und an die Verarbeiter weiterzugeben.

Verarbeiter gehalten, alle Produktinformationen zu beachten und insbesondere Bedienungs- und Pflegeanleitungen von dem Hersteller anzufordern und an die Auftraggeber weiterzugeben.

6. Anwendung für artverwandte Beschläge

Die innerhalb der einzelnen Beschlagsysteme möglichen Varianten und zusätzlichen Beschläge sowie Zubehör sind hinsichtlich Produktinformation und bestimmungsgemäßer Verwendung, Fehlgebrauch, Produktleistung, Produktwartung, Informations- und Instruktionspflicht je nach zutreffenden Merkmalen sinngemäß zu behandeln.

ALLGEMEINE VERKAUFSBEDINGUNGEN

GENERAL TERMS OF SALE

- I Allgemeines Verkauf und Lieferungen erfolgen ausschließlich zu den nachstehenden Bedingungen. Sie gelten auch für alle zukünftigen Geschäfte, selbst wenn wir im Einzelfall nicht auf diese Bedingungen Bezug nehmen. Nebenabreden und Änderungen bedürfen unserer schriftlichen Bestätigung. Die Einkaufsbedingungen des Käufers werden nicht Vertragsinhalt, auch wenn wir ihnen nicht ausdrücklich widersprechen; unsere Bedingungen gelten spätestens mit der Annahme der Ware als anerkannt.
- II Preise
- 2.1 Wenn nichts anderes vereinbart ist, gelten die Preise für Lieferung ab Werk. Die Preisbasis für die einzelnen Produktgruppen ergibt sich aus unseren jeweils geltenden Preislisten und Rundschreiben. Soweit wir frachtfrei liefern, tragen wir die normale Fracht bei Paketdiensten bis zum Bestimmungsort, bei Bahnversand bis zu dem Bestimmungsort nächstgelegenen Bahnstation und bei LKW-Versand bis zum Bestimmungsort unabeladen.
- 2.2 Tritt zwischen der Auftragserteilung und dem Tag der Lieferung eine Änderung der Preisgrundlage ein, so sind wir berechtigt, die vereinbarten Preise entsprechend anzupassen, wenn zwischen Vertragschluss und vereinbartem Liefertermin mehr als 6 Wochen liegen. Dies gilt insbesondere bei einer Änderung der Kosten für Roh-, Hilfs- und Betriebsstoffe, unfertige und fertige Erzeugnisse, Personal, Verpackung, Fracht, Steuern und andere Abgaben, sowie sonstige Fertigungs-, Vertriebs- und Verwaltungskosten. Der Käufer ist zum Rücktritt nur berechtigt, wenn die Preiserhöhung dem Anstieg der allgemeinen Lebenshaltungskosten zwischen Bestellung und Lieferung nicht unerheblich übersteigt.
- 2.3 Für Aufträge, für die keine Preise vereinbart sind, berechnen wir unsere jeweils am Liefertag geltenden Preise.
- 2.4 Die Preise verstehen sich stets zuzüglich Mehrwertsteuer zum bei Lieferung geltenden Satz.
- III Zahlungsbedingungen
- 3.1 Unsere Rechnungen sind gemäß der vereinbarten Zahlungsbedingung zu begleichen. Auf verrechnete Gutschriften vergüten wir kein Skonto. Voraussetzung für die Skontogewährung ist, dass alle fälligen Beträge beglichen sind.
- 3.2 Schecks werden nur erfüllungshalber angenommen, Wechsel werden nicht akzeptiert.
- 3.3 Bei verspäteter Zahlung berechnen wir Verzugszinsen in Höhe von 10 Prozentpunkten über dem jeweiligen Basiszinssatz. Wir behalten uns vor, einen höheren Schaden geltend zu machen. Vorauszahlungen werden nicht verzinst. Spesen gleich welcher Art gehen zu Lasten des Käufers.
- 3.4 Werden nach Vertragsabschluss Umstände bekannt, die die Kreditwürdigkeit des Käufers zu mindern geeignet sind, sind wir berechtigt, sofortige Zahlung oder hinreichende Sicherheit zu verlangen oder auch ohne Verpflichtung zu Schadensersatz, vom Vertrag zurückzutreten sowie die Erfüllung noch auszuführender Aufträge zurückzustellen. Im Falle der Zahlungseinstellung oder Insolvenz des Käufers sind alle noch offenen Rechnungen sofort fällig.
- 3.5 Die Aufrechnung ist nur mit unbestrittenen oder rechtskräftig festgestellten Gegenforderungen zulässig. Die Zurückhaltung von Zahlungen wegen irgendwelcher von uns nicht anerkannten oder rechtskräftig festgestellten Gegenansprüche ist nicht statthaft, ebensowenig die Aufrechnung mit solchen.
- 3.6 Teillieferungen auf Wunsch des Käufers werden gesondert berechnet.
- 3.7 Für ausgebrachte Mahnungen werden netto EURO 5,00 Mahnkosten je Mahnung berechnet.
- IV Eigentumsvorbehalt
- 4.1 Die gelieferte Ware bleibt unser Eigentum bis zur Bezahlung sämtlicher, auch künftig entstehender Forderungen aus der Geschäftsverbindung, gleichgültig auf welchem Rechtsgrund sie beruhen mögen. Bei laufender Rechnung gilt der Eigentumsvorbehalt als Sicherung unserer Saldoforderung.
- 4.2 Der Käufer darf die dem Eigentumsvorbehalt unterliegende Ware im ordnungsgemäßen Geschäftsgang weiterveräußern, jedoch nur gegen Barzahlung oder unter Eigentumsvorbehalt und unter der Bedingung, dass seine Forderung aus der Veräußerung auf uns übergeht. Zu anderen Verfügungen, insbesondere zur Verpfändung oder Sicherungsübereignung ist der Käufer nicht berechtigt.
- 4.3 Der Käufer tritt schon hiermit alle Ansprüche gegen Dritte an uns ab, die sich aus Verträgen, Verfügungen oder sonstigen Rechtshandlungen mit Bezug auf die Vorbehaltsware ergeben, einschließlich seiner Handelsspanne. Wird die Handelsware zusammen mit uns nicht gehörenden Gegenständen zu einem Gesamtpreis weiterveräußert oder bezieht sich die Forderung aus der Weiterveräußerung zugleich auf von dem Käufer erbrachte sonstige Leistungen, so wird mit Vorrang vor der übrigen Forderung nur der Teilbetrag an uns abgetreten, der dem Rechnungswert der von uns gelieferten Ware entspricht.
- 4.4 Die Verarbeitung der gelieferten Ware erfolgt für uns, ohne dass uns hieraus Verpflichtungen entstehen. Im Falle der Verarbeitung und Verbindung unserer Ware mit anderer, uns nicht gehörender Ware, durch den Käufer, steht uns das Miteigentum der neuen Sache im Verhältnis des Wertes der Vorbehaltsware zu den übrigen Waren zum Zeitpunkt der Verarbeitung oder Verbindung zu. Für den Fall, dass der Käufer bereits vor der Verarbeitung der Sache eine Anwartschaft begründet hat, vereinbaren Käufer und Verkäufer hiermit, dass an der durch die Verarbeitung neu entstandenen Sache ein gleichwertiges Anwartschaftsrecht entsteht.
- 4.5 Der Käufer bleibt trotz der Abtretung zur Einziehung der Forderungen ermächtigt, die aus den Verträgen, Verfügungen oder sonstigen Rechtshandlungen gemäß Ziffer 4.3 entstehen. Unsere Einziehungsbefugnis bleibt von derjenigen des Käufers unberührt. Wir werden die Forderungen jedoch nicht einziehen, solange seitens des Käufers kein Zahlungsverzug, Zahlungsunfähigkeit, Insolvenz oder eine sonstige Gefährdung des Sicherungsinteresses des Verkäufers vorliegt. Wir können von ihm jederzeit die zur Geltendmachung unserer Ansprüche erforderlichen Auskünfte verlangen.
- 4.6 Der Käufer hat uns von bevorstehenden oder erfolgten Zugriffen Dritter auf die unserem Eigentumsvorbehalt unterliegende Ware oder die uns abgetretenen Ansprüche, sowie von sonstigen Beeinträchtigungen, insbesondere durch Globalabtretungen, unverzüglich zu benachrichtigen. Die Kosten einer Abwehr der Eingriffe Dritter hat der Käufer zu tragen, wenn er den Verkäufer nicht oder nicht rechtzeitig benachrichtigt sowie im Falle einer erfolgreichen Intervention, wenn die Vollstreckung der Kosten bei dem Beklagten als Kostenschuldner vergeblich versucht wurde.
- 4.7 Wir sind berechtigt, die Herausgabe der in unserem Eigentum stehenden Ware zu verlangen, wenn der Käufer sich im Zahlungsverzug befindet, oder er gegen die ihm obliegenden Verpflichtungen verstößt; Ziffer 8 gilt entsprechend. Gegen diesen Herausgabeanspruch kann ein Zurückbehaltungsrecht nicht geltend gemacht werden. Im Falle von Zahlungsverzug, Insolvenz, Zahlungsunfähigkeit oder einer sonstigen Gefährdung des Sicherungsinteresses des Verkäufers können wir die Ermächtigung zur Weiterveräußerung oder zur Einziehung der uns abgetretenen Forderungen widerrufen. Das Geltendmachen des Herausgabeanspruches und die Pfändung einer in unserem Eigentum stehenden Ware durch uns gelten nicht als Rücktritt vom Vertrag.
- 4.8 Auf Anforderung des Käufers werden wir die uns hiernach zustehenden Sicherungen insoweit freigeben, als ihr Wert die sichernde Forderung um 20 % oder mehr übersteigt.
- V Verpackung, Versand und Gefährübergang
- 5.1 Die Ware wird auf Kosten des Käufers verpackt. Einwegverpackungen werden nicht zurückgenommen.
- 5.2 Der Versand erfolgt nach unserer Wahl ab Werk oder Lager für Rechnung und auf Gefahr des Käufers. Die Versandart behalten wir uns vor. Die Gefahr geht, auch bei frachtfreier Lieferung, spätestens mit der Absendung der jeweiligen Lieferung auf den Käufer über.
- 5.3 Zur Anwendung kommen die am Tage des Auftragsbeginns gültigen Listenpreise bei einer Lieferfrist von maximal einem Monat. Pro Lieferung wird innerhalb von Deutschland ein Versandkostenanteil in Höhe von € 6,00 berechnet. Bei Kommissionsbestellungen an Versandadresse (neutrale Anschrift) erheben wir eine Kostenpauschale von Euro 10,00 netto. Bei Sonderanfertigungen berechnen wir einen Bearbeitungsaufschlag. Ein Umtausch ist ausgeschlossen. Jede Erhöhung der Frachtkosten durch nachträgliche Änderung der Verpackungsart, des Beförderungsweges oder ähnlicher auf die Frachtkosten einwirkende Umstände hat der Käufer zu tragen.
- 5.4 Etwaige Verluste und Beschädigungen sind sofort beim Empfang der Ware – möglichst vor dem Abladen – bei der Bahn, dem Lastzugführer oder dem Paketdienstfahrer anzumelden. Dabei hat der Käufer sich die Beanstandungen auf dem Frachtbrief oder der sonst dafür vorgesehenen Verhandlungsniederschrift bescheinigen zu lassen und uns diese binnen 2 Tagen zuzusenden.
- 5.5 Auftragsbestätigungen müssen seitens des Käufers unverzüglich, innerhalb von 2 Arbeitstagen geprüft und Korrekturen, oder Änderungen dem Verkäufer mitgeteilt werden. Bei nachträglichen Korrekturen oder Änderungen können zusätzlichen Kosten auftreten.
- VI Lieferfristen und Lieferhindernisse
- 6.1 Die Lieferfrist beginnt mit der Mitteilung sämtlicher für die Ausführung des Auftrages wesentlicher Umstände durch den Käufer. Sie ist eingehalten, wenn bis zu ihrem Ablauf die Versandbereitschaft mitgeteilt ist oder die Ware das Werk verlassen hat.
- 6.2 Vereinbarte Lieferfristen sind nur annähernd maßgeblich; geringfügige Überschreitungen sind als vertragsgemäß hinzunehmen.
- 6.3 Falls wir oder unser Zulieferer durch unvorhergesehene Ereignisse, die er bzw. wir auch bei Beachtung der zumutbaren Sorgfalt nicht abwenden können, wie z. B. Energie- oder Materialmangel, Betriebsstörung, Streik und Aussperung in unserer Branche oder bei unserem Zulieferer, an der rechtzeitigen Lieferung gehindert sind, sind wir berechtigt, nach unserer Wahl die Lieferfristen um die entsprechende Dauer zu verlängern, oder bei nicht nur kurzfristiger Hinderung ganz oder teilweise vom Vertrag zurückzutreten.
- 6.4 erzugsstrafen und die Haftung für leicht fahrlässig verursachte Verzugschäden an nicht wesentlichen Rechtsgütern, insbesondere Gesundheit, Körper und Leben werden unbeschadet eines gesetzlichen Rücktrittsrechts ausdrücklich abgelehnt.
- 6.5 Setzt uns der Käufer, nachdem wir aus anderen als den in Ziffer 6.3 genannten Gründen bereits in Verzug geraten sind, schriftlich eine angemessene Nachfrist, so ist er nach fruchtlosem Ablauf dieser Frist berechtigt, vom Vertrag zurückzutreten. Schadensersatz statt Leistung steht dem Käufer nur zu, wenn der Verzug auf Vorsatz oder grobe Fahrlässigkeit beruht; sie sind der Höhe nach auf den vorhersehbaren Schaden beschränkt.

- 6.6 Der Haftungsausschluss gemäß 6.4 und die Haftungsbegrenzung gemäß 6.5 gelten nicht, sofern ein kaufmännisches Fixgeschäft schriftlich vereinbart wurde und wir die Lieferverzögerung zu vertreten haben.
- 6.7 Wir sind zu Teilleistungen berechtigt, soweit dies dem Käufer zumutbar ist.
- 6.8 Alle Produkte aus dem Katalog 2017, die nicht im Katalog 2020 vorhanden sind, bleiben verfügbar, solange der Vorrat reicht
- VII Sachmängelhaftung
- 7.1 Wir haften dem Käufer nach Maßgabe der folgenden Bestimmungen für die Schäden, die ihm durch die eigene Verwendung des Liefergegenstandes und dadurch entstanden sind, dass er aus dem Weiterverkauf für Schäden eintreten muss, die dem Fachhandwerker oder dessen Abnehmer durch die Verwendung des Liefergegenstandes entstehen. Voraussetzung ist, dass der Liefergegenstand durch einen zugelassenen Fachhandwerker montiert worden ist. Wir haften nicht, wenn unsere Montage-, Betriebs- und Pflegeanleitung nicht beachtet worden sind und hierdurch der Mangel bedingt ist. Der Käufer ist berechtigt, seinerseits gegenüber dem Fachhandwerker eine Haftung nach Maßgabe der nachfolgenden Bestimmungen zu übernehmen. Ausstellungsware ist von der Gewährleistung nur erfasst, wenn diese Ware in unserem aktuellen Katalog enthalten ist. Ist die Ausstellungsware in dem aktuellen Katalog nicht enthalten, so hat uns der Käufer bei Inanspruchnahme durch Dritte auf erstes Anfordern freizustellen.
- 7.2 Für die von uns gelieferte Ware leisten wir Gewähr für einwandfreies Material, fachgerechte Konstruktion und Herstellung. Die Gewährleistung erstreckt sich auch dar-auf, dass wir die zum Herstellungszeitpunkt gültigen einschlägigen DIN-Normen, Bau- und Prüfgrundsätze, amtliche Prüfzeugnisse und Prüfbescheide eingehalten haben, sofern wir uns in unseren Verkaufsunterlagen darauf bezogen haben. Ferner haften wir für Schäden, die entstehen, falls unsere dem Produkt beige-fügte Montage und Bedienungsanleitung unrichtig sind, sofern uns ein Verschulden nach 7.8 trifft
- 7.3 Die in unseren Katalogen und Prospekten gemachten Angaben und Beschreibungen sind nur maßgeblich, wenn nicht ausdrücklich auf Abweichungen hingewiesen wird. Sollten sich produktionsbedingt oder aus sonstigen Gründen Änderungen von in den Katalogen und Prospekten angegebenen Maßen, Gewichten, Oberflächen-beschaffenheiten und Farbtönen ergeben, so wird der Käufer in einem verbindlichen Angebot auf die relevanten Änderungen hingewiesen. Nimmt der Käufer dieses Angebot durch schriftliche Erklärung an, so sind allein die geänderten Leistungsangaben verbindlich. Als Annahme dieses Angebotes gilt, wenn der Käufer binnen 2 Wochen ab Zugang des geänderten Angebotes keine Ablehnung erklärt. Der Käufer ist verpflichtet, vor Aushändigung von Katalogen und Prospekten bzw. Weitergabe der in Katalogen und Prospekten enthaltenen Angaben sicherzustellen, dass es sich um die aktuellen Kataloge und Prospekte handelt. Kataloge und Prospekte, deren Erscheinungsjahr zumindest zwei Jahre zurückliegt, sind veraltete Kataloge und Prospekte. Jeder neue Katalog und jedes neue Prospekt ersetzt die alten, die ihre Gültigkeit verlieren. Sollten veraltete Kataloge und Prospekte verwendet werden, so sind wir von der Gewährleistung befreit. Die Haftungsfreistellung tritt auch ein, wenn dem Käufer aufgrund der von uns versandten Preislisten und Rundschreiben bekannt ist oder bekannt sein müsste, dass es sich bei der gelieferten Ware um ein Auslaufmodell handelt, und der Käufer diese Ware zu einem Zeitpunkt weiterverkauft, zu dem die Ware von uns nicht mehr produziert wird. Bei eventueller Inanspruchnahme durch Dritte hat der Käufer uns auf erstes Anfordern freizustellen. Vorbehaltlich abweichender Individualvereinbarungen, insbesondere der Garantie bestimmter Eigenschaften, sind kleinere herstellungsbedingte Abweichungen insbesondere in Bezug auf die Oberflächenbeschaffenheit sowie der Farbtöne im Rahmen der handelsüblichen Toleranzen, wenn sie den Gesamteindruck und die Funktionsfähigkeit des Liefergegenstandes nicht unzumutbar beeinträchtigen, als der vereinbarten Beschaffenheit entsprechend anzusehen. Gleiches gilt für kleinere Abweichungen von Abbildung, Maß- und Gewichtsangaben in unseren Katalogen, Prospekten, Angeboten sowie schriftlichen Bestätigungen.
- 7.4 Der Käufer ist verpflichtet, die Ware unverzüglich nach Empfang zu untersuchen. Beanstandungen der Lieferung, insbesondere alle bei sorgfältiger Prüfung äußerlich erkennbaren Mängel, müssen vor Montage und innerhalb von 2 Wochen nach Empfang der Ware schriftlich bei uns eingegangen sein. Andere Mängel und etwa eintretende Folgeschäden müssen uns unverzüglich, spätestens jedoch innerhalb von 2 Wochen nachdem sie entdeckt wurden oder hätten entdeckt werden können, gemeldet werden. Käufer und Fachhandwerker müssen dafür sorgen, dass unverzüglich alle erforderlichen Maßnahmen zur Schadensminderung getroffen werden. Uns ist Gelegenheit zu geben, die mangelhaften Teile und die Schäden an Ort und Stelle in unverändertem Zustand zu besichtigen. Die aufgrund einer verzögerten Mängelanzeige entstehenden Mehr-kosten sind vom Käufer zu tragen. § 377 HGB bleibt daneben unberührt. Nur in dringenden Fällen der Gefährdung der Sicherheit und zur Abwehr unverhältnismäßig großer Schäden oder wenn wir uns mit der Instandsetzung im Verzug befinden oder uns ausdrücklich damit einverstanden erklären, haben Käufer und Fachhandwerker das Recht, den Mangel am Liefergegenstand selbst oder durch Dritte zu beseitigen. Werden diese Verpflichtungen nicht beachtet, entfällt unsere Gewährleistung bzw. Haftung.
- 7.5 Die Gewährleistungsfrist beträgt 2 Jahre ab Einbau, mindestens jedoch die gesetzliche Gewährleistungsfrist. Der Anspruch wegen Schlechtleistung bei der Nacherfüllung verjährt in 2 Jahren ab Lieferung.
- 7.6 Soweit wir nach den vorangehenden Bestimmungen Gewähr leisten, können wir die mangelhaften Teile unentgeltlich nach unserer Wahl entweder neu liefern oder selbst oder durch Dritte in Stand setzen. Soweit der Käufer und der Fachhandwerker gemäß 7.4 berechtigt sind, den Mangel selbst oder durch Dritte zu beseitigen, ersetzen wir auch die erforderlichen Aus- und Einbaukosten.
- 7.7 Sind wir zur Nacherfüllung nicht bereit oder nicht in der Lage, insbesondere verzögert sich diese über eine angemessene Frist hinaus oder schlägt sie in sonstiger Weise fehl, so ist der Käufer nach seiner Wahl berechtigt zu verlangen, dass der Vertrag rückgängig gemacht, der Kaufpreis entsprechend herabgesetzt wird oder nach den nach-folgenden Bestimmungen Schadensersatz geleistet wird.
- 7.8 Unsere Haftung für eigene Pflichtverletzung sowie für solche unserer Vorrichtungen- oder Erfüllungsgehilfen ist im Falle von Vorsatz und grober Fahrlässigkeit auf vorhersehbare Schäden beschränkt. Von dieser Beschränkung ausgeschlossen ist die Haftung wegen der Verletzung von Leben, Körper und Gesundheit.
- 7.9 Wir haften für eigene Pflichtverletzung sowie für solche unserer Vorrichtungen- oder Erfüllungsgehilfen im Falle leichter Fahrlässigkeit nur bei Verletzung unserer Pflichten aus 7.2, begrenzt auf Schäden bis zu einer Höchstsumme von € 150.000 pro Schadensfall. Eine darüber hinaus gehende Haftung ist ausgeschlossen. Von dieser Beschränkung ausgeschlossen ist die Haftung wegen der Verletzung von Leben Körper und Gesundheit.
- VIII Rücknahme von Material
- 8.1 Von uns gelieferte mangelfreie Ware wird grundsätzlich nicht zurückgenommen. Erklären wir uns im Einzelfall nach vorheriger schriftlicher Vereinbarung ausnahmsweise hierzu bereit, so schreiben wir dem Käufer den Rechnungsbetrag abzüglich 30 % für Prüfungs- und Handierungskosten und für entgangene Gewinne gut. Notwendige Aufarbeitungskosten werden zusätzlich berechnet. Die Transportgefahr und die Transportkosten trägt der Käufer.
- 8.2 Ist eine Rücknahme bewilligt, so kann diese nur mittels einem von der JATEC GmbH oder von deren Bevollmächtigten ausgestellten Retourenschein versehen mit einer Bearbeitungsnummer erfolgen.
- IX Schutzrechte
- 9.1 Modelle und Zeichnungen bleiben, vorbehaltlich anderweitiger Individualabrede, unser Eigentum, auch wenn der Käufer die Kosten dafür ganz oder anteilig trägt. Bei Anfertigung nach Angaben des Käufers oder nach Mustern ist dieser voll dafür verantwortlich, dass dadurch nicht Schutzrechte oder andere Rechte Dritter verletzt wer-den. Er hat uns von Ansprüchen Dritter freizustellen. Wird uns die Lieferung oder Herstellung von einem Dritten unter Berufung auf ein ihm gehörendes Schutzrecht untersagt, so sind wir – ohne Überprüfung der Rechtslage, jedoch nach Benachrichtigung des Käufers – berechtigt, die Arbeiten einzustellen und Ersatz der aufgewen-deten Kosten zu verlangen, es sei denn, der Käufer weist gerichtlich nach, dass die Geltendmachung unberechtigt ist.
- 9.2 Bei Anfertigung nach Angaben des Käufers oder nach Muster gilt eine Mehr- oder Minderlieferung bis zu 10 % als geringfügig und damit als vertragsgemäß.
- X Erfüllungsort, Gerichtsstand, Rechtswahl
- 10.1 Erfüllungsort für Lieferung ist der jeweilige Versandort, für Zahlungen unser Sitz.
- 10.2 Ausschließlicher Gerichtsstand, auch für Scheck- sowie Wechselklagen, ist in Offenbach.
- 10.3 Es gilt ausschließlich deutsches Recht. Das UN-Übereinkommen über Verträge über den internationalen Warenverkauf vom 11. 04. 1980 (CISG) gilt nicht.

Stand August 2020

CODE	PAG
1A000CD13J2B05XJA	148
1A000CD13J2B8BXJA	148
1A000CD13J2B46XJA	148
1A000CD13J2M05XJA	148
1A000CD13J2M8BXJA	148
1A000CD13J2M46XJA	148
1A000CD13J2Y05XJA	148
1A000CD13J2Y8BXJA	148
1A000CD13J2Y46XJA	148
1A000CD17D2B1MXZA	415
1A000CD17D2B02XZA	415
1A000CD17D2B05XZA	415
1A000CD17D2B8FXZA	415
1A000CD17D2B18XZA	415
1A000CD17D2B31XZA	415
1A000CD17D2B43XZA	415
1A000CD17D2B46XZA	415
1A000CD17D2B47XZA	415
1A000CD17D2BBQXZA	415
1A000CD17D2C1MXZA	416
1A000CD17D2C02XZA	416
1A000CD17D2C05XZA	416
1A000CD17D2C8FXZA	416
1A000CD17D2C18XZA	416
1A000CD17D2C31XZA	416
1A000CD17D2C43XZA	416
1A000CD17D2C46XZA	416
1A000CD17D2C47XZA	416
1A000CD17D2CBQXZA	416
1A000CD17D2M1MXZA	415
1A000CD17D2M02XZA	415
1A000CD17D2M05XZA	415
1A000CD17D2M8FXZA	415
1A000CD17D2M18XZA	415
1A000CD17D2M31XZA	415
1A000CD17D2M43XZA	415
1A000CD17D2M46XZA	415
1A000CD17D2M47XZA	415
1A000CD17D2MBQXZA	415
1A000CD17D2Y1MXZA	416
1A000CD17D2Y02XZA	416
1A000CD17D2Y05XZA	416
1A000CD17D2Y8FXZA	416
1A000CD17D2Y18XZA	416
1A000CD17D2Y31XZA	416
1A000CD17D2Y43XZA	416
1A000CD17D2Y46XZA	416
1A000CD17D2Y47XZA	416
1A000CD17D2YBQXZA	416
1A000CDJ032B50XJA	144
1A000CDJ032B5SXJA	144
1A000CDJ032B05XJA	144
1A000CDJ032B8BXJA	144
1A000CDJ032B46XJA	144
1A000CDJ032B98XJA	144
1A000CDJ032C05AJA	144
1A000CDJ032C50AJA	144
1A000CDJ032C5SAJA	144
1A000CDJ032C8BAJA	144
1A000CDJ032C46AJA	144
1A000CDJ032C98AJA	144
1A000CDJ032M50XJA	144
1A000CDJ032M5SXJA	144
1A000CDJ032M05XJA	144
1A000CDJ032M8BXJA	144
1A000CDJ032M46XJA	144
1A000CDJ032M98XJA	144

CODE	PAG
1A000CDJ032Y50XJA	144
1A000CDJ032Y5SXJA	144
1A000CDJ032Y05XJA	144
1A000CDJ032Y8BXJA	144
1A000CDJ032Y46AJA	144
1A000CDJ032Y98XJA	144
1A000CDJ042B05XJA	146
1A000CDJ042B46XJA	146
1A000CDJ042B98XJA	146
1A000CDJ042BK1XJA	146
1A000CDJ042C05XJA	146
1A000CDJ042C46XJA	146
1A000CDJ042C98XJA	146
1A000CDJ042CK1XJA	146
1A000CDJ042M05XJA	146
1A000CDJ042M46XJA	146
1A000CDJ042M98XJA	146
1A000CDJ042MK1XJA	146
1A000CDJ042Y05XJA	146
1A000CDJ042Y46XJA	146
1A000CDJ042Y98XJA	146
1A000CDJ042YK1XJA	146
1A000CDJ102B5SXJA	142
1A000CDJ102B05XJA	142
1A000CDJ102B18XJA	142
1A000CDJ102B46XJA	142
1A000CDJ102B98XJA	142
1A000CDJ102BK1XJA	142
1A000CDJ102C5SXJA	142
1A000CDJ102C05XJA	142
1A000CDJ102C18XJA	142
1A000CDJ102C46XJA	142
1A000CDJ102C98XJA	142
1A000CDJ102CK1XJA	142
1A000CDJ102M5SXJA	142
1A000CDJ102M05XJA	142
1A000CDJ102M18XJA	142
1A000CDJ102M46XJA	142
1A000CDJ102M98XJA	142
1A000CDJ102MK1XJA	142
1A000CDJ102Y5SXJA	142
1A000CDJ102Y05XJA	142
1A000CDJ102Y18XJA	142
1A000CDJ102Y46XJA	142
1A000CDJ102Y98XJA	142
1A000CDJ102YK1XJA	142
1A000CDJ182B05XJA	149
1A000CDJ182B18XJA	149
1A000CDJ182B46XJA	149
1A000CDJ182BK1XJA	149
1A000CDJ182C05XJA	149
1A000CDJ182C18XJA	149
1A000CDJ182C46XJA	149
1A000CDJ182CK1XJA	149
1A000CDJ182M05XJA	149
1A000CDJ182M18XJA	149
1A000CDJ182M46XJA	149
1A000CDJ182MK1XJA	149
1A000CDJ182Y05XJA	149
1A000CDJ182Y18XJA	149
1A000CDJ182Y46XJA	149
1A000CDJ182YK1XJA	149
1A000CDJ302B5SXJA	151
1A000CDJ302B05XJA	151
1A000CDJ302B18XJA	151
1A000CDJ302B46XJA	151
1A000CDJ302BK1XJA	151

CODE	PAG
1A000CDJ302C5SXJA	151
1A000CDJ302C05XJA	151
1A000CDJ302C18XJA	151
1A000CDJ302C46XJA	151
1A000CDJ302CK1XJA	151
1A000CDJ302M5SXJA	151
1A000CDJ302M05XJA	151
1A000CDJ302M18XJA	151
1A000CDJ302M46XJA	151
1A000CDJ302MK1XJA	151
1A000CDJ302Y5SXJA	151
1A000CDJ302Y05XJA	151
1A000CDJ302Y18XJA	151
1A000CDJ302Y46XJA	151
1A000CDJ302YK1XJA	151
1A000CDJ362B1MXJA	153
1A000CDJ362B05XJA	153
1A000CDJ362B8BXJA	153
1A000CDJ362B46XJA	153
1A000CDJ362B98XJA	153
1A000CDJ362C1MXJA	153
1A000CDJ362C05XJA	153
1A000CDJ362C8BXJA	153
1A000CDJ362C46XJA	153
1A000CDJ362C98XJA	153
1A000CDJ362M1MXJA	153
1A000CDJ362M05XJA	153
1A000CDJ362M8BXJA	153
1A000CDJ362M46XJA	153
1A000CDJ362M98XJA	153
1A000CDJ362Y1MXJA	153
1A000CDJ362Y05XJA	153
1A000CDJ362Y8BXJA	153
1A000CDJ362Y46XJA	153
1A000CDJ362Y98XJA	153
1A000CDJ372B5SXJA	155
1A000CDJ372B05XJA	155
1A000CDJ372B18XJA	155
1A000CDJ372C5SXJA	155
1A000CDJ372C05XJA	155
1A000CDJ372C18XJA	155
1A000CDJ372M5SXJA	155
1A000CDJ372M05XJA	155
1A000CDJ372M18XJA	155
1A000CDJ372Y5SXJA	155
1A000CDJ372Y05XJA	155
1A000CDJ372Y18XJA	155
1A000CDJ502Y5SXJA	234
1A000CDJ502Y18XJA	234
1A000CDJ502Y46XJA	234
1A000CDJ502Y5SXJA	234
1A000CDJ502Y18XJA	234
1A000CDQD72B18XZA	416
1A000CDQD72B31XZA	416
1A000CDQD72C18XZA	417
1A000CDQD72C31XZA	417
1A000CDQD72M18XZA	416
1A000CDQD72M31XZA	416
1A000CDQD72Y18XZA	416
1A000CDQD72Y31XZA	416
1A001CMXX5205CZA	410
1A001CMXX5231CZA	410
1A001DK0150005XZA	349
1A001DK0150031XZA	349
1A001DK0153005XZA	349
1A001DK0153031XZA	349
1A001DK0153505XZA	349

CODE	PAG
1A001DK0153531XZA	349
1A001DK0753005XZA	350
1A001DK0753031XZA	350
1A001DK0753505XZA	350
1A001DK0753531XZA	350
1A001DK0755005XZA	350
1A001DK0755031XZA	350
1A001DKC800005XZA	350
1A001DKC800031XZA	350
1A001DKC803005XZA	350
1A001DKC803031XZA	350
1A001DKC803505XZA	350
1A001DKC803531XZA	350
1A001DKT800005XZA	351
1A001DKT800031XZA	351
1A001DKT803005XZA	351
1A001DKT803031XZA	351
1A001DKT803505XZA	351
1A001DKT803531XZA	351
1A001ID0066305CZA	410
1A001ID0066331CZA	410
1A001IPI066305CZA	410
1A001IPI066331CZA	410
1A001IS0066305CZA	410
1A001IS0066331CZA	410
1A001MP001B631XZA	349
1A001MP0011331XZA	349
1A001MR0093105DZA	348
1A001MR0093131DZA	348
1A001MR0093205DZA	348
1A001MR0093231DZA	348
1A001MRD173105ZZA	348
1A001MRD173131ZZA	348
1A001MRD173205ZZA	348
1A001MRD173231ZZA	348
1A001PG0012431VZA	349
1A001PM0061331JZA	349
1A001PM0061331LZA	349
1A001PM00613205YZA	348
1A001PMD013231YZA	348
1A001RG0094205DZA	348
1A001RG0094231DZA	348
1A001RGD174205ZZA	348
1A001RGD174231ZZA	348
1A002CMXX5218CZA	409
1A002DK0150018XZA	344
1A002DK0153018XZA	344
1A002DK0153518XZA	344
1A002DK0753518XZA	345
1A002DK0755018XZA	345
1A002DKC800018XZA	345
1A002DKC803018XZA	345
1A002DKC803518XZA	345
1A002DKT800018XZA	345
1A002DKT803018XZA	345
1A002DKT803518XZA	345
1A002ID0066318CZA	409
1A002IPI066318CZA	409
1A002IS0066318CZA	409
1A002MRD173118ZZA	344
1A002MRD173218ZZA	344
1A002PMD013218YZA	344
1A002RGD174218ZZA	344
1A004CMXX5205CZA	408
1A004CMXX5218CZA	408
1A004DK0150005XZA	321

CODE	PAG	CODE	PAG	CODE	PAG	CODE	PAG
1A004DK0150018XZA	321	1A004MRQ093205DZA	315	1A10NRWD1N85NWDZA	366	1A040MR00932BQDZA	308
1A004DK0153005XZA	321	1A004MRQ093218DZA	315	1A016GR195644BXXH	417	1A040MR009311MDZA	308
1A004DK0153018XZA	321	1A004MRQD73105ZZA	314	1A018GR195644BXXX	171	1A040MR009321MDZA	308
1A004DK0153505XZA	321	1A004MRQD73118ZZA	314	1A022BNXXXXX05XZA	415	1A040MR0093147DZA	308
1A004DK0153518XZA	321	1A004MRQD73205ZZA	314	1A022BNXXXXX18XZA	415	1A040MR0093247DZA	308
1A004DK0753005XZA	322	1A004MRQD73218ZZA	314	1A022BYXXXXX05XZA	415	1A040MRD1731BQZZA	308
1A004DK0753018XZA	322	1A004MRT013105ZZA	320	1A022BYXXXXX18XZA	415	1A040MRD1732BQZZA	308
1A004DK0753505XZA	322	1A004MRT013118ZZA	320	1A022ROXXXXX05XZA	415	1A040MRD17311MZZA	308
1A004DK0753518XZA	322	1A004MRT013205ZZA	320	1A022ROXXXXX18XZA	415	1A040MRD17321MZZA	308
1A004DK0755005XZA	322	1A004MRT013218ZZA	320	1A032CDJ00XX3DXXX	177	1A040MRD173147ZZA	308
1A004DK0755018XZA	322	1A004PMD013205YZA	320	1A033CDJ00XX3DXXX	177	1A040MRD173247ZZA	308
1A004DKC800005XZA	322	1A004PMD013218YZA	320	1A035CDJ00XX3AXXX	177	1A040PD04013BQDZA	407
1A004DKC800018XZA	322	1A004PMD033205YZA	314	1A040CMXX52BQCZA	407	1A040PD040131MDZA	407
1A004DKC803005XZA	322	1A004PMD033218YZA	314	1A040CMXX521MCZA	407	1A040PD0401347DZA	407
1A004DKC803018XZA	322	1A004RQ0094205DZA	321	1A040CMXX5247CZA	407	1A040PG04024BQVZA	309
1A004DKC803505XZA	322	1A004RQ0094218DZA	321	1A040DK01500BQXZA	309	1A040PG040241MVZA	309
1A004DKC803518XZA	322	1A004RQD174205ZZA	320	1A040DK01530BQXZA	309	1A040PG0402447VZA	309
1A004DKC810005XZA	316	1A004RQD174218ZZA	320	1A040DK01535BQXZA	309	1A040PM01113BQJZA	309
1A004DKC810018XZA	316	1A004RQ0014205ZZA	314	1A040DK07530BQXZA	310	1A040PM01113BQLZA	309
1A004DKC813005XZA	316	1A004RQ0014218ZZA	314	1A040DK07535BQXZA	310	1A040PM011131MJZA	309
1A004DKC813018XZA	316	1A004RQ0094205DZA	315	1A040DK07550BQXZA	310	1A040PM011131MLZA	309
1A004DKC813505XZA	316	1A004RQ0094218DZA	315	1A040DK015001MXZA	309	1A040PM0111347JZA	309
1A004DKC813518XZA	316	1A004RQ0074205ZZA	314	1A040DK015301MXZA	309	1A040PM0111347LZA	309
1A004DKQ150005XZA	315	1A004RQ0074218ZZA	314	1A040DK015351MXZA	309	1A040PMD0532BQYZA	308
1A004DKQ150018XZA	315	1A004RQT014205ZZA	320	1A040DK075301MXZA	310	1A040PMD05321MYZA	308
1A004DKQ153005XZA	315	1A004RQT014218ZZA	320	1A040DK075351MXZA	310	1A040PMD053247YZA	308
1A004DKQ153018XZA	315	1A004TKQ150005XZA	317	1A040DK075501MXZA	310	1A040PS04013BQDZA	407
1A004DKQ153505XZA	315	1A004TKQ150018XZA	317	1A040DK0150047XZA	309	1A040PS0401347DZA	407
1A004DKQ153518XZA	315	1A004TKQ153005XZA	317	1A040DK0153047XZA	309	1A040RG00942BQDZA	308
1A004DKQ753005XZA	316	1A004TKQ153018XZA	317	1A040DK0153547XZA	309	1A040RG009421MDZA	308
1A004DKQ753018XZA	316	1A004TKQ153505XZA	317	1A040DK0753047XZA	310	1A040RG0094247DZA	308
1A004DKQ753505XZA	316	1A004TKQ153518XZA	317	1A040DK0753547XZA	310	1A040RGD1742BQZZA	308
1A004DKQ753518XZA	316	1A10NDKC8100NRXZA	367	1A040DK0755047XZA	310	1A040RGD17421MZZA	308
1A004DKQ755005XZA	316	1A10NDKC8100NWXZA	367	1A040DKC8000BQXZA	310	1A040RGD174247ZZA	308
1A004DKQ755018XZA	316	1A10NDKC8130NRXZA	367	1A040DKC8030BQXZA	310	1A040TK01500BQXZA	311
1A004DKT800005XZA	323	1A10NDKC8130NWXZA	367	1A040DKC8035BQXZA	310	1A040TK01530BQXZA	311
1A004DKT800018XZA	323	1A10NDKC8135NRXZA	367	1A040DKC80001MXZA	310	1A040TK01535BQXZA	311
1A004DKT803005XZA	323	1A10NDKC8135NWXZA	367	1A040DKC80301MXZA	310	1A040TK015001MXZA	311
1A004DKT803018XZA	323	1A10NDKQ1500NOXZA	366	1A040DKC80351MXZA	310	1A040TK015301MXZA	311
1A004DKT803505XZA	323	1A10NDKQ1500NRXZA	366	1A040DKC800047XZA	310	1A040TK015351MXZA	311
1A004DKT803518XZA	323	1A10NDKQ1500NWXZA	366	1A040DKC803047XZA	310	1A040TK0150047XZA	311
1A004DKT810005XZA	317	1A10NDKQ1530NOXZA	366	1A040DKC803547XZA	310	1A040TK0153047XZA	311
1A004DKT810018XZA	317	1A10NDKQ1530NRXZA	366	1A040DKT8000BQXZA	310	1A040TK0153547XZA	311
1A004DKT813005XZA	317	1A10NDKQ1530NWXZA	366	1A040DKT8030BQXZA	310	1A069CMXXX528ECZA	404
1A004DKT813018XZA	317	1A10NDKQ1535NOXZA	366	1A040DKT8035BQXZA	310	1A069CMXXX528NCZA	404
1A004DKT813505XZA	317	1A10NDKQ1535NRXZA	366	1A040DKT80001MXZA	310	1A069CMXXX5254CZA	404
1A004DKT813518XZA	317	1A10NDKQ1535NWXZA	366	1A040DKT80301MXZA	310	1A069CMXXX5259CZA	404
1A004ID0066305CZA	408	1A10NDKT8100NRXZA	367	1A040DKT80351MXZA	310	1A069CMXXX5265CZA	404
1A004ID0066318CZA	408	1A10NDKT8100NWXZA	367	1A040DKT800047XZA	310	1A069CMXXX5285CZA	404
1A004IPI066305CZA	408	1A10NDKT8130NRXZA	367	1A040DKT803047XZA	310	1A069DK015008EXZA	276
1A004IPI066318CZA	408	1A10NDKT8130NWXZA	367	1A040DKT803547XZA	310	1A069DK015008NXZA	276
1A004IS0066305CZA	408	1A10NDKT8135NRXZA	367	1A040ID00663BQCZA	407	1A069DK015308EXZA	276
1A004IS0066318CZA	408	1A10NDKT8135NWXZA	367	1A040ID0066347CZA	407	1A069DK015358EXZA	276
1A004MR0093105DZA	321	1A10NMDXXXC0NOXZA	422	1A040IPI0663BQCZA	407	1A069DK015358NXZA	276
1A004MR0093118DZA	321	1A10NMDXXXC0NRXZA	422	1A040IPI06631MCZA	407	1A069DK075308EXZA	277
1A004MR0093205DZA	321	1A10NMDXXXC0NWXZA	422	1A040IPI066347CZA	407	1A069DK075308NXZA	277
1A004MR0093218DZA	321	1A10NMDXXXF0NOXZA	423	1A040IPI066347CZA	407	1A069DK075308NXZA	277
1A004MRD173105ZZA	320	1A10NMDXXXF0NRXZA	423	1A040IS00663BQCZA	407	1A069DK075358EXZA	277
1A004MRD173118ZZA	320	1A10NMDXXXF0NWXZA	423	1A040IS006631MCZA	407	1A069DK075358NXZA	277
1A004MRD173205ZZA	320	1A10NMRD1N71NODZA	366	1A040IS0066347CZA	407	1A069DK075508EXZA	277
1A004MRD173218ZZA	320	1A10NMRD1N71NRDZA	366	1A040MP04006BQDZA	309	1A069DK075508NXZA	277
1A004MRQ013105ZZA	314	1A10NMRD1N71NWDZA	366	1A040MP04013BQDZA	309	1A069DK0150054XZA	276
1A004MRQ013118ZZA	314	1A10NMRD1N72NODZA	366	1A040MP040061MDZA	309	1A069DK0150059XZA	276
1A004MRQ013205ZZA	314	1A10NMRD1N72NRDZA	366	1A040MP040131MDZA	309	1A069DK0150065XZA	276
1A004MRQ013218ZZA	314	1A10NMRD1N72NWDZA	366	1A040MP0400647DZA	309	1A069DK0150085XZA	276
1A004MRQ093105DZA	315	1A10NRWD1N85NODZA	366	1A040MP0401347DZA	309	1A069DK0153054XZA	276
1A004MRQ093118DZA	315	1A10NRWD1N85NRDZA	366	1A040MR00931BQDZA	308	1A069DK0153059XZA	276

CODE	PAG	CODE	PAG	CODE	PAG	CODE	PAG
1A069DK0153065XZA	276	1A069IS006638NCZA	404	1A101ID0066305CZA	405	1A124HSQ136931XZA	429
1A069DK0153085XZA	276	1A069IS0066354CZA	404	1A101ID0066346CZA	405	1A124ID0066305CZA	412
1A069DK0153554XZA	276	1A069IS0066359CZA	404	1A101IDI066305CZA	405	1A124ID0066318CZA	412
1A069DK0153559XZA	276	1A069IS0066365CZA	404	1A101IDI066346CZA	405	1A124ID0066331CZA	412
1A069DK0153565XZA	276	1A069IS0066385CZA	404	1A101IS0066305CZA	405	1A124IPI066305CZA	412
1A069DK0153585XZA	276	1A069MRD17318EZZA	276	1A101IS0066346CZA	405	1A124IPI066318CZA	412
1A069DK0753054XZA	277	1A069MRD17318NZZA	276	1A101ISI066305CZA	405	1A124IPI066331CZA	412
1A069DK0753059XZA	277	1A069MRD17328EZZA	276	1A101ISI066346CZA	405	1A124IS0066305CZA	412
1A069DK0753065XZA	277	1A069MRD17328NZZA	276	1A101MRD173105ZZA	280	1A124IS0066318CZA	412
1A069DK0753085XZA	277	1A069MRD173154ZZA	276	1A101MRD173146ZZA	280	1A124IS0066331CZA	412
1A069DK0753554XZA	277	1A069MRD173159ZZA	276	1A101MRD173205ZZA	280	1A124MRQD73105ZZA	376
1A069DK0753559XZA	277	1A069MRD173165ZZA	276	1A101MRD173246ZZA	280	1A124MRQD73118ZZA	376
1A069DK0753565XZA	277	1A069MRD173185ZZA	276	1A101PMD053205JZA	280	1A124MRQD73131ZZA	376
1A069DK0753585XZA	277	1A069MRD173254ZZA	276	1A101PMD053205LZA	280	1A124MRQD73205ZZA	376
1A069DK0755054XZA	277	1A069MRD173259ZZA	276	1A101PMD053246JZA	280	1A124MRQD73218ZZA	376
1A069DK0755059XZA	277	1A069MRD173265ZZA	276	1A101PMD053246LZA	280	1A124MRQD73231ZZA	376
1A069DK0755065XZA	277	1A069MRD173285ZZA	276	1A101RGD174205ZZA	280	1A124NOQD75218XZA	417
1A069DK0755085XZA	277	1A069PMD05328EYZA	276	1A101RGD174246ZZA	280	1A124NOQD75231XZA	417
1A069DKC80008EXZA	277	1A069PMD05328NYZA	276	1A122PN025XX02XZL	446	1A124PMD033205YZA	376
1A069DKC80008NXZA	277	1A069PMD053254YZA	276	1A122PN025XX05XZL	446	1A124PMD033218YZA	376
1A069DKC80308EXZA	277	1A069PMD053259YZA	276	1A124CMXX5205CZA	412	1A124PMD033231YZA	376
1A069DKC80308NXZA	277	1A069PMD053265YZA	276	1A124CMXX5218CZA	412	1A124RQD74218ZZA	376
1A069DKC80358EXZA	277	1A069PMD053285YZA	276	1A124CMXX5231CZA	412	1A124RQD74231ZZA	376
1A069DKC80358NXZA	277	1A069RGD17428EZZA	276	1A124DKC810005XZA	377	1A130MAJQ65105XJA	75
1A069DKC800054XZA	277	1A069RGD17428NZZA	276	1A124DKC810018XZA	377	1A130MAJQ65118XJA	75
1A069DKC800059XZA	277	1A069RGD174254ZZA	276	1A124DKC810031XZA	377	1A130TKE820005XJA	75
1A069DKC800065XZA	277	1A069RGD174259ZZA	276	1A124DKC813005XZA	377	1A130TKE820018XJA	75
1A069DKC800085XZA	277	1A069RGD174265ZZA	276	1A124DKC813018XZA	377	1A130TKE823005XJA	75
1A069DKC803054XZA	277	1A069RGD174285ZZA	276	1A124DKC813031XZA	377	1A130TKE823018XJA	75
1A069DKC803059XZA	277	1A101CMXX5205CZA	405	1A124DKC813505XZA	377	1A130TKE823505XJA	75
1A069DKC803065XZA	277	1A101CMXX5246CZA	405	1A124DKC813518XZA	377	1A130TKE823518XJA	75
1A069DKC803085XZA	277	1A101DK0150005DZA	281	1A124DKC813531XZA	377	1A141CMXX5218CZA	414
1A069DKC803554XZA	277	1A101DK0150005SZA	281	1A124DKQ150005XZA	376	1A141DK0150018XZA	396
1A069DKC803559XZA	277	1A101DK0150046DZA	281	1A124DKQ150018XZA	376	1A141DK0153018XZA	396
1A069DKC803565XZA	277	1A101DK0150046SZA	281	1A124DKQ150031XZA	376	1A141DK0153518XZA	396
1A069DKC803585XZA	277	1A101DK0153005DZA	281	1A124DKQ153005XZA	376	1A141DK0753018XZA	397
1A069DKT80008EXZA	277	1A101DK0153005SZA	281	1A124DKQ153018XZA	376	1A141DK0753518XZA	397
1A069DKT80008NXZA	277	1A101DK0153046DZA	281	1A124DKQ153031XZA	376	1A141DK0755018XZA	397
1A069DKT80308EXZA	277	1A101DK0153046SZA	281	1A124DKQ153505XZA	376	1A141DKC800018XZA	397
1A069DKT80308NXZA	277	1A101DK0153505DZA	281	1A124DKQ153518XZA	376	1A141DKC803018XZA	397
1A069DKT80358EXZA	277	1A101DK0153505SZA	281	1A124DKQ153531XZA	376	1A141DKC803518XZA	397
1A069DKT80358NXZA	277	1A101DK0153546DZA	281	1A124DKQ1535005XZA	377	1A141DKC810018XZA	393
1A069DKT800054XZA	277	1A101DK0153546SZA	281	1A124DKQ753018XZA	377	1A141DKC813018XZA	393
1A069DKT800059XZA	277	1A101DKC800005DZA	282	1A124DKQ753031XZA	377	1A141DKC813518XZA	393
1A069DKT800065XZA	277	1A101DKC800005SZA	282	1A124DKQ753505XZA	377	1A141DKQ150018XZA	392
1A069DKT800085XZA	277	1A101DKC800046DZA	282	1A124DKQ753518XZA	377	1A141DKQ153018XZA	392
1A069DKT803054XZA	277	1A101DKC800046SZA	282	1A124DKQ753531XZA	377	1A141DKQ153518XZA	392
1A069DKT803059XZA	277	1A101DKC803005DZA	282	1A124DKQ755005XZA	377	1A141DKQ153518XZA	393
1A069DKT803065XZA	277	1A101DKC803005SZA	282	1A124DKQ755018XZA	377	1A141DKQ753518XZA	393
1A069DKT803085XZA	277	1A101DKC803046DZA	282	1A124DKQ755031XZA	377	1A141DKQ755018XZA	393
1A069DKT803554XZA	277	1A101DKC803046SZA	282	1A124DKT810005XZA	377	1A141DKT800018XZA	397
1A069DKT803559XZA	277	1A101DKC803505DZA	282	1A124DKT810018XZA	377	1A141DKT803018XZA	397
1A069DKT803565XZA	277	1A101DKC803505SZA	282	1A124DKT810031XZA	377	1A141DKT803518XZA	397
1A069DKT803585XZA	277	1A101DKC803546DZA	282	1A124DKT813005XZA	377	1A141DKT810018XZA	393
1A069ID006638ECZA	404	1A101DKC803546SZA	282	1A124DKT813018XZA	377	1A141DKT813018XZA	393
1A069ID006638NCZA	404	1A101DKT800005DZA	283	1A124DKT813031XZA	377	1A141DKT813518XZA	393
1A069ID0066354CZA	404	1A101DKT800005SZA	283	1A124DKT813505XZA	377	1A141HD3136918XZA	433
1A069ID0066359CZA	404	1A101DKT800046DZA	283	1A124DKT813518XZA	377	1A141HDQ136918XZA	431
1A069ID0066365CZA	404	1A101DKT800046SZA	283	1A124DKT813531XZA	377	1A141HS3130018XZA	433
1A069ID0066385CZA	404	1A101DKT803005DZA	283	1A124HDQ136905XZA	429	1A141HS3136918XZA	433
1A069IPI06638ECZA	404	1A101DKT803005SZA	283	1A124HDQ136918XZA	429	1A141HSQ130018XZA	431
1A069IPI06638NCZA	404	1A101DKT803046DZA	283	1A124HDQ136931XZA	429	1A141HSQ136918XZA	431
1A069IPI066354CZA	404	1A101DKT803046SZA	283	1A124HSQ130005XZA	429	1A141ID0066318CZA	414
1A069IPI066359CZA	404	1A101DKT803505DZA	283	1A124HSQ130018XZA	429	1A141IPI066318CZA	414
1A069IPI066365CZA	404	1A101DKT803505SZA	283	1A124HSQ130031XZA	429	1A141IS0066318CZA	414
1A069IPI066385CZA	404	1A101DKT803546DZA	283	1A124HSQ136905XZA	429	1A141MR0223118CZA	400
1A069IPI06638ECZA	404	1A101DKT803546SZA	283	1A124HSQ136918XZA	429	1A141MR0223218CZA	400

CODE	PAG	CODE	PAG	CODE	PAG	CODE	PAG
1A141MRD173118ZZA	396	1A168IPI0663P7CZA	413	1A180DKT80301MXZA	341	1A260DKC810031XZA	295
1A141MRD173218ZZA	396	1A168IPI066361CZA	413	1A180DKT80351MXZA	341	1A260DKC813018XZA	295
1A141MRQD73118ZZA	392	1A168IS00663P4CZA	413	1A180DKT800005XZA	341	1A260DKC813031XZA	295
1A141MRQD73218ZZA	392	1A168IS00663P6CZA	413	1A180DKT800018XZA	341	1A260DKC813518XZA	295
1A141PMD013218YZA	396	1A168IS00663P7CZA	413	1A180DKT803005XZA	341	1A260DKC813531XZA	295
1A141PMD033218YZA	392	1A168IS0066361CZA	413	1A180DKT803018XZA	341	1A260DKQ150018XZA	294
1A141RGD174218ZZA	396	1A168MP03906P7DZA	381	1A180DKT803505XZA	341	1A260DKQ150031XZA	294
1A141RGQD74218ZZA	392	1A168MP03913P7DZA	381	1A180DKT803518XZA	341	1A260DKQ153018XZA	294
1A141RW0224218BZA	400	1A168MP0390661DZA	381	1A180ID006631MCZA	409	1A260DKQ153031XZA	294
1A168CMXX52P4CZA	413	1A168MP0391361DZA	381	1A180ID0066305CZA	409	1A260DKQ153518XZA	294
1A168CMXX52P6CZA	413	1A168MRD1731P4ZZA	380	1A180ID0066318CZA	409	1A260DKQ153531XZA	294
1A168CMXX52P7CZA	413	1A168MRD1731P6ZZA	380	1A180IPI06631MCZA	409	1A260DKQ753018XZA	294
1A168CMXX5261CZA	413	1A168MRD1731P7ZZA	380	1A180IPI066305CZA	409	1A260DKQ753031XZA	294
1A168DK01500P4XZA	382	1A168MRD1732P4ZZA	380	1A180IPI066318CZA	409	1A260DKQ753518XZA	294
1A168DK01500P6XZA	382	1A168MRD1732P6ZZA	380	1A180IS006631MCZA	409	1A260DKQ753531XZA	294
1A168DK01500P7XZA	382	1A168MRD1732P7ZZA	380	1A180IS0066305CZA	409	1A260DKQ755018XZA	294
1A168DK01530P4XZA	382	1A168MRD173161ZZA	380	1A180IS0066318CZA	409	1A260DKQ755031XZA	294
1A168DK01530P6XZA	382	1A168MRD173261ZZA	380	1A180MP040061MXZA	339	1A260DKT800018XZA	301
1A168DK01530P7XZA	382	1A168PD03913P7DZA	413	1A180MP040131MXZA	339	1A260DKT800031XZA	301
1A168DK01535P4XZA	382	1A168PD0391361DZA	413	1A180MP0400605XZA	339	1A260DKT803018XZA	301
1A168DK01535P6XZA	382	1A168PG03924P7VZA	381	1A180MP0400618XZA	339	1A260DKT803031XZA	301
1A168DK01535P7XZA	382	1A168PG0392461VZA	381	1A180MP0401305XZA	339	1A260DKT803518XZA	301
1A168DK07530P4XZA	382	1A168PM04113P7JZA	381	1A180MP0401318XZA	339	1A260DKT803531XZA	301
1A168DK07530P6XZA	382	1A168PM04113P7LZA	381	1A180MRD17311MZZA	338	1A260DKT810018XZA	295
1A168DK07530P7XZA	382	1A168PM0411361JZA	381	1A180MRD17321MZZA	338	1A260DKT810031XZA	295
1A168DK07535P4XZA	382	1A168PM0411361LZA	381	1A180MRD173105ZZA	338	1A260DKT813018XZA	295
1A168DK07535P6XZA	382	1A168PMD0532P4YZA	380	1A180MRD173118ZZA	338	1A260DKT813031XZA	295
1A168DK07535P7XZA	382	1A168PMD0532P6YZA	380	1A180MRD173205ZZA	338	1A260DKT813518XZA	295
1A168DK07550P4XZA	382	1A168PMD0532P7YZA	380	1A180MRD173218ZZA	338	1A260DKT813531XZA	295
1A168DK07550P6XZA	382	1A168PMD053261YZA	380	1A180PG040241MVZA	339	1A260ID0066318CZA	406
1A168DK07550P7XZA	382	1A168PS03913P7DZA	413	1A180PG0402405VZA	339	1A260ID0066331CZA	406
1A168DK0150061XZA	382	1A168PS0391361DZA	413	1A180PG0402418VZA	339	1A260IPI066318CZA	406
1A168DK0153061XZA	382	1A168RGD1742P4ZZA	380	1A180PM011131MJZA	339	1A260IPI066331CZA	406
1A168DK0153561XZA	382	1A168RGD1742P6ZZA	380	1A180PM011131MLZA	339	1A260IS0066318CZA	406
1A168DK0753061XZA	382	1A168RGD1742P7ZZA	380	1A180PM0111305JZA	339	1A260IS0066331CZA	406
1A168DK0753561XZA	382	1A168RGD174261ZZA	380	1A180PM0111305LZA	339	1A260MR0093118DZA	299
1A168DK0755061XZA	382	1A180CMXX521MCZA	409	1A180PM0111318JZA	339	1A260MR0093131DZA	299
1A168DKC8000P4XZA	383	1A180CMXX5205CZA	409	1A180PM0111318LZA	339	1A260MR0093218DZA	299
1A168DKC8000P6XZA	383	1A180CMXX5218CZA	409	1A180PMD01321MYZA	338	1A260MR0093231DZA	299
1A168DKC8000P7XZA	383	1A180DK015001MXZA	340	1A180PMD013205YZA	338	1A260MR0223118CZA	304
1A168DKC8030P4XZA	383	1A180DK015301MXZA	340	1A180PMD013218YZA	338	1A260MR0223131CZA	304
1A168DKC8030P6XZA	383	1A180DK015351MXZA	340	1A180RGD17421MZZA	338	1A260MR0223218CZA	304
1A168DKC8030P7XZA	383	1A180DK075301MXZA	340	1A180RGD174205ZZA	338	1A260MR0223231CZA	304
1A168DKC8035P4XZA	383	1A180DK075351MXZA	340	1A180RGD174218ZZA	338	1A260MRD173118ZZA	298
1A168DKC8035P6XZA	383	1A180DK075501MXZA	340	1A227CDJ00XX3DXXX	178	1A260MRD173131ZZA	298
1A168DKC8035P7XZA	383	1A180DK0150005XZA	340	1A228CDJ00XX3DXXX	178	1A260MRD173218ZZA	298
1A168DKC800061XZA	383	1A180DK0150018XZA	340	1A260CMXX5218CZA	406	1A260MRD173231ZZA	298
1A168DKC803061XZA	383	1A180DK0153005XZA	340	1A260CMXX5231CZA	406	1A260MRQ093118DZA	293
1A168DKC803561XZA	383	1A180DK0153018XZA	340	1A260DK0150018XZA	300	1A260MRQ093131DZA	293
1A168DKT8000P4XZA	383	1A180DK0153505XZA	340	1A260DK0150031XZA	300	1A260MRQ093218DZA	293
1A168DKT8000P6XZA	383	1A180DK0153518XZA	340	1A260DK0153018XZA	300	1A260MRQ093231DZA	293
1A168DKT8000P7XZA	383	1A180DK0753005XZA	340	1A260DK0153031XZA	300	1A260MRQD73118ZZA	292
1A168DKT8030P4XZA	383	1A180DK0753018XZA	340	1A260DK0153518XZA	300	1A260MRQD73131ZZA	292
1A168DKT8030P6XZA	383	1A180DK0753505XZA	340	1A260DK0153531XZA	300	1A260MRQD73218ZZA	292
1A168DKT8030P7XZA	383	1A180DK0753518XZA	340	1A260DK0753018XZA	300	1A260MRQD73231ZZA	292
1A168DKT8035P4XZA	383	1A180DK0755005XZA	340	1A260DK0753031XZA	300	1A260PMD013218YZA	298
1A168DKT8035P6XZA	383	1A180DK0755018XZA	340	1A260DK0753518XZA	300	1A260PMD013231YZA	298
1A168DKT8035P7XZA	383	1A180DKC80001MXZA	341	1A260DK0753531XZA	300	1A260PMD033218YZA	292
1A168DKT800061XZA	383	1A180DKC80301MXZA	341	1A260DK0755018XZA	300	1A260PMD033231YZA	292
1A168DKT803061XZA	383	1A180DKC80351MXZA	341	1A260DK0755031XZA	300	1A260RG0094218DZA	299
1A168DKT803561XZA	383	1A180DKC800005XZA	341	1A260DKC800018XZA	301	1A260RG0094231DZA	299
1A168ID00663P4CZA	413	1A180DKC800018XZA	341	1A260DKC800031XZA	301	1A260RGD174218ZZA	298
1A168ID00663P6CZA	413	1A180DKC803005XZA	341	1A260DKC803018XZA	301	1A260RGD174231ZZA	298
1A168ID00663P7CZA	413	1A180DKC803018XZA	341	1A260DKC803031XZA	301	1A260RQ0094218DZA	293
1A168ID0066361CZA	413	1A180DKC803505XZA	341	1A260DKC803518XZA	301	1A260RQ0094231DZA	293
1A168IPI0663P4CZA	413	1A180DKC803518XZA	341	1A260DKC803531XZA	301	1A260RQD74218ZZA	292
1A168IPI0663P6CZA	413	1A180DKT80001MXZA	341	1A260DKC810018XZA	295	1A260RQD74231XZA	292

CODE	PAG	CODE	PAG	CODE	PAG	CODE	PAG
1A260RW0224218BZA	304	1A361GF4201346XJA	217	1A483CDJ00XX3DXXX	177	1A711MP7101346XJA	94
1A260RW0224231BZA	304	1A361GF4201505XJA	217	1A485CDJ00XX3DXXX	177	1A711MRJ363105EJA	94
1A307HD31369BQXZA	427	1A361GF4201518XJA	217	1A493CEP39XXANXXA	442	1A711MRJ363146EJA	94
1A307HD313691MXZA	427	1A361GF4201546XJA	217	1A494CDJ00XX3DXXX	177	1A711MRJ363205EJA	94
1A307HD3136947XZA	427	1A370AC3741305DJA	229	1A496CDJ00XX3DXXX	178	1A711MRJ363246EJA	94
1A307HS31300BQXZA	427	1A370AC3741305SJA	229	1A497CDJ00XX3DXXX	178	1A711P7J102405VJA	95
1A307HS31369BQXZA	427	1A370AC3741398DJA	229	1A498CDJ00XX3DXXX	178	1A711P7J102446VJA	95
1A307HS313001MXZA	427	1A370AC3741398SJA	229	1A499CDJ00XX3DXXX	178	1A711PM0611305JJA	95
1A307HS313691MXZA	427	1A370AC3741505DJA	229	1A500CDJ00XX3DXXX	178	1A711PM0611305LJA	95
1A307HS3130047XZA	427	1A370AC3741505SJA	229	1A501CDJ00XX3DXXX	178	1A711PM0611346JJA	95
1A307HS3136947XZA	427	1A370AC3741598DJA	229	1A503N00225218XZA	417	1A711PM0611346LJA	95
1A313PI002XX1MXJA	427	1A370AC3741598SJA	229	1A503N00225231XZA	417	1A711PMJ363205JJA	94
1A313PI002XX05XJA	265	1A371CDJ00XX4CXXX	170	1A511CDJ00XX3DXXX	178	1A711PMJ363205LJA	94
1A313PI002XX18XJA	433	1A371GF3731305XJA	219	1A512CDJ00XX3DXXX	178	1A711PMJ363246JJA	94
1A313PI002XX46XJA	265	1A371GF3731318XJA	219	1A512NOD1752BQXZA	417	1A711PMJ363246LJA	94
1A313PI002XX47XJA	427	1A371GF3731505XJA	219	1A512NOD17521MXZA	417	1A711RJJ364205EJA	94
1A313PI002XXBQXJA	427	1A371GF3731518XJA	219	1A512NOD17528FXZA	417	1A711RJJ364246EJA	94
1A351GF4201305XJA	211	1A371GF3741305DJA	221	1A512NOD175202XZA	417	1A800CMXX521MCZA	406
1A351GF4201346XJA	211	1A371GF3741305SJA	221	1A512NOD175205XZA	417	1A800CMXX528FCZA	406
1A351GF4201398XJA	211	1A371GF3741318DJA	221	1A512NOD175218XZA	417	1A800CMXX5247CZA	406
1A351GF4201505XJA	211	1A371GF3741318SJA	221	1A512NOD175231XZA	417	1A800DK015001MXZA	288
1A351GF4201546XJA	211	1A371GF3741505DJA	221	1A512NOD175243XZA	417	1A800DK015008FXZA	288
1A351GF4201598XJA	211	1A371GF3741505SJA	221	1A512NOD175246XZA	417	1A800DK015301MXZA	288
1A351GF4211305DJA	213	1A371GF3741518DJA	221	1A512NOD175247XZA	417	1A800DK015308FXZA	288
1A351GF4211305SJA	213	1A371GF3741518SJA	221	1A513CDJ00XX3DXXX	178	1A800DK015351MXZA	288
1A351GF4211346DJA	213	1A374CDJ00XX3DXXX	177	1A514CDJ00XX3DXXX	178	1A800DK015358FXZA	288
1A351GF4211346SJA	213	1A375CDJ00XX3DXXX	177	1A515CDJ00XX3DXXX	178	1A800DK075301MXZA	288
1A351GF4211398DJA	213	1A382CDJ00XX3DXXX	177	1A516CDJ00XX3DXXX	178	1A800DK075308FXZA	288
1A351GF4211398SJA	213	1A383CDJ00XX3DXXX	177	1A524CDJ00XX3DXXX	175	1A800DK075351MXZA	288
1A351GF4211505DJA	213	1A401CDJ00XX4CXXX	170	1A525CDJ00XX3DXXX	175	1A800DK075358FXZA	288
1A351GF4211505SJA	213	1A402CDJ00XX4CXXX	170	1A526CDJ00XX3DXXX	175	1A800DK075501MXZA	288
1A351GF4211546DJA	213	1A403CDJ00XX4CXXX	170	1A527CDJ00XX3DXXX	175	1A800DK075508FXZA	288
1A351GF4211546SJA	213	1A404CDJ00XX4CXXX	170	1A528CDJ00XX3DXXX	175	1A800DK0150047XZA	288
1A351GF4211598DJA	213	1A412CDJ00XX5OXXX	251	1A530CDJ00XX3DXXX	176	1A800DK0153047XZA	288
1A351GF4211598SJA	213	1A412CDJ00XX5SXXX	251	1A531CDJ00XX3DXXX	176	1A800DK0153547XZA	288
1A351GF9221305XJA	215	1A412CDJ00XX05XXX	251	1A532CDJ00XX3DXXX	176	1A800DK0753047XZA	288
1A351GF9221346XJA	215	1A412CDJ00XX46XXX	251	1A536PI002XX09XXI	448	1A800DK0753547XZA	288
1A351GF9221398XJA	215	1A413CDJ00XX1MXXX	251	1A592CEXXXANXXA	442	1A800DK0755047XZA	288
1A351GF9221505XJA	215	1A413CDJ00XX05XXX	251	1A710KPXXX0105XJA	165	1A800DKC80001MXZA	289
1A351GF9221546XJA	215	1A413CDJ00XX18XXX	251	1A710KPXXX0146XJA	165	1A800DKC80008FXZA	289
1A351GF9221598XJA	215	1A413CDJ00XX46XXX	251	1A710KPXXX1305XJA	165	1A800DKC80301MXZA	289
1A354AC420131MXJA	225	1A413CDJ00XX98XXX	251	1A710KPXXX1346XJA	165	1A800DKC80308FXZA	289
1A354AC420151MXJA	225	1A427CDJ00XX3DXXX	177	1A710KPXXXB605XJA	165	1A800DKC80351MXZA	289
1A354AC421131MDJA	227	1A431CDJ00XX3DXXX	177	1A710KPXXXB646XJA	165	1A800DKC80358FXZA	289
1A354AC421131MSJA	227	1A432CDJ00XX3DXXX	177	1A711CMXX5205CJA	139	1A800DKC800047XZA	289
1A354AC421151MDJA	227	1A433CDJ00XX3DXXX	175	1A711CMXX5246CJA	139	1A800DKC803047XZA	289
1A354AC421151MSJA	227	1A434CDJ00XX3DXXX	175	1A711DKE690005XJA	95	1A800DKC803547XZA	289
1A354AC4201305XJA	225	1A435CDJ00XX3DXXX	175	1A711DKE690046XJA	95	1A800DKT80001MXZA	289
1A354AC4201346XJA	225	1A436CDJ00XX3DXXX	175	1A711DKE693005XJA	95	1A800DKT80008FXZA	289
1A354AC4201398XJA	225	1A437CDJ00XX3DXXX	175	1A711DKE693046XJA	95	1A800DKT80301MXZA	289
1A354AC4201505XJA	225	1A438CDJ00XX3DXXX	175	1A711DKE693505XJA	95	1A800DKT80308FXZA	289
1A354AC4201546XJA	225	1A439CDJ00XX3DXXX	175	1A711DKE693546XJA	95	1A800DKT80351MXZA	289
1A354AC4201598XJA	225	1A440CDJ00XX3DXXX	175	1A711DKE700005XJA	95	1A800DKT80358FXZA	289
1A354AC4211305DJA	227	1A441CDJ00XX3DXXX	176	1A711DKE700046XJA	95	1A800DKT800047XZA	289
1A354AC4211305SJA	227	1A442CDJ00XX3DXXX	176	1A711DKE703005XJA	95	1A800DKT803047XZA	289
1A354AC4211346DJA	227	1A443CDJ00XX3DXXX	176	1A711DKE703046XJA	95	1A800DKT803547XZA	289
1A354AC4211346SJA	227	1A444CDJ00XX3DXXX	176	1A711DKE703505XJA	95	1A800ID006631MCZA	406
1A354AC4211398DJA	227	1A445CDJ00XX3DXXX	176	1A711DKE703546XJA	95	1A800ID006638FCZA	406
1A354AC4211398SJA	227	1A446CDJ00XX3DXXX	176	1A711ID0065805CJA	139	1A800ID0066347CZA	406
1A354AC4211505DJA	227	1A447CDJ00XX3DXXX	176	1A711ID0065846CJA	139	1A800IPI06631MCZA	406
1A354AC4211505SJA	227	1A463CDJ00XX3DXXX	176	1A711IPI065805CJA	139	1A800IPI06638FCZA	406
1A354AC4211546DJA	227	1A464CDJ00XX3DXXX	176	1A711IPI065846CJA	139	1A800IPI066347CZA	406
1A354AC4211546SJA	227	1A467CDJ00XX3DXXX	176	1A711IS0065805CJA	139	1A800IS006631MCZA	406
1A354AC4211598DJA	227	1A468CDJ00XX3DXXX	176	1A711IS0065846CJA	139	1A800IS006638FCZA	406
1A354AC4211598SJA	227	1A475CDJ00XX3DXXX	177	1A711MP710B605XJA	94	1A800IS0066347CZA	406
1A361GF4201305XJA	217	1A482CDJ00XX3DXXX	170	1A711MP710B646XJA	94	1A800MP040061MDZA	287
1A361GF4201318XJA	217	1A482CDJ00XX3DXXX	170	1A711MP7101305XJA	94	1A800MP040068FDZA	287

CODE	PAG	CODE	PAG	CODE	PAG	CODE	PAG
1A800MP040131MDZA	287	1A900DKT8035BQXZA	273	1A951GF9131505DJA	223	1AJ01BCXXX4518XJA	142
1A800MP040138FDZA	287	1A900DKT80001MXZA	273	1A951GF9131505SJA	223	1AJ01BCXXX4546XJA	142
1A800MP0400647DZA	287	1A900DKT80301MXZA	273	1A951GF9131546DJA	223	1AJ01BCXXX4598XJA	142
1A800MP0401347DZA	287	1A900DKT80351MXZA	273	1A951GF9131546SJA	223	1AJ01BCXXXX5S5XJA	142
1A800MR009311MDZA	286	1A900DKT800047XZA	273	1A951GF9131598DJA	223	1AJ01BCXXXX05XJA	142
1A800MR009318FDZA	286	1A900DKT803047XZA	273	1A951GF9131598SJA	223	1AJ01BCXXXX18XJA	142
1A800MR009321MDZA	286	1A900DKT803547XZA	273	1A952GF914135SDJA	205	1AJ01BCXXXX46XJA	142
1A800MR009328FDZA	286	1A900ID00663BQCZA	404	1A952GF914135SSJA	205	1AJ01BCXXXX98XJA	142
1A800MR0093147DZA	286	1A900ID006631MCZA	404	1A952GF914155SDJA	205	1AJ01BCXXXXK1XJA	142
1A800MR0093247DZA	286	1A900ID0066347CZA	404	1A952GF914155SSJA	205	1AJ01BNXXX45K1XJA	142
1A800MRD17311MZZA	286	1A900IPI0663BQCZA	404	1A952GF9149350DJA	183	1AJ01BNXXX455SXJA	142
1A800MRD17318FZZA	286	1A900IPI06631MCZA	404	1A952GF9149350SJA	183	1AJ01BNXXX4505XJA	142
1A800MRD17321MZZA	286	1A900IPI066347CZA	404	1A952GF914935SDJA	183	1AJ01BNXXX4518XJA	142
1A800MRD17328FZZA	286	1A900IS00663BQCZA	404	1A952GF914935SSJA	183	1AJ01BNXXX4546XJA	142
1A800MRD173147ZZA	286	1A900IS006631MCZA	404	1A952GF9179350XJA	185	1AJ01BNXXX4598XJA	142
1A800MRD173247ZZA	286	1A900IS0066347CZA	404	1A952GF917935SXJA	185	1AJ01BNXXXX5S5XJA	142
1A800PG040241MVZA	287	1A900MP04006BQDZA	271	1A953GF420135SXJA	195	1AJ01BNXXXX05XJA	142
1A800PG040248FVZA	287	1A900MP04013BQDZA	271	1A953GF420155SXJA	195	1AJ01BNXXXX18XJA	142
1A800PG0402447VZA	287	1A900MP040061MDZA	271	1A955GF420135SXJA	197	1AJ01BNXXXX46XJA	142
1A800PM011131MJZA	287	1A900MP040131MDZA	271	1A955GF420155SXJA	197	1AJ01BNXXXX98XJA	142
1A800PM011131MLZA	287	1A900MP0400647DZA	271	1A955GF4201346XJA	197	1AJ01BNXXXXK1XJA	142
1A800PM011138FJZA	287	1A900MP0401347DZA	271	1A955GF4201546XJA	197	1AJ01BYXXX45K1XJA	143
1A800PM011138FLZA	287	1A900MR00931BQDZA	270	1A973GF373135SXJA	207	1AJ01BYXXX455SXJA	143
1A800PM0111347JZA	287	1A900MR00932BQDZA	270	1A973GF373155SXJA	207	1AJ01BYXXX4505XJA	143
1A800PM0111347LZA	287	1A900MR009311MDZA	270	1A973GF3741350DJA	209	1AJ01BYXXX4518XJA	143
1A800PMD01321MYZA	286	1A900MR009321MDZA	270	1A973GF3741350SJA	209	1AJ01BYXXX4546XJA	143
1A800PMD01328FYZA	286	1A900MR0093147DZA	270	1A973GF374135SDJA	209	1AJ01BYXXX4598XJA	143
1A800PMD013247YZA	286	1A900MR0093247DZA	270	1A973GF374135SSJA	209	1AJ01BYXXXG5SXJA	241
1A800RG009421MDZA	286	1A900MRD1731BQZZA	270	1A973GF3741550DJA	209	1AJ01BYXXXG646XJA	241
1A800RG009428FDZA	286	1A900MRD1732BQZZA	270	1A973GF3741550SJA	209	1AJ01BYXXXG698XJA	241
1A800RG0094247DZA	286	1A900MRD17311MZZA	270	1A973GF374155SDJA	209	1AJ01BYXXXX5SXJA	142
1A800RGD17421MZZA	286	1A900MRD17321MZZA	270	1A973GF374155SSJA	209	1AJ01BYXXXX05XJA	142
1A800RGD17428FZZA	286	1A900MRD173147ZZA	270	1A973GF9149350DJA	187	1AJ01BYXXXX18XJA	142
1A800RGD174247ZZA	286	1A900MRD173247ZZA	270	1A973GF9149350SJA	187	1AJ01BYXXXX46XJA	142
1A816MLXXXCP4CXXA	417	1A900PG04024BQVZA	271	1A973GF914935SDJA	187	1AJ01BYXXXX98XJA	142
1A900CMXXX52BQCZA	404	1A900PG040241MVZA	271	1A973GF914935SSJA	187	1AJ01BYXXXXK1XJA	142
1A900CMXXX521MCZA	404	1A900PG0402447VZA	271	1A973GF9179350XJA	189	1AJ01CDXXXX3DXXX	172
1A900CMXXX5247CZA	404	1A900PM01113BQJZA	271	1A973GF917935SXJA	189	1AJ01CMXXX525S5CJA	138
1A900DK01500BQXZA	272	1A900PM01113BQLZA	271	1A973GF3741305DJA	209	1AJ01CMXXX5205CJA	138
1A900DK01530BQXZA	272	1A900PM011131MJZA	271	1A973GF3741305SJA	209	1AJ01CMXXX5246CJA	138
1A900DK01535BQXZA	272	1A900PM011131MLZA	271	1A973GF3741346DJA	209	1AJ01CMXXX5298CJA	138
1A900DK07530BQXZA	272	1A900PM0111347JZA	271	1A973GF3741346SJA	209	1AJ01DKC80005SXJA	90
1A900DK07535BQXZA	272	1A900PM0111347LZA	271	1A973GF3741505DJA	209	1AJ01DKC80305SXJA	90
1A900DK07550BQXZA	272	1A900RG00942BQDZA	270	1A973GF3741505SJA	209	1AJ01DKC80355SXJA	90
1A900DK015001MXZA	272	1A900RG009421MDZA	270	1A973GF3741546DJA	209	1AJ01DKC800005XJA	90
1A900DK015301MXZA	272	1A900RG0094247DZA	270	1A973GF3741546SJA	209	1AJ01DKC800046XJA	90
1A900DK015351MXZA	272	1A900RGD1742BQZZA	270	1A976GF373135SXJA	199	1AJ01DKC800098XJA	90
1A900DK075301MXZA	272	1A900RGD17421MZZA	270	1A976GF373155SXJA	199	1AJ01DKC803005XJA	90
1A900DK075351MXZA	272	1A900RGD174247ZZA	270	1A976GF374135SDJA	201	1AJ01DKC803046XJA	90
1A900DK075501MXZA	272	1A950AC4201305XJA	231	1A976GF374135SSJA	201	1AJ01DKC803098XJA	90
1A900DK0150047XZA	272	1A950AC4201346XJA	231	1A976GF374155SDJA	201	1AJ01DKC803505XJA	90
1A900DK0153047XZA	272	1A950AC4201505XJA	231	1A976GF374155SSJA	201	1AJ01DKC803546XJA	90
1A900DK0153547XZA	272	1A950AC4201546XJA	231	1A976GF3731305XJA	199	1AJ01DKC803598XJA	90
1A900DK0753047XZA	272	1A950AC9131305DJA	233	1A976GF3731505XJA	199	1AJ01DKE66005SXJA	90
1A900DK0753547XZA	272	1A950AC9131305SJA	233	1A976GF3741305DJA	201	1AJ01DKE66305SXJA	90
1A900DK0755047XZA	272	1A950AC9131346DJA	233	1A976GF3741305SJA	201	1AJ01DKE66355SXJA	90
1A900DKC8000BQXZA	273	1A950AC9131346SJA	233	1A976GF3741505DJA	201	1AJ01DKE660005XJA	90
1A900DKC8030BQXZA	273	1A950AC9131505DJA	233	1A976GF3741505SJA	201	1AJ01DKE660046XJA	90
1A900DKC8035BQXZA	273	1A950AC9131505SJA	233	1A982GF9229350XJA	191	1AJ01DKE660098XJA	90
1A900DKC80001MXZA	273	1A950AC9131546DJA	233	1A982GF922935SXJA	191	1AJ01DKE663005XJA	90
1A900DKC80301MXZA	273	1A950AC9131546SJA	233	1A993GF922135SXJA	203	1AJ01DKE663046XJA	90
1A900DKC80351MXZA	273	1A951GF9131305DJA	223	1A993GF922155SXJA	203	1AJ01DKE663098XJA	90
1A900DKC800047XZA	273	1A951GF9131305SJA	223	1AC41SRXXXX5S5XKA	441	1AJ01DKE663505XJA	90
1A900DKC803047XZA	273	1A951GF9131346DJA	223	1AC43SRXXXX5S5XXA	441	1AJ01DKE663546XJA	90
1A900DKC803547XZA	273	1A951GF9131346SJA	223	1AJ01BCXXX45K1XJA	142	1AJ01DKE663598XJA	90
1A900DKT8000BQXZA	273	1A951GF9131398DJA	223	1AJ01BCXXX455SXJA	142	1AJ01DKT80005SXJA	91
1A900DKT8030BQXZA	273	1A951GF9131398SJA	223	1AJ01BCXXX4505XJA	142	1AJ01DKT80305SXJA	91

CODE	PAG	CODE	PAG	CODE	PAG	CODE	PAG
1AJ01DKT80355SXJA	91	1AJ01PFJ01XX46FJA	254	1AJ01RO0FP4518XJA	143	1AJ01WNJ012498XJA	161
1AJ01DKT800005XJA	91	1AJ01PFJ01XX98FJA	254	1AJ01RO0FP4546XJA	143	1AJ01WNJ14241MXJA	162
1AJ01DKT800046XJA	91	1AJ01PI001XX05XZA	434	1AJ01RO0FP4598XJA	143	1AJ01WNJ18241MXJA	163
1AJ01DKT800098XJA	91	1AJ01PI002XX05XZA	434	1AJ01ROXXX45K1XJA	143	1AJ01WNJ032402XJA	161
1AJ01DKT803005XJA	91	1AJ01PJJ012405VJA	89	1AJ01ROXXX455SXJA	143	1AJ01WNJ032405XJA	161
1AJ01DKT803046XJA	91	1AJ01PJJ012446VJA	89	1AJ01ROXXX4505XJA	143	1AJ01WNJ032446XJA	161
1AJ01DKT803098XJA	91	1AJ01PJJ012498VJA	89	1AJ01ROXXX4518XJA	143	1AJ01WNJ032498XJA	161
1AJ01DKT803505XJA	91	1AJ01PLXXX121MXJA	236	1AJ01ROXXX4546XJA	143	1AJ01WNJ122405XJA	162
1AJ01DKT803546XJA	91	1AJ01PLXXX1205XJA	236	1AJ01ROXXX4598XJA	143	1AJ01WNJ122446XJA	162
1AJ01DKT803598XJA	91	1AJ01PLXXX1218XJA	236	1AJ01ROXXXGF5SXJA	240	1AJ01WNJ142405XJA	162
1AJ01FEXXXX02XJA	257	1AJ01PLXXX1246XJA	236	1AJ01ROXXXGF46XJA	240	1AJ01WNJ142446XJA	162
1AJ01FEXXXX05XJA	257	1AJ01PLXXX1298XJA	236	1AJ01ROXXXGF98XJA	240	1AJ01WNJ162446XJA	162
1AJ01ID006585SCJA	138	1AJ01PMJ03325SJJJA	88	1AJ01ROXXXX5SXJA	143	1AJ01WNJ182405XJA	163
1AJ01ID0065805CJA	138	1AJ01PMJ03325SLJA	88	1AJ01ROXXXXX05XJA	143	1AJ01WNJ182446XJA	163
1AJ01ID0065846CJA	138	1AJ01PMJ011305JJA	89	1AJ01ROXXXXX18XXA	143	1AJ01WNJ352405XJA	163
1AJ01ID0065898CJA	138	1AJ01PMJ011305LJA	89	1AJ01ROXXXXX46XJA	143	1AJ01WNJ352498XJA	163
1AJ01IPI06585SCJA	138	1AJ01PMJ011346JJA	89	1AJ01ROXXXXX98XJA	143	1AJ02CDXXXX3DXXX	172
1AJ01IPI065805CJA	138	1AJ01PMJ011346LJA	89	1AJ01ROXXXXXK1XJA	143	1AJ02CMXXX5231CZA	412
1AJ01IPI065846CJA	138	1AJ01PMJ011398JJA	89	1AJ01SPJ1852K1XJA	158	1AJ02CMXXX5243CZA	412
1AJ01IPI065898CJA	138	1AJ01PMJ011398LJA	89	1AJ01SPJ035250XJA	157	1AJ02DK0150031DZA	371
1AJ01IS006585SCJA	138	1AJ01PMJ033205JJA	88	1AJ01SPJ03525SXJA	157	1AJ02DK0150031SZA	371
1AJ01IS0065805CJA	138	1AJ01PMJ033205LJA	88	1AJ01SPJ03528BXJA	157	1AJ02DK0150043DZA	371
1AJ01IS0065846CJA	138	1AJ01PMJ033246JJA	88	1AJ01SPJ13528BXJA	157	1AJ02DK0150043SZA	371
1AJ01IS0065898CJA	138	1AJ01PMJ033246LJA	88	1AJ01SPJ035205XJA	157	1AJ02DK0153031DZA	371
1AJ01KPXXX0105XJA	165	1AJ01PMJ033298JJA	88	1AJ01SPJ035246XJA	157	1AJ02DK0153031SZA	371
1AJ01KPXXX0146XJA	165	1AJ01PMJ033298LJA	88	1AJ01SPJ035298XJA	157	1AJ02DK0153043DZA	371
1AJ01KPXXX0198XJA	165	1AJ01PQXXX6605XJA	254	1AJ01SPJ36521MXJA	158	1AJ02DK0153043SZA	371
1AJ01KPXXX1305XJA	165	1AJ01PQXXX6646XJA	254	1AJ01SPJ36528BXJA	158	1AJ02DK0153531DZA	371
1AJ01KPXXX1346XJA	165	1AJ01PQXXX6698XJA	254	1AJ01SPJ135205XJA	157	1AJ02DK0153531SZA	371
1AJ01KPXXX1398XJA	165	1AJ01RIJ0452K1XJA	159	1AJ01SPJ135246XJA	157	1AJ02DK0153543DZA	371
1AJ01KPXXXB605XJA	165	1AJ01RIJ01525SXJA	159	1AJ01SPJ185205XJA	158	1AJ02DK0153543SZA	371
1AJ01KPXXXB646XJA	165	1AJ01RIJ1852K1XJA	158	1AJ01SPJ185246XJA	158	1AJ02DKC800031DZA	372
1AJ01KPXXXB698XJA	165	1AJ01RIJ3052K1XJA	160	1AJ01SPJ365205XJA	158	1AJ02DKC800031SZA	372
1AJ01MLXXX454CXXX	171	1AJ01RIJ035250XJA	157	1AJ01SPJ365246XJA	158	1AJ02DKC800043DZA	372
1AJ01MLXXXX4CXXX	171	1AJ01RIJ03525SXJA	157	1AJ01SPJ365298XJA	158	1AJ02DKC800043SZA	372
1AJ01MPJ01B605XJA	88	1AJ01RIJ03528BXJA	157	1AJ01WI7102405XJA	161	1AJ02DKC803031DZA	372
1AJ01MPJ01B646XJA	88	1AJ01RIJ13528BXJA	157	1AJ01WI7102446XJA	161	1AJ02DKC803031SZA	372
1AJ01MPJ01B698XJA	88	1AJ01RIJ015205XJA	159	1AJ01WIJ0424K1XJA	164	1AJ02DKC803043DZA	372
1AJ01MPJ011305XJA	88	1AJ01RIJ015218XJA	159	1AJ01WIJ03248BXJA	161	1AJ02DKC803043SZA	372
1AJ01MPJ011346XJA	88	1AJ01RIJ30525SXJA	160	1AJ01WIJ12248BXJA	162	1AJ02DKC803531DZA	372
1AJ01MPJ011398XJA	88	1AJ01RIJ035205XJA	157	1AJ01WIJ012405XJA	161	1AJ02DKC803531SZA	372
1AJ01MRJ03315SEJA	88	1AJ01RIJ035246XJA	157	1AJ01WIJ012446XJA	161	1AJ02DKC803543DZA	372
1AJ01MRJ03325SEJA	88	1AJ01RIJ035298XJA	157	1AJ01WIJ012498XJA	161	1AJ02DKC803543SZA	372
1AJ01MRJ033105EJA	88	1AJ01RIJ36521MXJA	158	1AJ01WIJ14241MXJA	162	1AJ02DKT800031DZA	373
1AJ01MRJ033146EJA	88	1AJ01RIJ36528BXJA	158	1AJ01WIJ18241MXJA	163	1AJ02DKT800031SZA	373
1AJ01MRJ033198EJA	88	1AJ01RIJ37525SXJA	160	1AJ01WIJ032402XJA	161	1AJ02DKT800043DZA	373
1AJ01MRJ033205EJA	88	1AJ01RIJ045205XJA	159	1AJ01WIJ032405XJA	161	1AJ02DKT800043SZA	373
1AJ01MRJ033246EJA	88	1AJ01RIJ045246XJA	159	1AJ01WIJ032446XJA	161	1AJ02DKT803031DZA	373
1AJ01MRJ033298EJA	88	1AJ01RIJ045298XJA	159	1AJ01WIJ032498XJA	161	1AJ02DKT803031SZA	373
1AJ01NOJ1852K1XJA	158	1AJ01RIJ135205XJA	157	1AJ01WIJ042405XJA	164	1AJ02DKT803043DZA	373
1AJ01NOJ035250XJA	157	1AJ01RIJ135246XJA	157	1AJ01WIJ042446XJA	164	1AJ02DKT803043SZA	373
1AJ01NOJ03525SXJA	157	1AJ01RIJ185205XJA	158	1AJ01WIJ042498XJA	164	1AJ02DKT803531DZA	373
1AJ01NOJ03528BXJA	157	1AJ01RIJ185246XJA	158	1AJ01WIJ122405XJA	162	1AJ02DKT803531SZA	373
1AJ01NOJ13528BXJA	157	1AJ01RIJ305205XJA	160	1AJ01WIJ122446XJA	162	1AJ02DKT803543DZA	373
1AJ01NOJ035205XJA	157	1AJ01RIJ305218XJA	160	1AJ01WIJ142405XJA	162	1AJ02DKT803543SZA	373
1AJ01NOJ035246XJA	157	1AJ01RIJ365205XJA	158	1AJ01WIJ142446XJA	162	1AJ02FEXXXX05XJA	257
1AJ01NOJ035298XJA	157	1AJ01RIJ365246XJA	158	1AJ01WIJ162446XJA	162	1AJ02ID0066331CZA	412
1AJ01NOJ36521MXJA	158	1AJ01RIJ365298XJA	158	1AJ01WIJ182405XJA	163	1AJ02ID0066343CZA	412
1AJ01NOJ36528BXJA	158	1AJ01RIJ375205XJA	160	1AJ01WIJ182446XJA	163	1AJ02IDI066331CZA	412
1AJ01NOJ135205XJA	157	1AJ01RIJ375218XJA	160	1AJ01WIJ352405XJA	163	1AJ02IDI066343CZA	412
1AJ01NOJ135246XJA	157	1AJ01RJJ03425SEJA	88	1AJ01WIJ352498XJA	163	1AJ02IS0066331CZA	412
1AJ01NOJ185205XJA	158	1AJ01RJJ034205EJA	88	1AJ01WN7102405XJA	161	1AJ02IS0066343CZA	412
1AJ01NOJ185246XJA	158	1AJ01RJJ034246EJA	88	1AJ01WN7102446XJA	161	1AJ02IS0066331CZA	412
1AJ01NOJ365205XJA	158	1AJ01RJJ034298EJA	88	1AJ01WNJ03248BXJA	161	1AJ02ISI066343CZA	412
1AJ01NOJ365246XJA	158	1AJ01RO0FP45K1XJA	143	1AJ01WNJ12248BXJA	162	1AJ02MRD173131ZZA	370
1AJ01NOJ365298XJA	158	1AJ01RO0FP455SXJA	143	1AJ01WNJ012405XJA	161	1AJ02MRD173143ZZA	370
1AJ01PFJ01XX05FJA	254	1AJ01RO0FP4505XJA	143	1AJ01WNJ012446XJA	161	1AJ02MRD173231ZZA	370

CODE	PAG
1AJ02MRD173243ZZA	370
1AJ02NOJ0452K1XJA	159
1AJ02NOJ01525SXJA	159
1AJ02NOJ3052K1XJA	160
1AJ02NOJ015205XJA	159
1AJ02NOJ015218XJA	159
1AJ02NOJ30525SXJA	160
1AJ02NOJ37525SXJA	160
1AJ02NOJ045205XJA	159
1AJ02NOJ045246XJA	159
1AJ02NOJ045298XJA	159
1AJ02NOJ305205XJA	160
1AJ02NOJ305218XJA	160
1AJ02NOJ375205XJA	160
1AJ02NOJ375218XJA	160
1AJ02PFJ01XX46FJA	255
1AJ02PI001XX02XZA	434
1AJ02PI001XX5SXZA	434
1AJ02PI001XX05XZA	434
1AJ02PI002XX02XZA	434
1AJ02PI002XX5SXZA	434
1AJ02PI002XX05XZA	434
1AJ02PLXXX1205XJA	236
1AJ02PLXXX1246XJA	236
1AJ02PLXXX1298XJA	236
1AJ02PMD013231JZA	370
1AJ02PMD013231LZA	370
1AJ02PMD013243JZA	370
1AJ02PMD013243LZA	370
1AJ02PQXXX6605XJA	255
1AJ02PQXXX6646XJA	255
1AJ02RGD174231ZZA	370
1AJ02RGD174243ZZA	370
1AJ02SPJ0452K1XJA	159
1AJ02SPJ01525SXJA	159
1AJ02SPJ015205XJA	159
1AJ02SPJ015218XJA	159
1AJ02SPJ30525SXJA	160
1AJ02SPJ37525SXJA	160
1AJ02SPJ045205XJA	159
1AJ02SPJ045246XJA	159
1AJ02SPJ045298XJA	159
1AJ02SPJ305205XJA	160
1AJ02SPJ305218XJA	160
1AJ02SPJ375205XJA	160
1AJ02SPJ375218XJA	160
1AJ02WNJ0424K1XJA	164
1AJ02WNJ042405XJA	164
1AJ02WNJ042446XJA	164
1AJ02WNJ042498XJA	164
1AJ03BCXXX4550XJA	144
1AJ03BCXXX455SXJA	144
1AJ03BCXXX458BXJA	144
1AJ03BCXXX4505XJA	144
1AJ03BCXXX4546XJA	144
1AJ03BCXXX4598XJA	144
1AJ03BCXXX50XJA	144
1AJ03BCXXXXX5SXJA	144
1AJ03BCXXXXX05XJA	144
1AJ03BCXXXXX8BXJA	144
1AJ03BCXXXXX46XJA	144
1AJ03BCXXXXX98XJA	144
1AJ03BNXXX4550XJA	144
1AJ03BNXXX455SXJA	144
1AJ03BNXXX458BXJA	144
1AJ03BNXXX4505XJA	144
1AJ03BNXXX4546XJA	144

CODE	PAG
1AJ03BNXXX4598XJA	144
1AJ03BNXXXXX50XJA	144
1AJ03BNXXXXX5SXJA	144
1AJ03BNXXXXX05XJA	144
1AJ03BNXXXXX8BXJA	144
1AJ03BNXXXXX46XJA	144
1AJ03BNXXXXX98XJA	144
1AJ03BYXXX4550XJA	145
1AJ03BYXXX455SXJA	145
1AJ03BYXXX458BXJA	145
1AJ03BYXXX4505XJA	145
1AJ03BYXXX4546XJA	145
1AJ03BYXXX4598XJA	145
1AJ03BYXXXGF5SXJA	241
1AJ03BYXXXXX50XJA	144
1AJ03BYXXXXX5SXJA	144
1AJ03BYXXXXX05XJA	144
1AJ03BYXXXXX8BXJA	144
1AJ03BYXXXXX46XJA	144
1AJ03BYXXXXX98XJA	144
1AJ03CDXXXXX3DXXX	172
1AJ03CMXXX528BCJA	136
1AJ03CMXXX5205CJA	136
1AJ03CMXXX5246CJA	136
1AJ03CMXXX5298CJA	136
1AJ03DKC80008BXJA	57
1AJ03DKC80308BXJA	57
1AJ03DKC80358BXJA	57
1AJ03DKC800005XJA	57
1AJ03DKC800046XJA	57
1AJ03DKC800098XJA	57
1AJ03DKC803005XJA	57
1AJ03DKC803046XJA	57
1AJ03DKC803098XJA	57
1AJ03DKC803505XJA	57
1AJ03DKC803546XJA	57
1AJ03DKC803598XJA	57
1AJ03DKE66008BXJA	55
1AJ03DKE66308BXJA	55
1AJ03DKE66358BXJA	55
1AJ03DKE69008BXJA	56
1AJ03DKE69308BXJA	56
1AJ03DKE69358BXJA	56
1AJ03DKE70008BXJA	56
1AJ03DKE70308BXJA	56
1AJ03DKE70358BXJA	56
1AJ03DKE660005XJA	55
1AJ03DKE660046XJA	55
1AJ03DKE660098XJA	55
1AJ03DKE663005XJA	55
1AJ03DKE663046XJA	55
1AJ03DKE663098XJA	55
1AJ03DKE663505XJA	55
1AJ03DKE663546XJA	55
1AJ03DKE663598XJA	55
1AJ03DKE690005XJA	56
1AJ03DKE690046XJA	56
1AJ03DKE690098XJA	56
1AJ03DKE693005XJA	56
1AJ03DKE693046XJA	56
1AJ03DKE693098XJA	56
1AJ03DKE693505XJA	56
1AJ03DKE693546XJA	56
1AJ03DKE693598XJA	56
1AJ03DKE700005XJA	56
1AJ03DKE700046XJA	56
1AJ03DKE700098XJA	56

CODE	PAG
1AJ03DKE703005XJA	56
1AJ03DKE703046XJA	56
1AJ03DKE703098XJA	56
1AJ03DKE703505XJA	56
1AJ03DKE703546XJA	56
1AJ03DKE703598XJA	56
1AJ03DKT80008BXJA	57
1AJ03DKT80308BXJA	57
1AJ03DKT80358BXJA	57
1AJ03DKT800005XJA	57
1AJ03DKT800046XJA	57
1AJ03DKT800098XJA	57
1AJ03DKT803005XJA	57
1AJ03DKT803046XJA	57
1AJ03DKT803098XJA	57
1AJ03DKT803505XJA	57
1AJ03DKT803546XJA	57
1AJ03DKT803598XJA	57
1AJ03ID006588BCJA	136
1AJ03ID0065805CJA	136
1AJ03ID0065846CJA	136
1AJ03ID0065898CJA	136
1AJ03ID0065898CJA	136
1AJ03IPI06588BCJA	136
1AJ03IPI065805CJA	136
1AJ03IPI065846CJA	136
1AJ03IPI065898CJA	136
1AJ03IS006588BCJA	136
1AJ03IS0065805CJA	136
1AJ03IS0065846CJA	136
1AJ03IS0065898CJA	136
1AJ03KP0FP158BXJA	166
1AJ03KP0FP1502XJA	166
1AJ03KP0FP1505XJA	166
1AJ03KP0FP1546XJA	166
1AJ03KP0FP1598XJA	166
1AJ03KPXXX018BXJA	166
1AJ03KPXXX0102XJA	166
1AJ03KPXXX0105XJA	166
1AJ03KPXXX138BXJA	166
1AJ03KPXXX0146XJA	166
1AJ03KPXXX0198XJA	166
1AJ03KPXXX1302XJA	166
1AJ03KPXXX1305XJA	166
1AJ03KPXXX1346XJA	166
1AJ03KPXXX1398XJA	166
1AJ03KPXXXB68BXJA	166
1AJ03KPXXXB602XJA	166
1AJ03KPXXXB605XJA	166
1AJ03KPXXXB646XJA	166
1AJ03KPXXXB698XJA	166
1AJ03MPJ03B68BXJA	54
1AJ03MPJ03B605XJA	54
1AJ03MPJ03B646XJA	54
1AJ03MPJ03B698XJA	54
1AJ03MPJ03138BXJA	54
1AJ03MPJ031305XJA	54
1AJ03MPJ031346XJA	54
1AJ03MPJ031398XJA	54
1AJ03MRJ03318BEJA	54
1AJ03MRJ03328BEJA	54
1AJ03MRJ033105EJA	54
1AJ03MRJ033146EJA	54
1AJ03MRJ033198EJA	54
1AJ03MRJ033205EJA	54
1AJ03MRJ033246EJA	54
1AJ03MRJ033298EJA	54
1AJ03PFJ30XX05FJA	256

CODE	PAG
1AJ03PFJ30XX18FJA	256
1AJ03PFJ30XX46FJA	256
1AJ03PI001XX02XZA	434
1AJ03PI001XX05XZA	434
1AJ03PI002XX02XZA	434
1AJ03PI002XX05XZA	434
1AJ03PI011XX02XZA	434
1AJ03PI011XX05XZA	434
1AJ03PJ03248BVJA	55
1AJ03PJ032405VJA	55
1AJ03PJ032446VJA	55
1AJ03PJ032498VJA	55
1AJ03PLXXX1205XJA	237
1AJ03PLXXX1218XJA	237
1AJ03PLXXX1298XJA	237
1AJ03PMJ03328BJJA	54
1AJ03PMJ03328BLJA	54
1AJ03PMJ13138BJJA	55
1AJ03PMJ13138BLJA	55
1AJ03PMJ033205JJA	54
1AJ03PMJ033205LJA	54
1AJ03PMJ033246JJA	54
1AJ03PMJ033246LJA	54
1AJ03PMJ033298JJA	54
1AJ03PMJ033298LJA	54
1AJ03PMJ131305JJA	55
1AJ03PMJ131305LJA	55
1AJ03PMJ131346JJA	55
1AJ03PMJ131346LJA	55
1AJ03PMJ131398JJA	55
1AJ03PMJ131398LJA	55
1AJ03PQXXX6605XJA	256
1AJ03PQXXX6618XJA	256
1AJ03RJ03428BEJA	54
1AJ03RJ034205EJA	54
1AJ03RJ034246EJA	54
1AJ03RJ034298EJA	54
1AJ03RO0FP458BXJA	145
1AJ03RO0FP4505XJA	145
1AJ03RO0FP4546XJA	145
1AJ03RO0FP4598XJA	145
1AJ03ROXXX4550XJA	145
1AJ03ROXXX455SXJA	145
1AJ03ROXXX458BXJA	145
1AJ03ROXXX4505XJA	145
1AJ03ROXXX4546XJA	145
1AJ03ROXXX4598XJA	145
1AJ03ROXXXGF5SXJA	240
1AJ03ROXXXXX50XJA	145
1AJ03ROXXXXX5SXJA	145
1AJ03ROXXXXX05XJA	145
1AJ03ROXXXXX8BXJA	145
1AJ03ROXXXXX46XJA	145
1AJ03ROXXXXX98XJA	145
1AJ04BCXXX45K1XJA	146
1AJ04BCXXX4505XJA	146
1AJ04BCXXX4546XJA	146
1AJ04BCXXX4598XJA	146
1AJ04BCXXXXX05XJA	146
1AJ04BCXXXXX46XJA	146
1AJ04BCXXXXX98XJA	146
1AJ04BCXXXXXK1XJA	146
1AJ04BNXXX4505XJA	146
1AJ04BNXXX4546XJA	146
1AJ04BNXXX4598XJA	146
1AJ04BNXXXXX05XJA	146

CODE	PAG	CODE	PAG	CODE	PAG	CODE	PAG
1AJ04BNXXXX46XJA	146	1AJ04DKE70355SXJA	36	1AJ04DKT813505XJA	27	1AJ04KPXXXB646XJA	169
1AJ04BNXXXX98XJA	146	1AJ04DKE82005SXJA	26	1AJ04DKT813518XJA	27	1AJ04KPXXXB698XJA	169
1AJ04BNXXXXK1XJA	146	1AJ04DKE82305SXJA	26	1AJ04DKT813546XJA	27	1AJ04MAJQ65105XJA	31
1AJ04BYXXX45K1XJA	147	1AJ04DKE82355SXJA	26	1AJ04HDQ1369K1XJA	261	1AJ04MAJQ65146XJA	31
1AJ04BYXXX4505XJA	147	1AJ04DKE660005XJA	35	1AJ04HDQ136905XJA	261	1AJ04MPJ04B6K1XJA	30
1AJ04BYXXX4546XJA	147	1AJ04DKE660018XJA	35	1AJ04HDQ136918XJA	261	1AJ04MPJ04B65SXJA	30
1AJ04BYXXX4598XJA	147	1AJ04DKE660046XJA	35	1AJ04HDQ136946XJA	261	1AJ04MPJ04B605XJA	30
1AJ04BYXXX05XJA	146	1AJ04DKE663005XJA	35	1AJ04HDQ136998XJA	261	1AJ04MPJ04B646XJA	30
1AJ04BYXXX46XJA	146	1AJ04DKE663018XJA	35	1AJ04HSQ1300K1XJA	261	1AJ04MPJ0413K1XJA	30
1AJ04BYXXXXX98XJA	146	1AJ04DKE663046XJA	35	1AJ04HSQ1369K1XJA	261	1AJ04MPJ04135SXJA	30
1AJ04BYXXXXXK1XJA	146	1AJ04DKE663505XJA	35	1AJ04HSQ130005XJA	261	1AJ04MPJ041305XJA	30
1AJ04CDXXXX3DXXX	172	1AJ04DKE663518XJA	35	1AJ04HSQ130018XJA	261	1AJ04MPJ041346XJA	30
1AJ04CMXXX52K1CJA	134	1AJ04DKE663546XJA	35	1AJ04HSQ130046XJA	261	1AJ04MRJ0131K1EJA	34
1AJ04CMXXX525SCJA	134	1AJ04DKE690005XJA	35	1AJ04HSQ130098XJA	261	1AJ04MRJ0132K1EJA	34
1AJ04CMXXX5205CJA	134	1AJ04DKE690018XJA	35	1AJ04HSQ136905XJA	261	1AJ04MRJ0431K1EJA	30
1AJ04CMXXX5218CJA	134	1AJ04DKE690046XJA	35	1AJ04HSQ136918XJA	261	1AJ04MRJ0432K1EJA	30
1AJ04CMXXX5246CJA	134	1AJ04DKE693005XJA	35	1AJ04HSQ136946XJA	261	1AJ04MRJ01315SEJA	34
1AJ04DKC8000K1XJA	36	1AJ04DKE693018XJA	35	1AJ04HSQ136998XJA	261	1AJ04MRJ01325SEJA	34
1AJ04DKC8030K1XJA	36	1AJ04DKE693046XJA	35	1AJ04ID00658K1CJA	134	1AJ04MRJ3031K1EJA	26
1AJ04DKC8035K1XJA	36	1AJ04DKE693505XJA	35	1AJ04ID0065805CJA	134	1AJ04MRJ3032K1EJA	26
1AJ04DKC8100K1XJA	27	1AJ04DKE693518XJA	35	1AJ04ID0065818CJA	134	1AJ04MRJ04315SEJA	30
1AJ04DKC8130K1XJA	27	1AJ04DKE693546XJA	35	1AJ04ID0065846CJA	134	1AJ04MRJ04325SEJA	30
1AJ04DKC8135K1XJA	27	1AJ04DKE700005XJA	36	1AJ04IPI0658K1CJA	134	1AJ04MRJ013105EJA	34
1AJ04DKC80005SXJA	36	1AJ04DKE700018XJA	36	1AJ04IPI06585SCJA	134	1AJ04MRJ013118EJA	34
1AJ04DKC80305SXJA	36	1AJ04DKE700046XJA	36	1AJ04IPI065805CJA	134	1AJ04MRJ013146EJA	34
1AJ04DKC80355SXJA	36	1AJ04DKE703005XJA	36	1AJ04IPI065818CJA	134	1AJ04MRJ013205EJA	34
1AJ04DKC81005SXJA	27	1AJ04DKE703018XJA	36	1AJ04IPI065846CJA	134	1AJ04MRJ013218EJA	34
1AJ04DKC81305SXJA	27	1AJ04DKE703046XJA	36	1AJ04IS00658K1CJA	134	1AJ04MRJ013246EJA	34
1AJ04DKC81355SXJA	27	1AJ04DKE703505XJA	36	1AJ04IS0065805CJA	134	1AJ04MRJ30315SEJA	26
1AJ04DKC800005XJA	36	1AJ04DKE703518XJA	36	1AJ04IS0065818CJA	134	1AJ04MRJ30325SEJA	26
1AJ04DKC800018XJA	36	1AJ04DKE703546XJA	36	1AJ04IS0065846CJA	134	1AJ04MRJ043105EJA	30
1AJ04DKC800046XJA	36	1AJ04DKE820005XJA	26	1AJ04JPJ0424K1VJA	31	1AJ04MRJ043146EJA	30
1AJ04DKC803005XJA	36	1AJ04DKE820018XJA	26	1AJ04JPJ04245SVJA	31	1AJ04MRJ043205EJA	30
1AJ04DKC803018XJA	36	1AJ04DKE820046XJA	26	1AJ04JPJ042405VJA	31	1AJ04MRJ043246EJA	30
1AJ04DKC803046XJA	36	1AJ04DKE823005XJA	26	1AJ04JPJ042446VJA	31	1AJ04MRJ303105EJA	26
1AJ04DKC803505XJA	36	1AJ04DKE823018XJA	26	1AJ04JRJ0142K1EJA	34	1AJ04MRJ303118EJA	26
1AJ04DKC803518XJA	36	1AJ04DKE823046XJA	26	1AJ04JRJ0442K1EJA	30	1AJ04MRJ303146EJA	26
1AJ04DKC803546XJA	36	1AJ04DKE823505XJA	26	1AJ04JRJ01425SEJA	34	1AJ04MRJ303205EJA	26
1AJ04DKC810005XJA	27	1AJ04DKE823518XJA	26	1AJ04JRJ3042K1EJA	26	1AJ04MRJ303218EJA	26
1AJ04DKC810018XJA	27	1AJ04DKE823546XJA	26	1AJ04JRJ04425SEJA	30	1AJ04MRJ303246EJA	26
1AJ04DKC810046XJA	27	1AJ04DKT8000K1XJA	37	1AJ04JRJ014205EJA	34	1AJ04PLXXX125SXJA	237
1AJ04DKC813005XJA	27	1AJ04DKT8030K1XJA	37	1AJ04JRJ014218EJA	34	1AJ04PMJ2032K1JJA	34
1AJ04DKC813018XJA	27	1AJ04DKT8035K1XJA	37	1AJ04JRJ014246EJA	34	1AJ04PMJ2032K1LJA	34
1AJ04DKC813046XJA	27	1AJ04DKT8100K1XJA	27	1AJ04JRJ30425SEJA	26	1AJ04PMJ3032K1JJA	26
1AJ04DKC813505XJA	27	1AJ04DKT8130K1XJA	27	1AJ04JRJ044205EJA	30	1AJ04PMJ3032K1LJA	26
1AJ04DKC813518XJA	27	1AJ04DKT8135K1XJA	27	1AJ04JRJ044246EJA	30	1AJ04PMJ3313K1JJA	31
1AJ04DKC813546XJA	27	1AJ04DKT80005SXJA	37	1AJ04JRJ304205EJA	26	1AJ04PMJ3313K1LJA	31
1AJ04DKE6600K1XJA	35	1AJ04DKT80305SXJA	37	1AJ04JRJ304218EJA	26	1AJ04PMJ3432K1JJA	30
1AJ04DKE6630K1XJA	35	1AJ04DKT80355SXJA	37	1AJ04JRJ304246EJA	26	1AJ04PMJ3432K1LJA	30
1AJ04DKE6635K1XJA	35	1AJ04DKT81005SXJA	27	1AJ04KP0FP15K1XJA	169	1AJ04PMJ20325SJJJA	34
1AJ04DKE6900K1XJA	35	1AJ04DKT81305SXJA	27	1AJ04KP0FP1505XJA	169	1AJ04PMJ20325SLJA	34
1AJ04DKE6930K1XJA	35	1AJ04DKT81355SXJA	27	1AJ04KP0FP1518XJA	169	1AJ04PMJ30325SJJJA	26
1AJ04DKE6935K1XJA	35	1AJ04DKT800005XJA	37	1AJ04KP0FP1546XJA	169	1AJ04PMJ30325SLJA	26
1AJ04DKE7000K1XJA	36	1AJ04DKT800018XJA	37	1AJ04KP0FP1598XJA	169	1AJ04PMJ33135SJJJA	31
1AJ04DKE7030K1XJA	36	1AJ04DKT800046XJA	37	1AJ04KPXXX01K1XJA	169	1AJ04PMJ33135SLJA	31
1AJ04DKE7035K1XJA	36	1AJ04DKT803005XJA	37	1AJ04KPXXX13K1XJA	169	1AJ04PMJ34325SJJJA	30
1AJ04DKE8200K1XJA	26	1AJ04DKT803018XJA	37	1AJ04KPXXX0105XJA	169	1AJ04PMJ34325SLJA	30
1AJ04DKE8230K1XJA	26	1AJ04DKT803046XJA	37	1AJ04KPXXX0118XJA	169	1AJ04PMJ203205JJA	34
1AJ04DKE8235K1XJA	26	1AJ04DKT803505XJA	37	1AJ04KPXXX0146XJA	169	1AJ04PMJ203205LJA	34
1AJ04DKE66005SXJA	35	1AJ04DKT803518XJA	37	1AJ04KPXXX0198XJA	169	1AJ04PMJ203218JJA	34
1AJ04DKE66305SXJA	35	1AJ04DKT803546XJA	37	1AJ04KPXXX1305XJA	169	1AJ04PMJ203218LJA	34
1AJ04DKE66355SXJA	35	1AJ04DKT810005XJA	27	1AJ04KPXXX1318XJA	169	1AJ04PMJ203246JJA	34
1AJ04DKE69005SXJA	35	1AJ04DKT810018XJA	27	1AJ04KPXXX1346XJA	169	1AJ04PMJ203246LJA	34
1AJ04DKE69305SXJA	35	1AJ04DKT810046XJA	27	1AJ04KPXXX1398XJA	169	1AJ04PMJ303205JJA	26
1AJ04DKE69355SXJA	35	1AJ04DKT813005XJA	27	1AJ04KPXXXB6K1XJA	169	1AJ04PMJ303205LJA	26
1AJ04DKE70005SXJA	36	1AJ04DKT813018XJA	27	1AJ04KPXXXB605XJA	169	1AJ04PMJ303218JJA	26
1AJ04DKE70305SXJA	36	1AJ04DKT813046XJA	27	1AJ04KPXXXB618XJA	169	1AJ04PMJ303218LJA	26

CODE	PAG	CODE	PAG	CODE	PAG	CODE	PAG
1AJ04PMJ303246JJA	26	1AJ06DKC80305ESZA	388	1AJ07DKT80305EXZA	363	1AJ12DKC80008BXJA	42
1AJ04PMJ303246LJA	26	1AJ06DKC80355EDZA	388	1AJ07DKT80355EXZA	363	1AJ12DKC80308BXJA	42
1AJ04PMJ331305JJA	31	1AJ06DKC80355ESZA	388	1AJ07DKT800026XZA	363	1AJ12DKC80358BXJA	42
1AJ04PMJ331305LJA	31	1AJ06DKT8000F6DZA	389	1AJ07DKT803026XZA	363	1AJ12DKC800005XJA	42
1AJ04PMJ331346JJA	31	1AJ06DKT8000F6SZA	389	1AJ07DKT803526XZA	363	1AJ12DKC800046XJA	42
1AJ04PMJ331346LJA	31	1AJ06DKT8030F6DZA	389	1AJ07ID00663F6CZA	411	1AJ12DKC803005XJA	42
1AJ04PMJ343205JJA	30	1AJ06DKT8030F6SZA	389	1AJ07ID006635ECZA	411	1AJ12DKC803046XJA	42
1AJ04PMJ343205LJA	30	1AJ06DKT8035F6DZA	389	1AJ07ID0066326CZA	411	1AJ12DKC803505XJA	42
1AJ04PMJ343246JJA	30	1AJ06DKT8035F6SZA	389	1AJ07IPI0663F6CZA	411	1AJ12DKC803546XJA	42
1AJ04PMJ343246LJA	30	1AJ06DKT80005EDZA	389	1AJ07IPI06635ECZA	411	1AJ12DKE69008BXJA	41
1AJ04RO0FP45K1XJA	147	1AJ06DKT80005ESZA	389	1AJ07IPI066326CZA	411	1AJ12DKE69308BXJA	41
1AJ04RO0FP4505XJA	147	1AJ06DKT80305EDZA	389	1AJ07IS00663F6CZA	411	1AJ12DKE69358BXJA	41
1AJ04RO0FP4546XJA	147	1AJ06DKT80305ESZA	389	1AJ07IS006635ECZA	411	1AJ12DKE70008BXJA	42
1AJ04RO0FP4598XJA	147	1AJ06DKT80355EDZA	389	1AJ07IS0066326CZA	411	1AJ12DKE70308BXJA	42
1AJ04ROXXX45K1XJA	147	1AJ06DKT80355ESZA	389	1AJ07MRD1731F6ZZA	362	1AJ12DKE70358BXJA	42
1AJ04ROXXX4505XJA	147	1AJ06ID00618F6CZA	414	1AJ07MRD1732F6ZZA	362	1AJ12DKE690005XJA	41
1AJ04ROXXX4546XJA	147	1AJ06ID006185ECZA	414	1AJ07MRD17315EZZA	362	1AJ12DKE690046XJA	41
1AJ04ROXXX4598XJA	147	1AJ06IS00618F6CZA	414	1AJ07MRD17325EZZA	362	1AJ12DKE693005XJA	41
1AJ04ROXXXXX05XJA	147	1AJ06IS006185ECZA	414	1AJ07MRD173126ZZA	362	1AJ12DKE693046XJA	41
1AJ04ROXXXXX46XJA	147	1AJ06MRD1731F6ZZA	386	1AJ07MRD173226ZZA	362	1AJ12DKE693505XJA	41
1AJ04ROXXXXX98XJA	147	1AJ06MRD1732F6ZZA	386	1AJ07PLXXX1205XJA	239	1AJ12DKE693546XJA	41
1AJ04ROXXXXXK1XJA	147	1AJ06MRD17315EZZA	386	1AJ07PLXXX1246XJA	239	1AJ12DKE700005XJA	42
1AJ04SEJQ65105XJA	31	1AJ06MRD17325EZZA	386	1AJ07PLXXX1298XJA	239	1AJ12DKE700046XJA	42
1AJ04SEJQ65146XJA	31	1AJ06PLXXX1205XJA	238	1AJ07PMD0132F6YZA	362	1AJ12DKE703005XJA	42
1AJ04TKE8200K1XJA	27	1AJ06PLXXX1246XJA	238	1AJ07PMD01325EYZA	362	1AJ12DKE703046XJA	42
1AJ04TKE8230K1XJA	27	1AJ06PLXXX1298XJA	238	1AJ07PMD013226YZA	362	1AJ12DKE703505XJA	42
1AJ04TKE8235K1XJA	27	1AJ06PMD0132F6JZA	386	1AJ07PN025XX02XXI	447	1AJ12DKE703546XJA	42
1AJ04TKE820005XJA	27	1AJ06PMD0132F6LZA	386	1AJ07PN032XX02XXI	447	1AJ12DKT80008BXJA	43
1AJ04TKE820018XJA	27	1AJ06PMD01325EJZA	386	1AJ07RGD1742F6ZZA	362	1AJ12DKT80358BXJA	43
1AJ04TKE820046XJA	27	1AJ06PMD01325ELZA	386	1AJ07RGD17425EZZA	362	1AJ12DKT800005XJA	43
1AJ04TKE823005XJA	27	1AJ06RGD1742F6ZZA	386	1AJ07RGD174226ZZA	362	1AJ12DKT800046XJA	43
1AJ04TKE823018XJA	27	1AJ06RGD17425EZZA	386	1AJ08CDXXXX3DXXX	172	1AJ12DKT80006XJA	43
1AJ04TKE823046XJA	27	1AJ07CDXXXX3DXXX	172	1AJ08CMXXX52F6CZA	410	1AJ12DKT803005XJA	43
1AJ04TKE823505XJA	27	1AJ07CMXXX52F6CZA	411	1AJ08DK01500F6XZA	358	1AJ12DKT803046XJA	43
1AJ04TKE823518XJA	27	1AJ07CMXXX525ECZA	411	1AJ08DK01530F6XZA	358	1AJ12DKT803505XJA	43
1AJ04TKE823546XJA	27	1AJ07CMXXX5226CZA	411	1AJ08DK01535F6XZA	358	1AJ12DKT803546XJA	43
1AJ05CDXXXX3DXXX	172	1AJ07DK01500F6XZA	362	1AJ08DK07530F6XZA	359	1AJ12ID006588BCJA	134
1AJ05PLXXX1205XJA	238	1AJ07DK01530F6XZA	362	1AJ08DK07535F6XZA	359	1AJ12ID0065805CJA	134
1AJ05PLXXX1218XJA	238	1AJ07DK01535F6XZA	362	1AJ08DK07550F6XZA	359	1AJ12ID0065846CJA	134
1AJ05PLXXX1246XJA	238	1AJ07DK07530F6XZA	363	1AJ08DKC8000F6XZA	359	1AJ12IPI06588BCJA	134
1AJ05PLXXX1298XJA	238	1AJ07DK07535F6XZA	363	1AJ08DKC8030F6XZA	359	1AJ12IPI065805CJA	134
1AJ05PN025XX05XXI	446	1AJ07DK07550F6XZA	363	1AJ08DKC8035F6XZA	359	1AJ12IPI065846CJA	134
1AJ05PN025XX31XXI	446	1AJ07DK015005EXZA	362	1AJ08DKT8000F6XZA	359	1AJ12IS006588BCJA	134
1AJ06CDXXXX3DXXX	172	1AJ07DK015305EXZA	362	1AJ08DKT8030F6XZA	359	1AJ12IS0065805CJA	134
1AJ06CMXXX52F6CZA	414	1AJ07DK015355EXZA	362	1AJ08DKT8035F6XZA	359	1AJ12IS0065846CJA	134
1AJ06CMXXX525ECZA	414	1AJ07DK075305EXZA	363	1AJ08ID00663F6CZA	410	1AJ12KPXXX018BXJA	166
1AJ06DK01500F6DZA	387	1AJ07DK075355EXZA	363	1AJ08IPI0663F6CZA	410	1AJ12KPXXX0105XJA	166
1AJ06DK01500F6SZA	387	1AJ07DK075505EXZA	363	1AJ08IS00663F6CZA	410	1AJ12KPXXX138BXJA	166
1AJ06DK01530F6DZA	387	1AJ07DK0150026XZA	362	1AJ08MRD1731F6ZZA	358	1AJ12KPXXX0146XJA	166
1AJ06DK01530F6SZA	387	1AJ07DK0153026XZA	362	1AJ08MRD1732F6ZZA	358	1AJ12KPXXX1305XJA	166
1AJ06DK01535F6DZA	387	1AJ07DK0153526XZA	362	1AJ08MRD731F6ZZA	354	1AJ12KPXXX1346XJA	166
1AJ06DK01535F6SZA	387	1AJ07DK0753026XZA	363	1AJ08MRD732F6ZZA	354	1AJ12KPXXXB68BXJA	166
1AJ06DK015005EDZA	387	1AJ07DK0753526XZA	363	1AJ08PI002XX5PXXI	448	1AJ12KPXXXB605XJA	166
1AJ06DK015005ESZA	387	1AJ07DK0755026XZA	363	1AJ08PI002XX18XXI	448	1AJ12KPXXXB646XJA	166
1AJ06DK015305EDZA	387	1AJ07DKC8000F6XZA	363	1AJ08PMD0132F6YZA	358	1AJ12MPJ12B68BXJA	40
1AJ06DK015305ESZA	387	1AJ07DKC8030F6XZA	363	1AJ08PMD0332F6YZA	354	1AJ12MPJ12B605XJA	40
1AJ06DK015355EDZA	387	1AJ07DKC8035F6XZA	363	1AJ08PN030XX02XXI	447	1AJ12MPJ12B646XJA	40
1AJ06DK015355ESZA	387	1AJ07DKC80005EXZA	363	1AJ08RGD1742F6ZZA	358	1AJ12MPJ12138BXJA	40
1AJ06DKC8000F6DZA	388	1AJ07DKC80305EXZA	363	1AJ08RQD742F6ZZA	354	1AJ12MPJ121305XJA	40
1AJ06DKC8000F6SZA	388	1AJ07DKC80355EXZA	363	1AJ09CDXXXX3DXXX	172	1AJ12MPJ121346XJA	40
1AJ06DKC8030F6DZA	388	1AJ07DKC800026XZA	363	1AJ10CDXXXX3DXXX	172	1AJ12MRJ13318BEJA	40
1AJ06DKC8030F6SZA	388	1AJ07DKC803026XZA	363	1AJ10PI002XX5PXXI	449	1AJ12MRJ13328BEJA	40
1AJ06DKC8035F6DZA	388	1AJ07DKC803526XZA	363	1AJ11CDXXXX3DXXX	172	1AJ12MRJ133105EJA	40
1AJ06DKC8035F6SZA	388	1AJ07DKT8000F6XZA	363	1AJ12CDXXXX3DXXX	172	1AJ12MRJ133146EJA	40
1AJ06DKC80005EDZA	388	1AJ07DKT8030F6XZA	363	1AJ12CMXXX528BCJA	134	1AJ12MRJ133205EJA	40
1AJ06DKC80005ESZA	388	1AJ07DKT8035F6XZA	363	1AJ12CMXXX5205CJA	134	1AJ12MRJ133246EJA	40
1AJ06DKC80305EDZA	388	1AJ07DKT80005EXZA	363	1AJ12CMXXX5246CJA	134	1AJ12PI002XX5PXXI	449

CODE	PAG	CODE	PAG	CODE	PAG	CODE	PAG
1AJ12PJJ12248BVJA	41	1AJ14PJJ142405VJA	129	1AJ16TKE663546XJA	129	1AJ18DKC803046XJA	111
1AJ12PJJ122405VJA	41	1AJ14PJJ142446VJA	129	1AJ16TKT800005XJA	130	1AJ18DKC803052XJA	125
1AJ12PJJ122446VJA	41	1AJ14PMJ14131MJJA	129	1AJ16TKT800046XJA	51	1AJ18DKC803053XJA	125
1AJ12PMJ11138BJJA	41	1AJ14PMJ14131MLJA	129	1AJ16TKT800046XJA	130	1AJ18DKC803056XJA	125
1AJ12PMJ11138BLJA	41	1AJ14PMJ36321MJJA	128	1AJ16TKT803005XJA	130	1AJ18DKC803061XJA	125
1AJ12PMJ39328BJJA	40	1AJ14PMJ36321MLJA	128	1AJ16TKT803046XJA	51	1AJ18DKC803050XJA	111
1AJ12PMJ39328BLJA	40	1AJ14PMJ141305JJA	129	1AJ16TKT803046XJA	130	1AJ18DKC803546XJA	111
1AJ12PMJ111305JJA	41	1AJ14PMJ141305LJA	129	1AJ16TKT803505XJA	130	1AJ18DKC803552XJA	125
1AJ12PMJ111305LJA	41	1AJ14PMJ141346JJA	129	1AJ16TKT803546XJA	51	1AJ18DKC803553XJA	125
1AJ12PMJ111346JJA	41	1AJ14PMJ141346LJA	129	1AJ16TKT803546XJA	130	1AJ18DKC803556XJA	125
1AJ12PMJ111346LJA	41	1AJ14PMJ363205JJA	128	1AJ18BCXXX45K1XJA	149	1AJ18DKC803561XJA	125
1AJ12PMJ393205JJA	40	1AJ14PMJ363205LJA	128	1AJ18BCXXX4505XJA	149	1AJ18DKE6600K1XJA	110
1AJ12PMJ393205LJA	40	1AJ14PMJ363246JJA	128	1AJ18BCXXX4518XJA	149	1AJ18DKE6600P4XJA	124
1AJ12PMJ393246JJA	40	1AJ14PMJ363246LJA	128	1AJ18BCXXX4546XJA	149	1AJ18DKE6600P6XJA	124
1AJ12PMJ393246LJA	40	1AJ14RJJ36421MEJA	128	1AJ18BCXXXX05XJA	149	1AJ18DKE6630K1XJA	110
1AJ12RJJ13428BEJA	40	1AJ14RJJ364205EJA	128	1AJ18BCXXXX18XJA	149	1AJ18DKE6630P4XJA	124
1AJ12RJJ134205EJA	40	1AJ14RJJ364246EJA	128	1AJ18BCXXXX46XJA	149	1AJ18DKE6630P6XJA	124
1AJ12RJJ134246EJA	40	1AJ16CMXXX5246CJA	135	1AJ18BCXXXXK1XJA	149	1AJ18DKE6635K1XJA	110
1AJ13BNXXX458BXJA	148	1AJ16DKC800046DJA	48	1AJ18BNXXX45K1XJA	149	1AJ18DKE6635P4XJA	124
1AJ13BNXXX4505XJA	148	1AJ16DKC800046SJA	48	1AJ18BNXXX4505XJA	149	1AJ18DKE6635P6XJA	124
1AJ13BNXXX4546XJA	148	1AJ16DKC803046DJA	48	1AJ18BNXXX4518XJA	149	1AJ18DKE6900K1XJA	110
1AJ13BNXXX05XJA	148	1AJ16DKC803046SJA	48	1AJ18BNXXX4546XJA	149	1AJ18DKE6900P4XJA	124
1AJ13BNXXX8BXJA	148	1AJ16DKC803546DJA	48	1AJ18BNXXX05XJA	149	1AJ18DKE6900P6XJA	124
1AJ13BNXXX46XJA	148	1AJ16DKC803546SJA	48	1AJ18BNXXX18XJA	149	1AJ18DKE6930K1XJA	110
1AJ13BYXXX458BXJA	148	1AJ16DKE660046DJA	47	1AJ18BNXXX46XJA	149	1AJ18DKE6930P4XJA	124
1AJ13BYXXX4505XJA	148	1AJ16DKE660046SJA	47	1AJ18BNXXXK1XJA	149	1AJ18DKE6930P6XJA	124
1AJ13BYXXX4546XJA	148	1AJ16DKE663046DJA	47	1AJ18BYXXX45K1XJA	150	1AJ18DKE6935K1XJA	110
1AJ13BYXXX05XJA	148	1AJ16DKE663046SJA	47	1AJ18BYXXX4505XJA	150	1AJ18DKE6935P4XJA	124
1AJ13BYXXX8BXJA	148	1AJ16DKE663546DJA	47	1AJ18BYXXX4518XJA	150	1AJ18DKE6935P6XJA	124
1AJ13BYXXX46XJA	148	1AJ16DKE663546SJA	47	1AJ18BYXXX4546XJA	150	1AJ18DKE7000K1XJA	111
1AJ13ROXXX458BXJA	148	1AJ16DKT800046DJA	49	1AJ18BYXXX05XJA	149	1AJ18DKE7000P4XJA	124
1AJ13ROXXX4505XJA	148	1AJ16DKT800046SJA	49	1AJ18BYXXX18XJA	149	1AJ18DKE7000P6XJA	124
1AJ13ROXXX4546XJA	148	1AJ16DKT803046DJA	49	1AJ18BYXXX46XJA	149	1AJ18DKE7030K1XJA	111
1AJ13ROXXX05XJA	148	1AJ16DKT803046SJA	49	1AJ18BYXXXK1XJA	149	1AJ18DKE7030P4XJA	124
1AJ13ROXXX8BXJA	148	1AJ16DKT803546DJA	49	1AJ18CMXXX52K1CJA	140	1AJ18DKE7030P6XJA	124
1AJ13ROXXX46XJA	148	1AJ16DKT803546SJA	49	1AJ18CMXXX52P4CJA	141	1AJ18DKE7035K1XJA	111
1AJ14CMXXX521MCJA	141	1AJ16ID0065846CJA	135	1AJ18CMXXX52P6CJA	141	1AJ18DKE7035P4XJA	124
1AJ14CMXXX5205CJA	141	1AJ16IDIO65846CJA	135	1AJ18CMXXX5250CJA	140	1AJ18DKE7035P6XJA	124
1AJ14CMXXX5246CJA	141	1AJ16IS0065846CJA	135	1AJ18CMXXX525SCJA	140	1AJ18DKE660050XJA	117
1AJ14ID006581MCJA	141	1AJ16ISIO65846CJA	135	1AJ18CMXXX5205CJA	140	1AJ18DKE66005SXJA	117
1AJ14ID0065805CJA	141	1AJ16KPXXX0146XJA	167	1AJ18CMXXX5246CJA	140	1AJ18DKE663050XJA	117
1AJ14ID0065846CJA	141	1AJ16KPXXX1346XJA	167	1AJ18CMXXX5252CJA	141	1AJ18DKE66305SXJA	117
1AJ14IS006581MCJA	141	1AJ16KPXXXB646XJA	167	1AJ18CMXXX5253CJA	141	1AJ18DKE663550XJA	117
1AJ14IS0065805CJA	141	1AJ16MAJ165105XJA	131	1AJ18CMXXX5256CJA	141	1AJ18DKE66355SXJA	117
1AJ14IS0065846CJA	141	1AJ16MAJ165146XJA	51	1AJ18CMXXX5261CJA	141	1AJ18DKE690050XJA	117
1AJ14KPXXX011MXJA	167	1AJ16MAJ165146XJA	131	1AJ18DKC8000K1XJA	111	1AJ18DKE69005SXJA	117
1AJ14KPXXX0105XJA	167	1AJ16MPJ16B646XJA	46	1AJ18DKC8000P4XJA	125	1AJ18DKE693050XJA	117
1AJ14KPXXX131MXJA	167	1AJ16MPJ161346XJA	46	1AJ18DKC8000P6XJA	125	1AJ18DKE69305SXJA	117
1AJ14KPXXX0146XJA	167	1AJ16PMJ161346JJA	46	1AJ18DKC8030K1XJA	111	1AJ18DKE693550XJA	117
1AJ14KPXXX1305XJA	167	1AJ16PMJ161346LJA	46	1AJ18DKC8030P4XJA	125	1AJ18DKE69355SXJA	117
1AJ14KPXXX1346XJA	167	1AJ16TKC800005XJA	130	1AJ18DKC8030P6XJA	125	1AJ18DKE700050XJA	118
1AJ14KPXXXB61MXJA	167	1AJ16TKC800046XJA	50	1AJ18DKC8035K1XJA	111	1AJ18DKE70005SXJA	118
1AJ14KPXXXB605XJA	167	1AJ16TKC800046XJA	130	1AJ18DKC8035P4XJA	125	1AJ18DKE703050XJA	118
1AJ14KPXXXB646XJA	167	1AJ16TKC803005XJA	130	1AJ18DKC8035P6XJA	125	1AJ18DKE70305SXJA	118
1AJ14MPJ14B61MXJA	128	1AJ16TKC803046XJA	50	1AJ18DKC800050XJA	118	1AJ18DKE703550XJA	118
1AJ14MPJ14B605XJA	128	1AJ16TKC803046XJA	130	1AJ18DKC80005SXJA	118	1AJ18DKE70355SXJA	118
1AJ14MPJ14B646XJA	128	1AJ16TKC803505XJA	130	1AJ18DKC803050XJA	118	1AJ18DKE660005XJA	110
1AJ14MPJ14131MXJA	128	1AJ16TKC803546XJA	50	1AJ18DKC80305SXJA	118	1AJ18DKE660046XJA	110
1AJ14MPJ141305XJA	128	1AJ16TKC803546XJA	130	1AJ18DKC803550XJA	118	1AJ18DKE660052XJA	124
1AJ14MPJ141346XJA	128	1AJ16TKE660005XJA	129	1AJ18DKC80355SXJA	118	1AJ18DKE660053XJA	124
1AJ14MRJ36311MEJA	128	1AJ16TKE660046XJA	50	1AJ18DKC800005XJA	111	1AJ18DKE660056XJA	124
1AJ14MRJ36321MEJA	128	1AJ16TKE660046XJA	129	1AJ18DKC800046XJA	111	1AJ18DKE660061XJA	124
1AJ14MRJ363105EJA	128	1AJ16TKE663005XJA	129	1AJ18DKC800052XJA	125	1AJ18DKE663005XJA	110
1AJ14MRJ363146EJA	128	1AJ16TKE663046XJA	50	1AJ18DKC800053XJA	125	1AJ18DKE663046XJA	110
1AJ14MRJ363205EJA	128	1AJ16TKE663046XJA	129	1AJ18DKC800056XJA	125	1AJ18DKE663052XJA	124
1AJ14MRJ363246EJA	128	1AJ16TKE663505XJA	129	1AJ18DKC800061XJA	125	1AJ18DKE663053XJA	124
1AJ14PJJ14241MVJA	129	1AJ16TKE663546XJA	50	1AJ18DKC803005XJA	111	1AJ18DKE663056XJA	124

CODE	PAG	CODE	PAG	CODE	PAG	CODE	PAG
1AJ18DKE663061XJA	124	1AJ18DKT803053XJA	125	1AJ18MPJ18B653XJA	123	1AJ18PMJ131305JJA	109
1AJ18DKE663505XJA	110	1AJ18DKT803056XJA	125	1AJ18MPJ18B656XJA	123	1AJ18PMJ131305LJA	109
1AJ18DKE663546XJA	110	1AJ18DKT803061XJA	125	1AJ18MPJ18B661XJA	123	1AJ18PMJ131346JJA	109
1AJ18DKE663552XJA	124	1AJ18DKT803505XJA	112	1AJ18MPJ1813P4XJA	123	1AJ18PMJ131346LJA	109
1AJ18DKE663553XJA	124	1AJ18DKT803546XJA	112	1AJ18MPJ1813P6XJA	123	1AJ18PMJ131352JJA	123
1AJ18DKE663556XJA	124	1AJ18DKT803552XJA	125	1AJ18MPJ031305XJA	108	1AJ18PMJ131352LJA	123
1AJ18DKE663561XJA	124	1AJ18DKT803553XJA	125	1AJ18MPJ031346XJA	108	1AJ18PMJ131353JJA	123
1AJ18DKE690005XJA	110	1AJ18DKT803556XJA	125	1AJ18MPJ031352XJA	122	1AJ18PMJ131353LJA	123
1AJ18DKE690046XJA	110	1AJ18DKT803561XJA	125	1AJ18MPJ031353XJA	122	1AJ18PMJ131356JJA	123
1AJ18DKE690052XJA	124	1AJ18HD3136905XJA	265	1AJ18MPJ031356XJA	122	1AJ18PMJ131356LJA	123
1AJ18DKE690053XJA	124	1AJ18HD3136946XJA	265	1AJ18MPJ031361XJA	122	1AJ18PMJ131361JJA	123
1AJ18DKE690056XJA	124	1AJ18HS3130005XJA	265	1AJ18MPJ181305XJA	109	1AJ18PMJ131361LJA	123
1AJ18DKE690061XJA	124	1AJ18HS3130046XJA	265	1AJ18MPJ181346XJA	109	1AJ18PMJ181305JJA	109
1AJ18DKE693005XJA	110	1AJ18HS3136905XJA	265	1AJ18MPJ181352XJA	123	1AJ18PMJ181305LJA	109
1AJ18DKE693046XJA	110	1AJ18HS3136946XJA	265	1AJ18MPJ181353XJA	123	1AJ18PMJ181346JJA	109
1AJ18DKE693052XJA	124	1AJ18ID00658K1CJA	140	1AJ18MPJ181356XJA	123	1AJ18PMJ181346LJA	109
1AJ18DKE693053XJA	124	1AJ18ID00658P4CJA	141	1AJ18MPJ181361XJA	123	1AJ18PMJ181352JJA	123
1AJ18DKE693056XJA	124	1AJ18ID00658P6CJA	141	1AJ18MRJ1831K1EJA	108	1AJ18PMJ181352LJA	123
1AJ18DKE693061XJA	124	1AJ18ID0065805CJA	140	1AJ18MRJ1831P4EJA	122	1AJ18PMJ181353JJA	123
1AJ18DKE693505XJA	110	1AJ18ID0065846CJA	140	1AJ18MRJ1831P6EJA	122	1AJ18PMJ181353LJA	123
1AJ18DKE693546XJA	110	1AJ18ID0065852CJA	141	1AJ18MRJ1832K1EJA	108	1AJ18PMJ181356JJA	123
1AJ18DKE693552XJA	124	1AJ18ID0065853CJA	141	1AJ18MRJ1832P4EJA	122	1AJ18PMJ181356LJA	123
1AJ18DKE693553XJA	124	1AJ18ID0065856CJA	141	1AJ18MRJ1832P6EJA	122	1AJ18PMJ181361JJA	123
1AJ18DKE693556XJA	124	1AJ18ID0065861CJA	141	1AJ18MRJ033150EJA	116	1AJ18PMJ181361LJA	123
1AJ18DKE693561XJA	124	1AJ18IPI0658K1CJA	140	1AJ18MRJ033155EJA	116	1AJ18PMJ193205JJA	108
1AJ18DKE700005XJA	111	1AJ18IPI0658P4CJA	141	1AJ18MRJ033250EJA	116	1AJ18PMJ193205LJA	108
1AJ18DKE700046XJA	111	1AJ18IPI0658P6CJA	141	1AJ18MRJ033255EJA	116	1AJ18PMJ193246JJA	108
1AJ18DKE700052XJA	124	1AJ18IPI065850CJA	140	1AJ18MRJ183105EJA	108	1AJ18PMJ193246LJA	108
1AJ18DKE700053XJA	124	1AJ18IPI065855CJA	140	1AJ18MRJ183146EJA	108	1AJ18PMJ193252JJA	122
1AJ18DKE700056XJA	124	1AJ18IPI065805CJA	140	1AJ18MRJ183152EJA	122	1AJ18PMJ193252LJA	122
1AJ18DKE700061XJA	124	1AJ18IPI065846CJA	140	1AJ18MRJ183153EJA	122	1AJ18PMJ193253JJA	122
1AJ18DKE703005XJA	111	1AJ18IPI065852CJA	141	1AJ18MRJ183156EJA	122	1AJ18PMJ193253LJA	122
1AJ18DKE703046XJA	111	1AJ18IPI065853CJA	141	1AJ18MRJ183161EJA	122	1AJ18PMJ193256JJA	122
1AJ18DKE703052XJA	124	1AJ18IPI065856CJA	141	1AJ18MRJ183205EJA	108	1AJ18PMJ193256LJA	122
1AJ18DKE703053XJA	124	1AJ18IPI065861CJA	141	1AJ18MRJ183246EJA	108	1AJ18PMJ193261JJA	122
1AJ18DKE703056XJA	124	1AJ18IS00658K1CJA	140	1AJ18MRJ183252EJA	122	1AJ18PMJ193261LJA	122
1AJ18DKE703061XJA	124	1AJ18IS00658P4CJA	141	1AJ18MRJ183253EJA	122	1AJ18RJJ1842K1EJA	108
1AJ18DKE703505XJA	111	1AJ18IS00658P6CJA	141	1AJ18MRJ183256EJA	122	1AJ18RJJ1842P4EJA	122
1AJ18DKE703546XJA	111	1AJ18IS0065805CJA	140	1AJ18MRJ183261EJA	122	1AJ18RJJ1842P6EJA	122
1AJ18DKE703552XJA	124	1AJ18IS0065846CJA	140	1AJ18PJJ1824P4VJA	123	1AJ18RJJ034250EJA	116
1AJ18DKE703553XJA	124	1AJ18IS0065852CJA	141	1AJ18PJJ1824P6VJA	123	1AJ18RJJ034255EJA	116
1AJ18DKE703556XJA	124	1AJ18IS0065853CJA	141	1AJ18PJJ032405VJA	109	1AJ18RJJ184205EJA	108
1AJ18DKE703561XJA	124	1AJ18IS0065856CJA	141	1AJ18PJJ032446VJA	109	1AJ18RJJ184246EJA	108
1AJ18DKT8000K1XJA	112	1AJ18IS0065861CJA	141	1AJ18PJJ032452VJA	123	1AJ18RJJ184252EJA	122
1AJ18DKT8000P4XJA	125	1AJ18KPXXX0102XJA	168	1AJ18PJJ032453VJA	123	1AJ18RJJ184253EJA	122
1AJ18DKT8000P6XJA	125	1AJ18KPXXX0105XJA	168	1AJ18PJJ032456VJA	123	1AJ18RJJ184256EJA	122
1AJ18DKT8030K1XJA	112	1AJ18KPXXX0146XJA	168	1AJ18PJJ032461VJA	123	1AJ18RJJ184261EJA	122
1AJ18DKT8030P4XJA	125	1AJ18KPXXX1302XJA	168	1AJ18PJJ182405VJA	109	1AJ18ROOFP45K1XJA	150
1AJ18DKT8030P6XJA	125	1AJ18KPXXX1305XJA	168	1AJ18PJJ182446VJA	109	1AJ18ROOFP4505XJA	150
1AJ18DKT8035K1XJA	112	1AJ18KPXXX1346XJA	168	1AJ18PJJ182452VJA	123	1AJ18ROOFP4518XJA	150
1AJ18DKT8035P4XJA	125	1AJ18KPXXXB602XJA	168	1AJ18PJJ182453VJA	123	1AJ18ROOFP4546XJA	150
1AJ18DKT8035P6XJA	125	1AJ18KPXXXB605XJA	168	1AJ18PJJ182456VJA	123	1AJ18ROXXX45K1XJA	150
1AJ18DKT800050XJA	119	1AJ18KPXXXB646XJA	168	1AJ18PJJ182461VJA	123	1AJ18ROXXX4505XJA	150
1AJ18DKT80005SXJA	119	1AJ18MAJ1651K1XJA	112	1AJ18PMJ1813P4JJA	123	1AJ18ROXXX4518XJA	150
1AJ18DKT803050XJA	119	1AJ18MAJ165105XJA	112	1AJ18PMJ1813P4LJA	123	1AJ18ROXXX4546XJA	150
1AJ18DKT80305SXJA	119	1AJ18MAJ165146XJA	112	1AJ18PMJ1813P6JJA	123	1AJ18ROXXX05XJA	150
1AJ18DKT803550XJA	119	1AJ18MPJ03B605XJA	108	1AJ18PMJ1813P6LJA	123	1AJ18ROXXXX18XJA	150
1AJ18DKT80355SXJA	119	1AJ18MPJ03B646XJA	108	1AJ18PMJ1932K1JJA	108	1AJ18ROXXXX46XJA	150
1AJ18DKT800005XJA	112	1AJ18MPJ03B652XJA	122	1AJ18PMJ1932K1LJA	108	1AJ18ROXXXXK1XJA	150
1AJ18DKT800046XJA	112	1AJ18MPJ03B653XJA	122	1AJ18PMJ1932P4JJA	122	1AJ18SEJ1651K1XJA	112
1AJ18DKT800052XJA	125	1AJ18MPJ03B656XJA	122	1AJ18PMJ1932P4LJA	122	1AJ18SEJ165105XJA	112
1AJ18DKT800053XJA	125	1AJ18MPJ03B661XJA	122	1AJ18PMJ1932P6JJA	122	1AJ18SEJ165146XJA	112
1AJ18DKT800056XJA	125	1AJ18MPJ18B6P4XJA	123	1AJ18PMJ1932P6LJA	122	1AJ18TKE6900K1XJA	113
1AJ18DKT800061XJA	125	1AJ18MPJ18B6P6XJA	123	1AJ18PMJ403250JJA	116	1AJ18TKE6930K1XJA	113
1AJ18DKT803005XJA	112	1AJ18MPJ18B605XJA	109	1AJ18PMJ403250LJA	116	1AJ18TKE690005XJA	113
1AJ18DKT803046XJA	112	1AJ18MPJ18B646XJA	109	1AJ18PMJ403255JJA	116	1AJ18TKE690046XJA	113
1AJ18DKT803052XJA	125	1AJ18MPJ18B652XJA	123	1AJ18PMJ403255LJA	116		

CODE	PAG	CODE	PAG	CODE	PAG	CODE	PAG
1AJ18TKE693005XJA	113	1AJ26DKT803005XJA	105	1AJ27CDXXXXX3DXXX	419	1AJ30BCXXX4546XJA	151
1AJ18TKE693046XJA	113	1AJ26DKT803018XJA	105	1AJ27CMXXX5205CJA	137	1AJ30BCXXXXX5SXJA	151
1AJ18TKE693505XJA	113	1AJ26DKT803505XJA	105	1AJ27CMXXX5218CJA	137	1AJ30BCXXXXX05XJA	151
1AJ18TKE693546XJA	113	1AJ26DKT803518XJA	105	1AJ27DKC810005XJA	74	1AJ30BCXXXXX18XJA	151
1AJ20JRJ374218EJA	60	1AJ26DKT810005XJA	101	1AJ27DKC810018XJA	74	1AJ30BCXXXXX46XJA	151
1AJ20JRJ374298EJA	60	1AJ26DKT810018XJA	101	1AJ27DKC813005XJA	74	1AJ30BCXXXXXK1XJA	151
1AJ20MRJ373118EJA	60	1AJ26DKT813005XJA	101	1AJ27DKC813018XJA	74	1AJ30BNXXX45K1XJA	151
1AJ20MRJ373198EJA	60	1AJ26DKT813018XJA	101	1AJ27DKC813505XJA	74	1AJ30BNXXX455SXJA	151
1AJ20MRJ373218EJA	60	1AJ26DKT813505XJA	101	1AJ27DKC813518XJA	74	1AJ30BNXXX4505XJA	151
1AJ20MRJ373298EJA	60	1AJ26DKT813518XJA	101	1AJ27DKE690005XJA	73	1AJ30BNXXX4518XJA	151
1AJ20PMJ383218JJA	60	1AJ26HDQ136905XJA	263	1AJ27DKE690018XJA	73	1AJ30BNXXX4546XJA	151
1AJ20PMJ383218LJA	60	1AJ26HSQ130005XJA	263	1AJ27DKE693005XJA	73	1AJ30BNXXXXX5SXJA	151
1AJ20PMJ383298JJA	60	1AJ26HSQ136905XJA	263	1AJ27DKE693018XJA	73	1AJ30BNXXXXX05XJA	151
1AJ20PMJ383298LJA	60	1AJ26ID006585SCJA	139	1AJ27DKE693505XJA	73	1AJ30BNXXXXX18XJA	151
1AJ21CDXXXXX3DXXX	419	1AJ26ID0065805CJA	139	1AJ27DKE693518XJA	73	1AJ30BNXXXXX46XJA	151
1AJ22CDXXXXX3DXXX	419	1AJ26ID0065818CJA	139	1AJ27DKE700005XJA	73	1AJ30BNXXXXXK1XJA	151
1AJ23CDXXXXX3DXXX	419	1AJ26IPI06585SCJA	139	1AJ27DKE700018XJA	73	1AJ30BYXXX45K1XJA	152
1AJ24CDXXXXX3DXXX	419	1AJ26IPI065805CJA	139	1AJ27DKE703005XJA	73	1AJ30BYXXX455SXJA	152
1AJ25CDXXXXX3DXXX	419	1AJ26IPI065818CJA	139	1AJ27DKE703018XJA	73	1AJ30BYXXX4505XJA	152
1AJ26CDXXXXX3DXXX	419	1AJ26IS006585SCJA	139	1AJ27DKE703505XJA	73	1AJ30BYXXX4518XJA	152
1AJ26CMXXX525SCJA	139	1AJ26IS0065805CJA	139	1AJ27DKE703518XJA	73	1AJ30BYXXX4546XJA	152
1AJ26CMXXX5205CJA	139	1AJ26IS0065818CJA	139	1AJ27DKE820005XJA	74	1AJ30BYXXXGF5SXJA	242
1AJ26CMXXX5218CJA	139	1AJ26JRJ01425SEJA	104	1AJ27DKE820018XJA	74	1AJ30BYXXXGF05XJA	242
1AJ26DKC80005SXJA	105	1AJ26JRJ014205EJA	104	1AJ27DKE823005XJA	74	1AJ30BYXXXGF98XJA	242
1AJ26DKC80305SXJA	105	1AJ26JRJ014218EJA	104	1AJ27DKE823018XJA	74	1AJ30BYXXXXX5SXJA	151
1AJ26DKC80355SXJA	105	1AJ26JRJ30425SEJA	98	1AJ27DKE823505XJA	74	1AJ30BYXXXXX05XJA	151
1AJ26DKC81005SXJA	100	1AJ26JRJ37425SEJA	99	1AJ27DKE823518XJA	74	1AJ30BYXXXXX18XJA	151
1AJ26DKC81305SXJA	100	1AJ26JRJ304205EJA	98	1AJ27DKT810005XJA	74	1AJ30BYXXXXX46XJA	151
1AJ26DKC81355SXJA	100	1AJ26JRJ304218EJA	98	1AJ27DKT810018XJA	74	1AJ30BYXXXXXK1XJA	151
1AJ26DKC800005XJA	105	1AJ26JRJ374205EJA	99	1AJ27DKT813005XJA	74	1AJ30CDXXXXX3DXXX	419
1AJ26DKC800018XJA	105	1AJ26JRJ374218EJA	99	1AJ27DKT813018XJA	74	1AJ30RO0FP45K1XJA	152
1AJ26DKC803005XJA	105	1AJ26MRJ01315SEJA	104	1AJ27DKT813505XJA	74	1AJ30RO0FP455SXJA	152
1AJ26DKC803018XJA	105	1AJ26MRJ01325SEJA	104	1AJ27DKT813518XJA	74	1AJ30RO0FP4505XJA	152
1AJ26DKC803505XJA	105	1AJ26MRJ013105EJA	104	1AJ27ID0065805CJA	137	1AJ30RO0FP4518XJA	152
1AJ26DKC803518XJA	105	1AJ26MRJ013118EJA	104	1AJ27ID0065818CJA	137	1AJ30RO0FP4546XJA	152
1AJ26DKC810005XJA	100	1AJ26MRJ013205EJA	104	1AJ27IPI065805CJA	137	1AJ30ROXXX45K1XJA	152
1AJ26DKC810018XJA	100	1AJ26MRJ013218EJA	104	1AJ27IPI065818CJA	137	1AJ30ROXXX455SXJA	152
1AJ26DKC813005XJA	100	1AJ26MRJ30315SEJA	98	1AJ27IS0065805CJA	137	1AJ30ROXXX4505XJA	152
1AJ26DKC813018XJA	100	1AJ26MRJ30325SEJA	98	1AJ27IS0065818CJA	137	1AJ30ROXXX4518XJA	152
1AJ26DKC813505XJA	100	1AJ26MRJ37315SEJA	99	1AJ27JPJ042405VJA	73	1AJ30ROXXX4546XJA	152
1AJ26DKC813518XJA	100	1AJ26MRJ37325SEJA	99	1AJ27JPJ042418VJA	73	1AJ30ROXXXGF5SXJA	240
1AJ26DKE66005SXJA	104	1AJ26MRJ303105EJA	98	1AJ27JRJ304205EJA	72	1AJ30ROXXXGF05XJA	240
1AJ26DKE66305SXJA	104	1AJ26MRJ303118EJA	98	1AJ27JRJ304218EJA	72	1AJ30ROXXXGF98XJA	240
1AJ26DKE66355SXJA	104	1AJ26MRJ303205EJA	98	1AJ27MPJ04B605XJA	72	1AJ30ROXXXXX5SXJA	152
1AJ26DKE82005SXJA	100	1AJ26MRJ303218EJA	98	1AJ27MPJ04B618XJA	72	1AJ30ROXXXXX05XJA	152
1AJ26DKE82305SXJA	100	1AJ26MRJ373105EJA	99	1AJ27MPJ041305XJA	72	1AJ30ROXXXXX18XJA	152
1AJ26DKE82355SXJA	100	1AJ26MRJ373118EJA	99	1AJ27MPJ041318XJA	72	1AJ30ROXXXXX46XJA	152
1AJ26DKE660005XJA	104	1AJ26MRJ373205EJA	99	1AJ27MRJ303105EJA	72	1AJ30ROXXXXXK1XJA	152
1AJ26DKE660018XJA	104	1AJ26MRJ373218EJA	99	1AJ27MRJ303118EJA	72	1AJ31CDXXXXX3DXXX	419
1AJ26DKE663005XJA	104	1AJ26PMJ20325SJJJA	104	1AJ27MRJ303205EJA	72	1AJ32CDXXXXX3DXXX	419
1AJ26DKE663018XJA	104	1AJ26PMJ20325SLJA	104	1AJ27MRJ303218EJA	72	1AJ35CMXXX52L6CJA	138
1AJ26DKE663505XJA	104	1AJ26PMJ30325SJJJA	98	1AJ27PMJ303205JJA	72	1AJ35CMXXX526PCJA	138
1AJ26DKE663518XJA	104	1AJ26PMJ30325SLJA	98	1AJ27PMJ303205LJA	72	1AJ35DKE6900L6XJA	85
1AJ26DKE663518XJA	104	1AJ26PMJ30325SLJA	98	1AJ27PMJ303218JJA	72	1AJ35DKE6930L6XJA	85
1AJ26DKE820005XJA	100	1AJ26PMJ38325SJJJA	99	1AJ27PMJ303218LJA	72	1AJ35DKE6935L6XJA	85
1AJ26DKE820018XJA	100	1AJ26PMJ38325SLJA	99	1AJ27PMJ331305JJA	73	1AJ35DKE7000L6XJA	85
1AJ26DKE823005XJA	100	1AJ26PMJ203205JJA	104	1AJ27PMJ331305LJA	73	1AJ35DKE7030L6XJA	85
1AJ26DKE823018XJA	100	1AJ26PMJ203205LJA	104	1AJ27PMJ331318JJA	73	1AJ35DKE7035L6XJA	85
1AJ26DKE823505XJA	100	1AJ26PMJ203218JJA	104	1AJ27PMJ331318LJA	73	1AJ35DKE69006PXJA	85
1AJ26DKE823518XJA	100	1AJ26PMJ203218LJA	104	1AJ27SEJQ65105XJA	75	1AJ35DKE69306PXJA	85
1AJ26DKT80005SXJA	105	1AJ26PMJ303205JJA	98	1AJ27SEJQ65118XJA	75	1AJ35DKE69356PXJA	85
1AJ26DKT80305SXJA	105	1AJ26PMJ303205LJA	98	1AJ28CDXXXXX3DXXX	419	1AJ35DKE70006PXJA	85
1AJ26DKT80355SXJA	105	1AJ26PMJ303218JJA	98	1AJ29CDXXXXX3DXXX	419	1AJ35DKE70306PXJA	85
1AJ26DKT81005SXJA	101	1AJ26PMJ303218LJA	98	1AJ30BCXXX45K1XJA	151	1AJ35DKE70356PXJA	85
1AJ26DKT81305SXJA	101	1AJ26PMJ383205JJA	99	1AJ30BCXXX455SXJA	151	1AJ35ID00658L6CJA	138
1AJ26DKT81305SXJA	101	1AJ26PMJ383205LJA	99	1AJ30BCXXX4505XJA	151	1AJ35ID006586PCJA	138
1AJ26DKT800005XJA	105	1AJ26PMJ383218JJA	99	1AJ30BCXXX4518XJA	151	1AJ35IPI0658L6CJA	138
1AJ26DKT800018XJA	105	1AJ26PMJ383218LJA	99				

CODE	PAG	CODE	PAG	CODE	PAG	CODE	PAG
1AJ35IPI06586PCJA	138	1AJ36DKC800005XJA	80	1AJ36IS0065846CJA	137	1AJ37DKC803518XJA	69
1AJ35IS00658L6CJA	138	1AJ36DKC800046XJA	80	1AJ36IS0065898CJA	137	1AJ37DKE66005SXJA	68
1AJ35IS006586PCJA	138	1AJ36DKC800098XJA	80	1AJ36MRJ36318BEJA	78	1AJ37DKE66305SXJA	68
1AJ35JPJ3524L6VJA	85	1AJ36DKC803005XJA	80	1AJ36MRJ36328BEJA	78	1AJ37DKE66355SXJA	68
1AJ35JPJ35246PVJA	85	1AJ36DKC803046XJA	80	1AJ36MRJ363105EJA	78	1AJ37DKE690005SXJA	65
1AJ35JRJ0342L6EJA	84	1AJ36DKC803098XJA	80	1AJ36MRJ363146EJA	78	1AJ37DKE69305SXJA	65
1AJ35JRJ03426PEJA	84	1AJ36DKC803505XJA	80	1AJ36MRJ363198EJA	78	1AJ37DKE69355SXJA	65
1AJ35KPXXX0105XJA	169	1AJ36DKC803546XJA	80	1AJ36MRJ363205EJA	78	1AJ37DKE70005SXJA	65
1AJ35KPXXX0198XJA	169	1AJ36DKC803598XJA	80	1AJ36MRJ363246EJA	78	1AJ37DKE70305SXJA	65
1AJ35KPXXX1305XJA	169	1AJ36DKE66008BXJA	79	1AJ36MRJ363298EJA	78	1AJ37DKE70355SXJA	65
1AJ35KPXXX1398XJA	169	1AJ36DKE66308BXJA	79	1AJ36PMJ36328BJJA	78	1AJ37DKE660005XJA	68
1AJ35KPXXXB605XJA	169	1AJ36DKE66358BXJA	79	1AJ36PMJ36328LJJA	78	1AJ37DKE660018XJA	68
1AJ35KPXXXB698XJA	169	1AJ36DKE69008BXJA	79	1AJ36PMJ363205JJA	78	1AJ37DKE663005XJA	68
1AJ35MPJ35B6L6XJA	84	1AJ36DKE69308BXJA	79	1AJ36PMJ363205LJA	78	1AJ37DKE663018XJA	68
1AJ35MPJ35B66PXJA	84	1AJ36DKE69358BXJA	79	1AJ36PMJ363246JJA	78	1AJ37DKE663505XJA	68
1AJ35MPJ3513L6XJA	84	1AJ36DKE70008BXJA	80	1AJ36PMJ363246LJA	78	1AJ37DKE663518XJA	68
1AJ35MPJ35136PXJA	84	1AJ36DKE70308BXJA	80	1AJ36PMJ363298JJA	78	1AJ37DKE690005XJA	65
1AJ35MRJ0331L6EJA	84	1AJ36DKE70358BXJA	80	1AJ36PMJ363298LJA	78	1AJ37DKE690018XJA	65
1AJ35MRJ0332L6EJA	84	1AJ36DKE660005XJA	79	1AJ36RJJ36428BEJA	78	1AJ37DKE693005XJA	65
1AJ35MRJ03316PEJA	84	1AJ36DKE660046XJA	79	1AJ36RJJ364205EJA	78	1AJ37DKE693018XJA	65
1AJ35MRJ03326PEJA	84	1AJ36DKE660098XJA	79	1AJ36RJJ364246EJA	78	1AJ37DKE693505XJA	65
1AJ35PMJ0332L6JJA	84	1AJ36DKE663005XJA	79	1AJ36RJJ364298EJA	78	1AJ37DKE693518XJA	65
1AJ35PMJ0332L6LJA	84	1AJ36DKE663046XJA	79	1AJ36ROOFP451MXJA	154	1AJ37DKE700005XJA	65
1AJ35PMJ03326PJJA	84	1AJ36DKE663098XJA	79	1AJ36ROOFP458BXJA	154	1AJ37DKE700018XJA	65
1AJ35PMJ03326PLJA	84	1AJ36DKE663505XJA	79	1AJ36ROOFP4505XJA	154	1AJ37DKE703005XJA	65
1AJ35PMJ3513L6JJA	85	1AJ36DKE663546XJA	79	1AJ36ROOFP4546XJA	154	1AJ37DKE703018XJA	65
1AJ35PMJ3513L6LJA	85	1AJ36DKE663598XJA	79	1AJ36ROOFP4598XJA	154	1AJ37DKE703505XJA	65
1AJ35PMJ35136PJJA	85	1AJ36DKE690005XJA	79	1AJ36ROXXX451MXJA	154	1AJ37DKE703518XJA	65
1AJ35PMJ35136PLJA	85	1AJ36DKE690046XJA	79	1AJ36ROXXX458BXJA	154	1AJ37DKT800005SXJA	69
1AJ36BCXXX451MXJA	153	1AJ36DKE690098XJA	79	1AJ36ROXXX4505XJA	154	1AJ37DKT80305SXJA	69
1AJ36BCXXX458BXJA	153	1AJ36DKE693005XJA	79	1AJ36ROXXX4546XJA	154	1AJ37DKT80355SXJA	69
1AJ36BCXXX4505XJA	153	1AJ36DKE693046XJA	79	1AJ36ROXXX4598XJA	154	1AJ37DKT800005XJA	69
1AJ36BCXXX4546XJA	153	1AJ36DKE693098XJA	79	1AJ36ROXXXG98XJA	241	1AJ37DKT800018XJA	69
1AJ36BCXXX4598XJA	153	1AJ36DKE693505XJA	79	1AJ36ROXXXX1MXJA	154	1AJ37DKT803005XJA	69
1AJ36BCXXXXX1MXJA	153	1AJ36DKE693546XJA	79	1AJ36ROXXXX05XJA	154	1AJ37DKT803018XJA	69
1AJ36BCXXXXX05XJA	153	1AJ36DKE693598XJA	79	1AJ36ROXXXX8BXJA	154	1AJ37DKT803505XJA	69
1AJ36BCXXXXX8BXJA	153	1AJ36DKE700005XJA	80	1AJ36ROXXXX46XJA	154	1AJ37DKT803518XJA	69
1AJ36BCXXXXX46XJA	153	1AJ36DKE700046XJA	80	1AJ36ROXXXX98XJA	154	1AJ37ID0065805CJA	136
1AJ36BCXXXXX98XJA	153	1AJ36DKE700098XJA	80	1AJ37BCXXX455SXJA	155	1AJ37ID0065818CJA	136
1AJ36BNXXX451MXJA	153	1AJ36DKE703005XJA	80	1AJ37BCXXX4505XJA	155	1AJ37IPI06585SCJA	136
1AJ36BNXXX458BXJA	153	1AJ36DKE703046XJA	80	1AJ37BCXXX4518XJA	155	1AJ37IPI065805CJA	136
1AJ36BNXXX4505XJA	153	1AJ36DKE703098XJA	80	1AJ37BCXXX5SXJA	155	1AJ37IPI065818CJA	136
1AJ36BNXXX4546XJA	153	1AJ36DKE703505XJA	80	1AJ37BCXXXX05XJA	155	1AJ37IS0065805CJA	136
1AJ36BNXXX4598XJA	153	1AJ36DKE703546XJA	80	1AJ37BCXXXX18XJA	155	1AJ37IS0065818CJA	136
1AJ36BNXXXXX1MXJA	153	1AJ36DKE703598XJA	80	1AJ37BNXXX455SXJA	155	1AJ37JRJ01425SEJA	68
1AJ36BNXXXXX05XJA	153	1AJ36DKT80008BXJA	81	1AJ37BNXXX4505XJA	155	1AJ37JRJ014205EJA	68
1AJ36BNXXX8BXJA	153	1AJ36DKT80308BXJA	81	1AJ37BNXXX4518XJA	155	1AJ37JRJ014218EJA	68
1AJ36BNXXXXX46XJA	153	1AJ36DKT80358BXJA	81	1AJ37BNXXXX5SXJA	155	1AJ37JRJ37425SEJA	64
1AJ36BNXXXXX98XJA	153	1AJ36DKT800005XJA	81	1AJ37BNXXXX05XJA	155	1AJ37JRJ374205EJA	64
1AJ36BYXXX451MXJA	154	1AJ36DKT800046XJA	81	1AJ37BNXXXX18XJA	155	1AJ37JRJ374218EJA	64
1AJ36BYXXX458BXJA	154	1AJ36DKT800098XJA	81	1AJ37BYXXX455SXJA	156	1AJ37MRJ01315SEJA	68
1AJ36BYXXX4505XJA	154	1AJ36DKT803005XJA	81	1AJ37BYXXX4505XJA	156	1AJ37MRJ01325SEJA	68
1AJ36BYXXX4546XJA	154	1AJ36DKT803046XJA	81	1AJ37BYXXX4518XJA	156	1AJ37MRJ013105EJA	68
1AJ36BYXXX4598XJA	154	1AJ36DKT803098XJA	81	1AJ37BYXXXX5SXJA	156	1AJ37MRJ013118EJA	68
1AJ36BYXXXG98XJA	242	1AJ36DKT803505XJA	81	1AJ37BYXXXX05XJA	156	1AJ37MRJ013205EJA	68
1AJ36BYXXXXX1MXJA	153	1AJ36DKT803546XJA	81	1AJ37BYXXXX18XJA	156	1AJ37MRJ013218EJA	68
1AJ36BYXXXXX05XJA	153	1AJ36DKT803598XJA	81	1AJ37CMXXX525SCJA	136	1AJ37MRJ37315SEJA	64
1AJ36BYXXXXX8BXJA	153	1AJ36ID006588BCJA	137	1AJ37CMXXX5205CJA	136	1AJ37MRJ37325SEJA	64
1AJ36BYXXXXX46XJA	153	1AJ36ID0065805CJA	137	1AJ37CMXXX5218CJA	136	1AJ37MRJ373105EJA	64
1AJ36BYXXXXX98XJA	153	1AJ36ID0065846CJA	137	1AJ37DKC80005SXJA	69	1AJ37MRJ373118EJA	64
1AJ36CMXXX528BCJA	137	1AJ36ID0065898CJA	137	1AJ37DKC80305SXJA	69	1AJ37MRJ373205EJA	64
1AJ36CMXXX5205CJA	137	1AJ36IPI06588BCJA	137	1AJ37DKC80355SXJA	69	1AJ37MRJ373218EJA	64
1AJ36CMXXX5246CJA	137	1AJ36IPI065805CJA	137	1AJ37DKC800005XJA	69	1AJ37PMJ20325SJJA	68
1AJ36CMXXX5298CJA	137	1AJ36IPI065846CJA	137	1AJ37DKC800018XJA	69	1AJ37PMJ20325SLJA	68
1AJ36DKC80008BXJA	80	1AJ36IPI065898CJA	137	1AJ37DKC803005XJA	69	1AJ37PMJ38325SJJA	64
1AJ36DKC80308BXJA	80	1AJ36IS006588BCJA	137	1AJ37DKC803018XJA	69	1AJ37PMJ38325SLJA	64
1AJ36DKC80358BXJA	80	1AJ36IS0065805CJA	137	1AJ37DKC803505XJA	69	1AJ37PMJ203205JJA	68

CODE	PAG
1AJ37PMJ203205LJA	68
1AJ37PMJ203218JJA	68
1AJ37PMJ203218LJA	68
1AJ37PMJ383205JJA	64
1AJ37PMJ383205LJA	64
1AJ37PMJ383218JJA	64
1AJ37PMJ383218LJA	64
1AJ37RO0FP455SXJA	156
1AJ37RO0FP4505XJA	156
1AJ37RO0FP4518XJA	156
1AJ37ROXXX455SXJA	156
1AJ37ROXXX4505XJA	156
1AJ37ROXXX4518XJA	156
1AJ37ROXXXXX5SXJA	156
1AJ37ROXXXXX05XJA	156
1AJ37ROXXXXX18XJA	156
1AJ40CMXXX5218CZA	408
1AJ40DK0150018XZA	330
1AJ40DK0153018XZA	330
1AJ40DK0153518XZA	330
1AJ40DK0753018XZA	331
1AJ40DK0753518XZA	331
1AJ40DK0755018XZA	331
1AJ40DKC800018XZA	331
1AJ40DKC803018XZA	331
1AJ40DKC803518XZA	331
1AJ40DKC810018XZA	327
1AJ40DKC813018XZA	327
1AJ40DKC813518XZA	327
1AJ40DKQ150018XZA	326
1AJ40DKQ153018XZA	326
1AJ40DKQ153518XZA	326
1AJ40DKQ753018XZA	327
1AJ40DKQ753518XZA	327
1AJ40DKQ755018XZA	327
1AJ40DKT800018XZA	331
1AJ40DKT803018XZA	331
1AJ40DKT803518XZA	331
1AJ40DKT810018XZA	327
1AJ40DKT813018XZA	327
1AJ40DKT813518XZA	327
1AJ40ID0066318CZA	408
1AJ40IP066318CZA	408
1AJ40IS0066318CZA	408
1AJ40MR0223118CZA	334
1AJ40MR0223218CZA	334
1AJ40MRD173118ZZA	330
1AJ40MRD173218ZZA	330
1AJ40MRD73118ZZA	326
1AJ40MRQD73218ZZA	326
1AJ40PMD013218YZA	330
1AJ40PMD033218YZA	326
1AJ40RGD174218ZZA	330
1AJ40RQD74218ZZA	326
1AJ40RW0224218BZA	334
1AJ50BYXXXXX5SXJA	235
1AJ50BYXXXXX18XJA	235
1AJ50BYXXXXX46XJA	235
1AJ50KPXXXN250XJA	244
1AJ50KPXXXN25SXJA	244
1AJ50KPXXXN550XJA	244
1AJ50KPXXXN55SXJA	244
1AJ50KPXXXN205XJA	244
1AJ50KPXXXN246XJA	244
1AJ50KPXXXN505XJA	244
1AJ50KPXXXN546XJA	244
1AJ51CDXXXXX3DXXX	173

CODE	PAG
1AJ51KP220131MXJA	249
1AJ51KP220151MXJA	249
1AJ51KP2201305XJA	249
1AJ51KP2201318XJA	249
1AJ51KP2201346XJA	249
1AJ51KP2201398XJA	249
1AJ51KP2201505XJA	249
1AJ51KP2201518XJA	249
1AJ51KP2201546XJA	249
1AJ51KP2201598XJA	249
1AJ52CDXXXXX3DXXX	173
1AJ52KPXXXN25SXJA	243
1AJ52KPXXXN55SXJA	243
1AJ52KPXXXN205XJA	243
1AJ52KPXXXN505XJA	243
1AJ53CDXXXXX3DXXX	173
1AJ53KPXXX1305XJA	247
1AJ53KPXXX1398XJA	247
1AJ53KPXXX1505XJA	247
1AJ53KPXXX1598XJA	247
1AJ53KPXXXN205XJA	245
1AJ53KPXXXN218XJA	245
1AJ53KPXXXN505XJA	245
1AJ53KPXXXN518XJA	245
1AJ54CDXXXXX3DXXX	173
1AJ55CDXXXXX3DXXX	173
1AJ56CDXXXXX3DXXX	173
1AJ56KPXXX1305XJA	249
1AJ56KPXXX1346XJA	249
1AJ56KPXXX1398XJA	249
1AJ56KPXXX1505XJA	249
1AJ56KPXXX1546XJA	249
1AJ56KPXXX1598XJA	249
1AJ57CDXXXXX3DXXX	173
1AJ57KPXXX1305XJA	247
1AJ57KPXXX1346XJA	247
1AJ57KPXXX1505XJA	247
1AJ57KPXXX1546XJA	247
1AJ57KPXXXN205XJA	245
1AJ57KPXXXN246XJA	245
1AJ57KPXXXN298XJA	245
1AJ57KPXXXN505XJA	245
1AJ57KPXXXN546XJA	245
1AJ57KPXXXN598XJA	245
1AJ58CDXXXXX3DXXX	173
1AJ59CDXXXXX3DXXX	173
1AJ60KPXXXN25SXJA	244
1AJ60KPXXXN55SXJA	244
1AJ61KP2201398XJA	250
1AJ61KP2201598XJA	250
1AJ62KPXXXN25SXJA	243
1AJ62KPXXXN55SXJA	243
1AJ62KPXXXN246XJA	243
1AJ62KPXXXN546XJA	243
1AJ63KPXXXN205XJA	246
1AJ63KPXXXN218XJA	246
1AJ63KPXXXN246XJA	246
1AJ63KPXXXN505XJA	246
1AJ63KPXXXN518XJA	246
1AJ63KPXXXN546XJA	246
1AJ71BNXXXXX31XXI	450
1AJ71CDXXXXX3DXXX	174
1AJ71KPXXX131MXJA	250
1AJ71KPXXX151MXJA	250
1AJ71KPXXX1305XJA	250
1AJ71KPXXX1318XJA	250
1AJ71KPXXX1346XJA	250

CODE	PAG
1AJ71KPXXX1398XJA	250
1AJ71KPXXX1505XJA	250
1AJ71KPXXX1518XJA	250
1AJ71KPXXX1546XJA	250
1AJ71KPXXX1598XJA	250
1AJ72CDXXXXX3DXXX	174
1AJ73BNXXXXX02XXI	450
1AJ73BNXXXXXK1XXI	450
1AJ73CDXXXXX3DXXX	174
1AJ73KPXXX131MXJA	248
1AJ73KPXXX151MXJA	248
1AJ73KPXXX1305XJA	248
1AJ73KPXXX1346XJA	248
1AJ73KPXXX1398XJA	248
1AJ73KPXXX1505XJA	248
1AJ73KPXXX1546XJA	248
1AJ73KPXXX1598XJA	248
1AJ73KPXXXN205XJA	246
1AJ73KPXXXN246XJA	246
1AJ73KPXXXN298XJA	246
1AJ73KPXXXN505XJA	246
1AJ73KPXXXN546XJA	246
1AJ73KPXXXN598XJA	246
1AJ74CDXXXXX3DXXX	174
1AJ75CDXXXXX3DXXX	174
1AJ76CDXXXXX3DXXX	174
1AJ77CDXXXXX3DXXX	174
1AJ78CDXXXXX3DXXX	174
1AJ79CDXXXXX3DXXX	174
1AJ80CDXXXXX3DXXX	174
1AJ81CDXXXXX3DXXX	174
1AJ82CDXXXXX3DXXX	174
1AJQ5BYXXXXX5SXJA	235
1AJQ5BYXXXXX18XJA	235
1AQ13PI002XX05XJA	261
1AQ13PI002XX05XJA	263
1AQ13PI002XX05XJA	429
1AQ13PI002XX18XJA	261
1AQ13PI002XX18XJA	429
1AQ13PI002XX18XJA	431
1AQ13PI002XX31XJA	429
1AQ13PI002XX46XJA	261
1AQ13PI002XX98XJA	261
1AQ13PI002XXX1XJA	261
1AQ16MLXXCP4CXXA	418
1AR21SRXXXXX05XXA	440
1AR21SRXXXXX31XXA	440
1AR22SRXXXXX05XXA	440
1AR22SRXXXXX31XXA	440
1AR23SRXXXXX05XXA	440
1AR23SRXXXXX31XXA	440
1AR41INXXXXX5SXXA	439
1AR41SRXXXXX5SXXA	439
1AR42SRXXXXX5SXXA	439
1AR43SRXXXXX5SXXA	439
1AR44SRXXXXX5SXXA	439
1AR51INXXXXX5SXXA	438
1AR51SRXXXXX5SXXA	438
1AR52SRXXXXX5SXXA	438
1AR53SRXXXXX5SXXA	438
1AR54SRXXXXX5SXXA	438

COD	PAG	COD	PAG	COD	PAG	COD	PAG
000-006-A00-999	176	000-786-000-999	178	002-D17-Y01-180	344	004-Q09-031-180	315
000-007-A00-999	176	000-787-000-999	178	002-T80-00E-180	345	004-Q09-032-000	315
000-031-000-999	170	000-788-000-999	178	002-T80-10E-180	345	004-Q09-032-180	315
000-070-000-999	177	000-789-000-999	178	002-T80-20E-180	345	004-Q09-900-000	315
000-072-000-999	177	000-791-000-999	178	004-009-031-000	321	004-Q09-900-180	315
000-077-000-999	177	000-792-000-999	178	004-009-031-180	321	004-Q75-030-000	316
000-078-000-999	177	000-800-030-999	172	004-009-032-000	321	004-Q75-030-180	316
000-081-A00-999	177	000-800-035-999	172	004-009-032-180	321	004-Q75-035-000	316
000-082-000-999	177	000-800-040-999	172	004-075-030-000	322	004-Q75-035-180	316
000-086-A00-999	177	000-800-045-999	172	004-075-030-180	322	004-Q75-050-000	316
000-088-A00-999	177	000-800-050-999	172	004-075-035-000	322	004-Q75-050-180	316
000-090-A00-999	175	000-800-055-999	172	004-075-035-180	322	004-QD7-031-000	314
000-093-A00-999	175	000-800-060-999	172	004-075-050-000	322	004-QD7-031-180	314
000-094-A00-999	175	000-800-065-999	172	004-075-050-180	322	004-QD7-032-000	314
000-095-A00-999	177	000-800-070-999	172	004-411-000-000	321	004-QD7-032-180	314
000-096-A00-999	177	000-800-075-999	172	004-411-000-180	321	004-QD7-900-000	314
000-097-A00-999	175	000-800-080-999	172	004-411-110-000	321	004-QD7-900-180	314
000-100-A00-999	177	000-800-085-999	172	004-411-110-180	321	004-QD7-Y03-000	314
000-105-A00-999	177	000-826-735-999	419	004-411-200-000	321	004-QD7-Y03-180	314
000-108-A00-999	176	000-826-737-999	419	004-411-200-180	321	004-T01-031-000	320
000-109-A00-999	176	000-826-745-999	419	004-511-000-000	315	004-T01-031-180	320
000-110-000-999	177	000-826-747-999	419	004-511-000-180	315	004-T01-032-000	320
000-113-000-999	177	000-826-755-999	419	004-511-0TE-000	317	004-T01-032-180	320
000-120-000-999	178	000-826-757-999	419	004-511-0TE-180	317	004-T01-900-000	320
000-127-000-999	178	000-826-765-999	419	004-511-1TE-000	317	004-T01-900-180	320
000-139-000-999	178	000-826-767-999	419	004-511-1TE-180	317	004-T80-00E-000	323
000-141-000-999	170	000-826-775-999	419	004-511-2TE-000	317	004-T80-00E-180	323
000-141-000-999	170	000-826-777-999	419	004-511-2TE-180	317	004-T80-10E-000	323
000-141-A00-999	171	000-826-785-999	419	004-511-110-000	315	004-T80-10E-180	323
000-142-000-999	171	000-826-787-999	419	004-511-110-180	315	004-T80-20E-000	323
000-159-000-999	178	001-009-031-000	348	004-511-200-000	315	004-T80-20E-180	323
000-161-000-999	178	001-009-032-000	348	004-511-200-180	315	004-T81-00E-000	317
000-162-000-999	178	001-009-900-000	348	004-706-500-000	408	004-T81-00E-180	317
000-256-A00-999	175	001-075-030-000	350	004-706-500-180	408	004-T81-10E-000	317
000-257-A00-999	175	001-075-035-000	350	004-716-000-000	408	004-T81-10E-180	317
000-258-A00-999	175	001-075-050-000	350	004-716-000-180	408	004-T81-20E-000	317
000-259-A00-999	175	001-411-000-000	349	004-716-300-000	408	004-T81-20E-180	317
000-260-A00-999	175	001-411-110-000	349	004-716-300-180	408	10N-300-0MD-0NO	422
000-261-A00-999	175	001-411-200-000	349	004-716-400-000	408	10N-300-0MD-0NR	422
000-262-A00-999	176	001-706-500-000	410	004-716-400-180	408	10N-300-0MD-0NW	422
000-263-A00-999	176	001-716-300-000	410	004-C80-00E-000	322	10N-511-000-0NO	366
000-264-A00-999	176	001-716-400-000	410	004-C80-00E-180	322	10N-511-000-0NR	366
000-265-A00-999	176	001-C80-00E-000	350	004-C80-10E-000	322	10N-511-000-0NW	366
000-266-A00-999	176	001-C80-10E-000	350	004-C80-10E-180	322	10N-511-110-0NO	366
000-267-A00-999	176	001-C80-20E-000	350	004-C80-20E-000	322	10N-511-110-0NR	366
000-268-A00-999	176	001-D17-031-000	348	004-C80-20E-180	322	10N-511-110-0NW	366
000-269-A00-999	175	001-D17-032-000	348	004-C81-00E-000	316	10N-511-200-0NO	366
000-270-A00-999	175	001-D17-900-000	348	004-C81-00E-180	316	10N-511-200-0NR	366
000-271-A00-999	175	001-T80-00E-000	351	004-C81-10E-000	316	10N-511-200-0NW	366
000-274-A00-999	176	001-T80-10E-000	351	004-C81-10E-180	316	10N-600-0MD-0NO	423
000-275-A00-999	176	001-T80-20E-000	351	004-C81-20E-000	316	10N-600-0MD-0NR	423
000-276-A00-999	176	002-075-030-180	345	004-C81-20E-180	316	10N-600-0MD-0NW	423
000-296-000-999	170	002-075-035-180	345	004-D17-031-000	320	10N-C81-00E-0NR	367
000-297-000-999	170	002-075-050-180	345	004-D17-031-180	320	10N-C81-00E-0NW	367
000-298-000-999	170	002-411-000-180	344	004-D17-032-000	320	10N-C81-10E-0NR	367
000-299-000-999	170	002-411-110-180	344	004-D17-032-180	320	10N-C81-10E-0NW	367
000-387-000-000	251	002-411-200-180	344	004-D17-900-000	320	10N-C81-20E-0NR	367
000-387-000-055	251	002-706-500-180	409	004-D17-900-180	320	10N-C81-20E-0NW	367
000-387-000-155	251	002-716-000-180	409	004-D17-Y01-000	320	10N-D1N-071-0NO	366
000-387-000-367	251	002-716-300-180	409	004-D17-Y01-180	320	10N-D1N-071-0NR	366
000-388-000-000	251	002-716-400-180	409	004-Q01-031-000	314	10N-D1N-071-0NW	366
000-388-000-01M	251	002-C80-00E-180	345	004-Q01-031-180	314	10N-D1N-072-0NO	366
000-388-000-066	251	002-C80-10E-180	345	004-Q01-032-000	314	10N-D1N-072-0NR	366
000-388-000-180	251	002-C80-20E-180	345	004-Q01-032-180	314	10N-D1N-072-0NW	366
000-388-000-367	251	002-D17-031-180	344	004-Q01-900-000	314	10N-D1N-985-0NO	366
000-783-000-999	178	002-D17-032-180	344	004-Q01-900-180	314	10N-D1N-985-0NR	366
000-784-000-999	178	002-D17-900-180	344	004-Q09-031-000	315	10N-D1N-985-0NW	366

COD	PAG	COD	PAG	COD	PAG	COD	PAG
10N-T81-00E-0NR	367	040-716-000-01M	407	069-411-200-08E	276	069-D17-Y56-059	276
10N-T81-00E-0NW	367	040-716-000-047	407	069-411-200-08N	276	069-D17-Y56-065	276
10N-T81-10E-0NR	367	040-716-300-0BQ	407	069-411-200-054	276	069-D17-Y56-085	276
10N-T81-10E-0NW	367	040-716-300-01M	407	069-411-200-059	276	069-T80-00E-08E	277
10N-T81-20E-0NR	367	040-716-300-047	407	069-411-200-085	276	069-T80-00E-08N	277
10N-T81-20E-0NW	367	040-716-400-0BQ	407	069-706-500-08E	404	069-T80-00E-054	277
018-195-064-999	171	040-716-400-01M	407	069-706-500-08N	404	069-T80-00E-059	277
040-009-031-0BQ	308	040-C80-00E-0BQ	310	069-706-500-054	404	069-T80-00E-065	277
040-009-031-01M	308	040-C80-00E-01M	310	069-706-500-059	404	069-T80-00E-085	277
040-009-031-047	308	040-C80-00E-047	310	069-706-500-065	404	069-T80-10E-08E	277
040-009-032-0BQ	308	040-C80-10E-0BQ	310	069-706-500-085	404	069-T80-10E-08N	277
040-009-032-01M	308	040-C80-10E-01M	310	069-716-000-08E	404	069-T80-10E-054	277
040-009-900-0BQ	308	040-C80-10E-047	310	069-716-000-08N	404	069-T80-10E-059	277
040-009-900-01M	308	040-C80-20E-0BQ	310	069-716-000-054	404	069-T80-10E-065	277
040-009-900-047	308	040-C80-20E-01M	310	069-716-000-059	404	069-T80-10E-085	277
040-040-006-0BQ	309	040-C80-20E-047	310	069-716-000-065	404	069-T80-20E-08E	277
040-040-006-01M	309	040-D17-031-0BQ	308	069-716-000-085	404	069-T80-20E-08N	277
040-040-006-047	309	040-D17-031-01M	308	069-716-300-08E	404	069-T80-20E-054	277
040-040-013-0BQ	309	040-D17-031-047	308	069-716-300-08N	404	069-T80-20E-059	277
040-040-013-01M	309	040-D17-032-0BQ	308	069-716-300-054	404	069-T80-20E-065	277
040-040-013-047	309	040-D17-032-01M	308	069-716-300-059	404	069-T80-20E-085	277
040-040-600-0BQ	309	040-D17-032-047	308	069-716-300-065	404	070-037-000-001	450
040-040-600-01M	309	040-D17-900-0BQ	308	069-716-300-085	404	070-037-000-004	450
040-040-600-047	309	040-D17-900-01M	308	069-716-400-08E	404	80C-009-031-01M	286
040-040-D13-0BQ	309	040-D17-900-047	308	069-716-400-08E	404	80C-009-031-08F	286
040-040-D13-01M	309	040-D17-Y56-0BQ	308	069-716-400-08N	404	80C-009-031-047	286
040-040-D13-047	309	040-D17-Y56-01M	308	069-716-400-054	404	80C-009-032-01M	286
040-040-L13-0BQ	407	040-D17-Y56-047	308	069-716-400-065	404	80C-009-032-08F	286
040-040-L13-047	407	040-T80-00E-0BQ	310	069-716-400-085	404	80C-009-032-047	286
040-040-R13-0BQ	407	040-T80-00E-01M	310	069-C80-00E-08E	277	80C-009-900-01M	286
040-040-R13-01M	407	040-T80-00E-047	310	069-C80-00E-08N	277	80C-009-900-08F	286
040-040-R13-047	407	040-T80-10E-0BQ	310	069-C80-00E-054	277	80C-009-900-047	286
040-040-S13-0BQ	309	040-T80-10E-01M	310	069-C80-00E-065	277	80C-040-006-01M	287
040-040-S13-01M	309	040-T80-10E-047	310	069-C80-00E-085	277	80C-040-006-08F	287
040-040-S13-047	309	040-T80-20E-0BQ	310	069-C80-10E-08E	277	80C-040-006-047	287
040-075-030-0BQ	310	040-T80-20E-01M	310	069-C80-10E-08N	277	80C-040-013-01M	287
040-075-030-01M	310	040-T80-20E-047	310	069-C80-10E-054	277	80C-040-013-08F	287
040-075-030-047	310	054-013-000-044	450	069-C80-10E-059	277	80C-040-013-047	287
040-075-035-0BQ	310	069-075-030-08E	277	069-C80-10E-065	277	80C-040-600-01M	287
040-075-035-01M	310	069-075-030-08N	277	069-C80-10E-085	277	80C-040-600-08F	287
040-075-035-047	310	069-075-030-054	277	069-C80-20E-08E	277	80C-040-600-047	287
040-075-050-0BQ	310	069-075-030-059	277	069-C80-20E-08N	277	80C-040-D13-01M	287
040-075-050-01M	310	069-075-030-065	277	069-C80-20E-054	277	80C-040-D13-08F	287
040-075-050-047	310	069-075-030-085	277	069-C80-20E-059	277	80C-040-D13-047	287
040-411-000-0BQ	309	069-075-035-08E	277	069-C80-20E-065	277	80C-040-S13-01M	287
040-411-000-01M	309	069-075-035-08N	277	069-C80-20E-085	277	80C-040-S13-08F	287
040-411-000-047	309	069-075-035-054	277	069-D17-031-08E	276	80C-075-030-01M	288
040-411-0T0-0BQ	311	069-075-035-059	277	069-D17-031-08N	276	80C-075-030-08F	288
040-411-0T0-01M	311	069-075-035-065	277	069-D17-031-054	276	80C-075-030-047	288
040-411-0T0-047	311	069-075-035-085	277	069-D17-031-059	276	80C-075-035-01M	288
040-411-1T0-0BQ	311	069-075-050-08E	277	069-D17-031-065	276	80C-075-035-08F	288
040-411-1T0-01M	311	069-075-050-08N	277	069-D17-031-085	276	80C-075-035-047	288
040-411-1T0-047	311	069-075-050-054	277	069-D17-032-08E	276	80C-075-050-01M	288
040-411-2T0-0BQ	311	069-075-050-059	277	069-D17-032-08N	276	80C-075-050-08F	288
040-411-2T0-01M	311	069-075-050-065	277	069-D17-032-054	276	80C-075-050-047	288
040-411-2T0-047	311	069-075-050-085	277	069-D17-032-059	276	80C-411-000-01M	288
040-411-110-0BQ	309	069-411-000-08E	276	069-D17-032-065	276	80C-411-000-08F	288
040-411-110-01M	309	069-411-000-08N	276	069-D17-032-085	276	80C-411-000-047	288
040-411-110-047	309	069-411-000-054	276	069-D17-900-08E	276	80C-411-110-01M	288
040-411-200-0BQ	309	069-411-000-059	276	069-D17-900-08N	276	80C-411-110-08F	288
040-411-200-01M	309	069-411-000-065	276	069-D17-900-054	276	80C-411-110-047	288
040-411-200-047	309	069-411-000-085	276	069-D17-900-059	276	80C-411-200-01M	288
040-706-400-047	407	069-411-110-08E	276	069-D17-900-065	276	80C-411-200-08F	288
040-706-500-0BQ	407	069-411-110-08N	276	069-D17-900-085	276	80C-411-200-047	288
040-706-500-01M	407	069-411-110-054	276	069-D17-Y56-08E	276	80C-706-500-01M	406
040-706-500-047	407	069-411-110-059	276	069-D17-Y56-08N	276	80C-706-500-08F	406
040-716-000-0BQ	407	069-411-110-065	276	069-D17-Y56-054	276	80C-706-500-047	406

COD	PAG	COD	PAG	COD	PAG	COD	PAG
80C-716-000-01M	406	90C-075-035-01M	272	101-706-400-367	405	124-QD7-031-000	376
80C-716-000-08F	406	90C-075-035-047	272	101-716-000-000	405	124-QD7-031-180	376
80C-716-000-047	406	90C-075-050-0BQ	272	101-716-000-367	405	124-QD7-032-000	376
80C-716-300-01M	406	90C-075-050-01M	272	101-716-300-000	405	124-QD7-032-180	376
80C-716-300-08F	406	90C-075-050-047	272	101-716-300-367	405	124-QD7-900-180	376
80C-716-300-047	406	90C-411-000-0BQ	272	101-716-400-000	405	124-QD7-Y03-000	376
80C-716-400-01M	406	90C-411-000-01M	272	101-716-400-367	405	124-QD7-Y03-180	376
80C-716-400-08F	406	90C-411-000-047	272	101-C80-0LE-000	282	124-T81-00E-000	377
80C-716-400-047	406	90C-411-110-0BQ	272	101-C80-0LE-367	282	124-T81-00E-180	377
80C-C80-00E-01M	289	90C-411-110-01M	272	101-C80-0RE-000	282	124-T81-10E-000	377
80C-C80-00E-08F	289	90C-411-110-047	272	101-C80-0RE-367	282	124-T81-10E-180	377
80C-C80-00E-047	289	90C-411-200-0BQ	272	101-C80-1LE-000	282	124-T81-20E-000	377
80C-C80-10E-01M	289	90C-411-200-01M	272	101-C80-1LE-367	282	124-T81-20E-180	377
80C-C80-10E-08F	289	90C-411-200-047	272	101-C80-1RE-000	282	125-025-000-000	446
80C-C80-10E-047	289	90C-706-500-0BQ	404	101-C80-1RE-367	282	125-025-000-044	446
80C-C80-20E-01M	289	90C-706-500-01M	404	101-C80-2LE-000	282	141-075-030-180	397
80C-C80-20E-08F	289	90C-706-500-047	404	101-C80-2LE-367	282	141-075-035-180	397
80C-C80-20E-047	289	90C-716-000-0BQ	404	101-C80-2RE-000	282	141-075-050-180	397
80C-D17-031-01M	286	90C-716-000-01M	404	101-C80-2RE-367	282	141-383-031-180	400
80C-D17-031-08F	286	90C-716-000-047	404	101-D17-031-000	280	141-383-032-180	400
80C-D17-031-047	286	90C-716-300-0BQ	404	101-D17-031-367	280	141-383-900-180	400
80C-D17-032-01M	286	90C-716-300-01M	404	101-D17-032-000	280	141-411-000-180	396
80C-D17-032-08F	286	90C-716-300-047	404	101-D17-032-367	280	141-411-110-180	396
80C-D17-032-047	286	90C-716-400-0BQ	404	101-D17-900-000	280	141-411-200-180	396
80C-D17-900-01M	286	90C-716-400-01M	404	101-D17-900-367	280	141-511-000-180	392
80C-D17-900-08F	286	90C-716-400-047	404	101-D17-L00-000	280	141-511-110-180	392
80C-D17-900-047	286	90C-C80-00E-01M	273	101-D17-L00-367	280	141-511-200-180	392
80C-D17-Y01-01M	286	90C-C80-00E-047	273	101-D17-R00-000	280	141-706-500-180	414
80C-D17-Y01-08F	286	90C-C80-10E-0BQ	273	101-D17-R00-367	280	141-716-000-180	414
80C-D17-Y01-047	286	90C-C80-10E-01M	273	101-T80-0LE-000	283	141-716-300-180	414
80C-T80-00E-01M	289	90C-C80-10E-047	273	101-T80-0LE-367	283	141-716-400-180	414
80C-T80-00E-08F	289	90C-C80-20E-0BQ	273	101-T80-0RE-000	283	141-C80-00E-180	397
80C-T80-00E-047	289	90C-C80-20E-01M	273	101-T80-0RE-367	283	141-C80-10E-180	397
80C-T80-10E-01M	289	90C-C80-20E-047	273	101-T80-1LE-000	283	141-C80-20E-180	397
80C-T80-10E-08F	289	90C-D17-031-0BQ	270	101-T80-1LE-367	283	141-C81-00E-180	393
80C-T80-10E-047	289	90C-D17-031-01M	270	101-T80-1RE-000	283	141-C81-10E-180	393
80C-T80-20E-01M	289	90C-D17-031-047	270	101-T80-1RE-367	283	141-C81-20E-180	393
80C-T80-20E-08F	289	90C-D17-032-0BQ	270	101-T80-2LE-000	283	141-D17-031-180	396
80C-T80-20E-047	289	90C-D17-032-01M	270	101-T80-2LE-367	283	141-D17-032-180	396
90C-009-031-0BQ	270	90C-D17-032-047	270	101-T80-2RE-000	283	141-D17-900-180	396
90C-009-031-01M	270	90C-D17-900-0BQ	270	101-T80-2RE-367	283	141-D17-Y01-180	396
90C-009-031-047	270	90C-D17-900-01M	270	124-511-000-000	376	141-Q75-030-180	393
90C-009-032-0BQ	270	90C-D17-900-047	270	124-511-000-180	376	141-Q75-035-180	393
90C-009-032-01M	270	90C-T80-00E-0BQ	273	124-511-110-000	376	141-Q75-050-180	393
90C-009-032-047	270	90C-T80-00E-01M	273	124-511-110-180	376	141-QD7-031-180	392
90C-009-900-0BQ	270	90C-T80-00E-047	273	124-511-200-000	376	141-QD7-032-180	392
90C-009-900-01M	270	90C-T80-10E-0BQ	273	124-511-200-180	376	141-QD7-900-180	392
90C-009-900-047	270	90C-T80-10E-01M	273	124-706-500-000	412	141-QD7-Y03-180	392
90C-040-006-0BQ	271	90C-T80-10E-047	273	124-706-500-180	412	141-T80-00E-180	397
90C-040-006-01M	271	90C-T80-20E-0BQ	273	124-716-000-000	412	141-T80-10E-180	397
90C-040-006-047	271	90C-T80-20E-01M	273	124-716-000-180	412	141-T80-20E-180	397
90C-040-013-0BQ	271	90C-T80-20E-047	273	124-716-300-000	412	141-T81-00E-180	393
90C-040-013-01M	271	101-433-000-000	281	124-716-300-180	412	141-T81-10E-180	393
90C-040-013-047	271	101-433-000-367	281	124-716-400-000	412	141-T81-20E-180	393
90C-040-600-0BQ	271	101-433-110-000	281	124-716-400-180	412	168-039-006-0P7	381
90C-040-600-01M	271	101-433-110-367	281	124-C81-00E-000	377	168-039-006-061	381
90C-040-600-047	271	101-433-200-000	281	124-C81-00E-180	377	168-039-013-0P7	381
90C-040-D13-0BQ	271	101-433-200-367	281	124-C81-10E-000	377	168-039-013-061	381
90C-040-D13-01M	271	101-434-000-000	281	124-C81-10E-180	377	168-039-600-0P7	381
90C-040-D13-047	271	101-434-000-367	281	124-C81-20E-000	377	168-039-600-061	381
90C-040-S13-0BQ	271	101-434-110-000	281	124-C81-20E-180	377	168-039-D13-0P7	381
90C-040-S13-01M	271	101-434-110-367	281	124-Q75-030-000	377	168-039-D13-061	381
90C-040-S13-047	271	101-434-200-000	281	124-Q75-030-180	377	168-039-L13-0P7	413
90C-075-030-0BQ	272	101-434-200-367	281	124-Q75-035-000	377	168-039-L13-061	413
90C-075-030-01M	272	101-706-300-000	405	124-Q75-035-180	377	168-039-R13-0P7	413
90C-075-030-047	272	101-706-300-367	405	124-Q75-050-000	377	168-039-R13-061	413
90C-075-035-0BQ	272	101-706-400-000	405	124-Q75-050-180	377	168-039-S13-0P7	381

COD	PAG	COD	PAG	COD	PAG	COD	PAG
168-039-S13-061	381	168-D17-Y56-0P7	380	180-C80-20E-180	341	265-025-000-001	447
168-075-030-0P4	382	168-D17-Y56-061	380	180-D17-031-000	338	265-032-000-001	447
168-075-030-0P6	382	168-T80-00E-0P4	383	180-D17-031-01M	338	266-030-000-001	447
168-075-030-0P7	382	168-T80-00E-0P6	383	180-D17-031-180	338	286-040-000-004	448
168-075-030-061	382	168-T80-00E-0P7	383	180-D17-032-000	338	318-050-000-022	448
168-075-035-0P4	382	168-T80-00E-061	383	180-D17-032-01M	338	318-050-000-285	448
168-075-035-0P6	382	168-T80-10E-0P4	383	180-D17-032-180	338	320-045-000-285	449
168-075-035-0P7	382	168-T80-10E-0P6	383	180-D17-900-000	338	324-085-000-285	449
168-075-035-061	382	168-T80-10E-0P7	383	180-D17-900-01M	338	342-125-000-000	434
168-075-050-0P4	382	168-T80-10E-061	383	180-D17-900-180	338	342-125-000-001	434
168-075-050-0P6	382	168-T80-20E-0P4	383	180-D17-Y01-000	338	342-125-000-055	434
168-075-050-0P7	382	168-T80-20E-0P6	383	180-D17-Y01-01M	338	342-125-100-000	434
168-075-050-061	382	168-T80-20E-0P7	383	180-D17-Y01-180	338	342-125-100-001	434
168-411-000-0P4	382	168-T80-20E-061	383	180-T80-00E-000	341	342-125-100-055	434
168-411-000-0P6	382	180-040-006-000	339	180-T80-00E-01M	341	343-472-200-066	250
168-411-000-0P7	382	180-040-006-01M	339	180-T80-00E-180	341	343-492-200-066	250
168-411-000-061	382	180-040-006-180	339	180-T80-10E-000	341	351-420-072-000	211
168-411-110-0P4	382	180-040-013-000	339	180-T80-10E-01M	341	351-420-072-066	211
168-411-110-0P6	382	180-040-013-01M	339	180-T80-10E-180	341	351-420-072-367	211
168-411-110-0P7	382	180-040-013-180	339	180-T80-20E-000	341	351-420-092-000	211
168-411-110-061	382	180-040-600-000	339	180-T80-20E-01M	341	351-420-092-066	211
168-411-200-0P4	382	180-040-600-01M	339	180-T80-20E-180	341	351-420-092-367	211
168-411-200-0P6	382	180-040-600-180	339	260-009-031-180	299	351-421-472-000	213
168-411-200-0P7	382	180-040-D13-000	339	260-009-032-180	299	351-421-472-066	213
168-411-200-061	382	180-040-D13-01M	339	260-009-900-180	299	351-421-472-367	213
168-706-500-0P4	413	180-040-D13-180	339	260-075-030-180	300	351-421-492-000	213
168-706-500-0P6	413	180-040-S13-000	339	260-075-035-180	300	351-421-492-066	213
168-706-500-0P7	413	180-040-S13-01M	339	260-075-050-180	300	351-421-492-367	213
168-706-500-061	413	180-040-S13-180	339	260-383-031-180	304	351-421-572-000	213
168-716-000-0P4	413	180-075-030-000	340	260-383-032-180	304	351-421-572-066	213
168-716-000-0P6	413	180-075-030-01M	340	260-383-900-180	304	351-421-572-367	213
168-716-000-0P7	413	180-075-030-180	340	260-411-000-180	300	351-421-592-000	213
168-716-000-061	413	180-075-035-000	340	260-411-110-180	300	351-421-592-066	213
168-716-300-0P4	413	180-075-035-01M	340	260-411-200-180	300	351-421-592-367	213
168-716-300-0P6	413	180-075-035-180	340	260-511-000-180	294	351-922-072-000	215
168-716-300-0P7	413	180-075-050-000	340	260-511-110-180	294	351-922-072-066	215
168-716-300-061	413	180-075-050-01M	340	260-511-200-180	294	351-922-072-367	215
168-716-400-0P4	413	180-075-050-180	340	260-706-500-180	406	351-922-092-000	215
168-716-400-0P6	413	180-411-000-000	340	260-716-000-180	406	351-922-092-066	215
168-716-400-0P7	413	180-411-000-01M	340	260-716-300-180	406	351-922-092-367	215
168-716-400-061	413	180-411-000-180	340	260-716-400-180	406	351-X72-200-000	246
168-C80-00E-0P4	383	180-411-110-000	340	260-C80-00E-180	301	351-X72-200-066	246
168-C80-00E-0P6	383	180-411-110-01M	340	260-C80-10E-180	301	351-X72-200-367	246
168-C80-00E-0P7	383	180-411-110-180	340	260-C80-20E-180	301	351-X92-200-000	246
168-C80-00E-061	383	180-411-200-000	340	260-C81-00E-180	295	351-X92-200-066	246
168-C80-10E-0P4	383	180-411-200-01M	340	260-C81-10E-180	295	351-X92-200-367	246
168-C80-10E-0P6	383	180-411-200-180	340	260-C81-20E-180	295	352-872-200-000	248
168-C80-10E-0P7	383	180-706-500-000	409	260-D17-031-180	298	352-872-200-01M	248
168-C80-10E-061	383	180-706-500-01M	409	260-D17-032-180	298	352-872-200-066	248
168-C80-20E-0P4	383	180-706-500-180	409	260-D17-900-180	298	352-872-200-367	248
168-C80-20E-0P6	383	180-716-000-000	409	260-D17-Y01-180	298	352-892-200-000	248
168-C80-20E-0P7	383	180-716-000-01M	409	260-Q09-031-180	293	352-892-200-01M	248
168-C80-20E-061	383	180-716-000-180	409	260-Q09-032-180	293	352-892-200-066	248
168-D17-031-0P4	380	180-716-300-000	409	260-Q09-900-180	293	352-892-200-367	248
168-D17-031-0P6	380	180-716-300-01M	409	260-Q75-030-180	294	353-472-200-000	250
168-D17-031-0P7	380	180-716-300-180	409	260-Q75-035-180	294	353-472-200-01M	250
168-D17-031-061	380	180-716-400-000	409	260-Q75-050-180	294	353-472-200-066	250
168-D17-032-0P4	380	180-716-400-01M	409	260-QD7-031-180	292	353-472-200-180	250
168-D17-032-0P6	380	180-716-400-180	409	260-QD7-032-180	292	353-472-200-367	250
168-D17-032-0P7	380	180-C80-00E-000	341	260-QD7-900-180	292	353-492-200-000	250
168-D17-032-061	380	180-C80-00E-01M	341	260-QD7-Y03-180	292	353-492-200-01M	250
168-D17-900-0P4	380	180-C80-00E-180	341	260-T80-00E-180	301	353-492-200-066	250
168-D17-900-0P6	380	180-C80-10E-000	341	260-T80-10E-180	301	353-492-200-180	250
168-D17-900-0P7	380	180-C80-10E-01M	341	260-T80-20E-180	301	353-492-200-367	250
168-D17-900-061	380	180-C80-10E-180	341	260-T81-00E-180	295	354-000-000-000	165
168-D17-Y56-0P4	380	180-C80-20E-000	341	260-T81-10E-180	295	354-000-000-066	165
168-D17-Y56-0P6	380	180-C80-20E-01M	341	260-T81-20E-180	295	354-000-000-367	165

COD	PAG	COD	PAG	COD	PAG	COD	PAG
354-072-100-000	165	368-373-A00-000	104	368-C80-20E-055	105	371-154-500-055	151
354-072-100-066	165	368-373-A00-055	104	368-C80-20E-180	105	371-154-500-180	151
354-072-100-367	165	368-373-A00-180	104	368-C81-00E-000	100	371-163-000-000	152
354-072-200-000	165	368-373-B00-000	104	368-C81-00E-055	100	371-163-000-055	152
354-072-200-066	165	368-373-B00-055	104	368-C81-00E-180	100	371-164-000-000	152
354-072-200-367	165	368-373-B00-180	104	368-C81-10E-000	100	371-164-000-004	152
354-420-072-000	225	368-373-C00-000	104	368-C81-10E-055	100	371-164-000-055	152
354-420-072-01M	225	368-373-C00-057	104	368-C81-10E-180	100	371-164-000-180	152
354-420-072-066	225	368-373-C00-180	104	368-C81-20E-000	100	371-164-000-367	152
354-420-072-367	225	368-373-D00-000	104	368-C81-20E-055	100	371-164-400-000	151
354-420-092-000	225	368-373-D00-057	104	368-C81-20E-180	100	371-164-400-055	151
354-420-092-01M	225	368-373-D00-180	104	368-T80-00E-000	105	371-373-072-000	219
354-420-092-066	225	368-373-E00-000	104	368-T80-00E-055	105	371-373-072-180	219
354-420-092-367	225	368-373-E00-057	104	368-T80-00E-180	105	371-373-092-000	219
354-421-472-000	227	368-373-E00-180	104	368-T80-10E-000	105	371-373-092-180	219
354-421-472-01M	227	368-388-A00-000	99	368-T80-10E-055	105	371-374-472-000	221
354-421-472-066	227	368-388-A00-055	99	368-T80-10E-180	105	371-374-472-180	221
354-421-472-367	227	368-388-A00-180	99	368-T80-20E-000	105	371-374-492-000	221
354-421-492-000	227	368-388-B00-000	99	368-T80-20E-055	105	371-374-492-180	221
354-421-492-01M	227	368-388-B00-055	99	368-T80-20E-180	105	371-374-572-000	221
354-421-492-066	227	368-388-B00-180	99	368-T81-00E-000	101	371-374-572-180	221
354-421-492-367	227	368-388-C00-000	99	368-T81-00E-055	101	371-374-592-000	221
354-421-572-000	227	368-388-C00-057	99	368-T81-00E-180	101	371-374-592-180	221
354-421-572-01M	227	368-388-C00-180	99	368-T81-10E-000	101	371-455-300-000	160
354-421-572-066	227	368-388-D00-000	99	368-T81-10E-055	101	371-455-300-055	160
354-421-572-367	227	368-388-D00-057	99	368-T81-10E-180	101	371-455-600-000	160
354-421-592-000	227	368-388-D00-180	99	368-T81-20E-000	101	371-455-600-055	160
354-421-592-01M	227	368-388-E00-000	99	368-T81-20E-055	101	371-855-200-055	235
354-421-592-066	227	368-388-E00-057	99	368-T81-20E-180	101	371-855-200-180	235
354-421-592-367	227	368-388-E00-180	99	370-374-472-000	229	371-855-500-055	234
354-991-100-000	161	368-510-00E-000	104	370-374-472-066	229	371-855-500-180	234
354-991-100-066	161	368-510-00E-057	104	370-374-492-000	229	371-991-400-000	160
354-991-100-367	161	368-510-00E-180	104	370-374-492-066	229	371-991-400-055	160
354-991-200-000	161	368-510-10E-000	104	370-374-572-000	229	373-0Q6-000-000	75
354-991-200-066	161	368-510-10E-057	104	370-374-572-066	229	373-0Q6-000-180	75
354-991-200-367	161	368-510-10E-180	104	370-374-592-000	229	373-1X3-000-055	240
356-000-000-000	169	368-510-20E-000	104	370-374-592-066	229	373-1X3-000-066	240
356-000-000-066	169	368-510-20E-057	104	371-1X3-000-000	240	373-1X3-000-367	240
356-072-100-000	169	368-510-20E-180	104	371-1X3-000-055	240	373-1X3-200-055	241
356-072-100-066	169	368-512-00E-000	100	371-1X3-000-066	240	373-1X3-200-066	241
356-072-200-000	169	368-512-00E-057	100	371-1X3-200-000	242	373-1X3-200-367	241
356-072-200-066	169	368-512-00E-180	100	371-1X3-200-055	242	373-064-000-000	143
356-991-100-000	163	368-512-10E-000	100	371-1X3-200-066	242	373-064-000-004	143
356-991-100-066	163	368-512-10E-057	100	371-064-000-000	152	373-064-000-055	143
356-991-200-000	163	368-512-10E-180	100	371-064-000-004	152	373-064-000-066	143
356-991-200-066	163	368-512-20E-000	100	371-064-000-055	152	373-064-000-180	143
361-420-072-000	217	368-512-20E-057	100	371-064-000-367	152	373-064-000-367	143
361-420-072-180	217	368-512-20E-180	100	371-153-000-000	151	373-153-000-000	142
361-420-072-367	217	368-708-500-000	139	371-153-000-055	151	373-153-000-004	142
361-420-092-000	217	368-708-500-055	139	371-153-100-000	151	373-153-000-055	142
361-420-092-180	217	368-708-500-180	139	371-153-100-055	151	373-153-000-066	142
361-420-092-367	217	368-718-000-000	139	371-153-200-000	151	373-153-100-000	142
368-371-A00-000	98	368-718-000-055	139	371-153-200-055	151	373-153-100-004	142
368-371-A00-055	98	368-718-000-180	139	371-153-200-180	151	373-153-100-055	142
368-371-A00-180	98	368-718-300-000	139	371-154-000-000	151	373-153-100-066	142
368-371-B00-000	98	368-718-300-055	139	371-154-000-055	151	373-153-200-000	142
368-371-B00-055	98	368-718-300-180	139	371-154-100-000	151	373-153-200-004	142
368-371-B00-180	98	368-718-400-000	139	371-154-100-055	151	373-153-200-055	142
368-371-C00-000	98	368-718-400-055	139	371-154-100-367	151	373-153-200-066	142
368-371-C00-057	98	368-718-400-180	139	371-154-200-000	152	373-153-200-180	142
368-371-C00-180	98	368-C80-00E-000	105	371-154-200-055	152	373-154-000-000	142
368-371-D00-000	98	368-C80-00E-055	105	371-154-200-180	152	373-154-000-004	142
368-371-D00-057	98	368-C80-00E-180	105	371-154-300-000	151	373-154-000-055	142
368-371-D00-180	98	368-C80-10E-000	105	371-154-300-055	151	373-154-000-066	142
368-371-E00-000	98	368-C80-10E-055	105	371-154-400-000	151	373-154-000-367	142
368-371-E00-057	98	368-C80-10E-180	105	371-154-400-055	151	373-154-100-000	142
368-371-E00-180	98	368-C80-20E-000	105	371-154-500-000	151	373-154-100-004	142

COD	PAG	COD	PAG	COD	PAG	COD	PAG
373-154-100-055	142	373-508-300-000	256	377-373-A00-180	68	377-T80-00E-180	69
373-154-100-066	142	373-508-300-180	256	377-373-B00-000	68	377-T80-10E-000	69
373-154-200-000	143	373-512-00E-000	74	377-373-B00-055	68	377-T80-10E-055	69
373-154-200-004	143	373-512-00E-180	74	377-373-B00-180	68	377-T80-10E-180	69
373-154-200-055	143	373-512-0TE-000	75	377-373-C00-000	68	377-T80-20E-000	69
373-154-200-066	143	373-512-0TE-180	75	377-373-C00-057	68	377-T80-20E-055	69
373-154-300-000	142	373-512-1TE-000	75	377-373-C00-180	68	377-T80-20E-180	69
373-154-300-004	142	373-512-1TE-180	75	377-373-D00-000	68	381-388-A00-066	60
373-154-300-055	142	373-512-2TE-000	75	377-373-D00-057	68	381-388-A00-180	60
373-154-300-066	142	373-512-2TE-180	75	377-373-D00-180	68	381-388-B00-066	60
373-154-400-000	142	373-512-10E-000	74	377-373-E00-000	68	381-388-B00-180	60
373-154-400-004	142	373-512-10E-180	74	377-373-E00-057	68	381-388-C00-066	60
373-154-400-055	142	373-512-20E-000	74	377-373-E00-180	68	381-388-C00-180	60
373-154-400-066	142	373-512-20E-180	74	377-388-A00-000	64	381-388-D00-066	60
373-154-500-000	142	373-708-500-000	137	377-388-A00-055	64	381-388-D00-180	60
373-154-500-004	142	373-708-500-180	137	377-388-A00-180	64	381-388-E00-066	60
373-154-500-055	142	373-718-000-000	137	377-388-B00-000	64	381-388-E00-180	60
373-154-500-066	142	373-718-000-180	137	377-388-B00-055	64	383-050-000-000	415
373-163-000-000	143	373-718-300-000	137	377-388-B00-180	64	383-050-000-180	415
373-163-000-004	143	373-718-300-180	137	377-388-C00-000	64	383-050-200-000	415
373-163-000-055	143	373-718-400-000	137	377-388-C00-057	64	383-050-200-180	415
373-163-000-066	143	373-718-400-180	137	377-388-C00-180	64	383-060-000-000	415
373-163-000-180	143	373-855-200-055	235	377-388-D00-000	64	383-060-000-180	415
373-164-000-000	143	373-855-200-180	235	377-388-D00-057	64	383-503-600-180	417
373-164-000-004	143	373-855-200-367	235	377-388-D00-180	64	388-153-000-000	155
373-164-000-055	143	373-855-500-055	234	377-388-E00-000	64	388-153-000-055	155
373-164-000-066	143	373-855-500-180	234	377-388-E00-057	64	388-153-000-180	155
373-164-000-367	143	373-855-500-367	234	377-388-E00-180	64	388-153-100-000	155
373-164-000-367	143	373-964-100-000	72	377-410-00E-000	65	388-153-100-055	155
373-164-400-000	142	373-964-100-180	72	377-410-00E-057	65	388-153-100-180	155
373-164-400-004	142	373-964-200-000	72	377-410-00E-180	65	388-153-200-000	156
373-164-400-055	142	373-964-200-180	72	377-410-10E-000	65	388-153-200-055	156
373-164-400-066	142	373-964-300-000	73	377-410-10E-057	65	388-153-200-180	156
373-164-400-180	142	373-964-300-180	73	377-410-10E-180	65	388-154-000-000	155
373-310-00E-000	73	373-964-400-000	73	377-410-20E-000	65	388-154-000-055	155
373-310-00E-180	73	373-964-400-180	73	377-410-20E-057	65	388-154-000-180	155
373-310-10E-000	73	373-964-600-000	73	377-410-20E-180	65	388-154-100-000	155
373-310-10E-180	73	373-964-600-180	73	377-510-00E-000	68	388-154-100-055	155
373-310-20E-000	73	373-991-400-000	159	377-510-00E-057	68	388-154-100-180	155
373-310-20E-180	73	373-991-400-055	159	377-510-00E-180	68	388-154-200-000	156
373-371-A00-000	72	373-C81-00E-000	74	377-510-10E-000	68	388-154-200-055	156
373-371-A00-180	72	373-C81-00E-180	74	377-510-10E-057	68	388-154-200-180	156
373-371-B00-000	72	373-C81-10E-000	74	377-510-10E-180	68	388-154-300-000	155
373-371-B00-180	72	373-C81-10E-180	74	377-510-20E-000	68	388-154-300-055	155
373-371-C00-000	72	373-C81-20E-000	74	377-510-20E-057	68	388-154-300-180	155
373-371-C00-180	72	373-C81-20E-180	74	377-510-20E-180	68	388-154-400-000	155
373-371-D00-000	72	373-T81-00E-000	74	377-708-500-000	136	388-154-400-055	155
373-371-D00-180	72	373-T81-00E-180	74	377-708-500-055	136	388-154-400-180	155
373-371-E00-000	72	373-T81-10E-000	74	377-708-500-180	136	388-154-500-000	155
373-371-E00-180	72	373-T81-10E-180	74	377-718-000-000	136	388-154-500-055	155
373-371-K00-000	256	373-T81-20E-000	74	377-718-000-055	136	388-154-500-180	155
373-371-K00-180	256	373-T81-20E-180	74	377-718-000-180	136	388-163-000-000	156
373-371-K00-367	256	373-TQ6-000-000	75	377-718-300-000	136	388-163-000-055	156
373-410-00E-000	73	373-TQ6-000-180	75	377-718-400-000	136	388-163-000-180	156
373-410-00E-180	73	374-508-000-180	238	377-718-400-180	136	388-164-000-000	156
373-410-10E-000	73	374-508-000-367	238	377-718-400-180	136	388-164-000-055	156
373-410-10E-180	73	377-310-00E-000	65	377-C80-00E-000	69	388-164-000-180	156
373-410-20E-000	73	377-310-00E-057	65	377-C80-00E-055	69	388-164-100-000	156
373-410-20E-180	73	377-310-00E-180	65	377-C80-00E-180	69	388-164-100-055	156
373-455-300-000	159	377-310-10E-000	65	377-C80-10E-000	69	388-164-100-180	156
373-455-300-055	159	377-310-10E-057	65	377-C80-10E-055	69	388-164-400-000	155
373-455-300-180	159	377-310-10E-180	65	377-C80-10E-180	69	388-164-400-055	155
373-455-600-000	159	377-310-20E-000	65	377-C80-20E-000	69	388-164-400-180	155
373-455-600-055	159	377-310-20E-057	65	377-C80-20E-055	69	388-455-300-000	160
373-508-000-000	237	377-310-20E-180	65	377-C80-20E-180	69	388-455-300-055	160
373-508-000-066	237	377-373-A00-000	68	377-T80-00E-000	69	388-455-300-180	160
373-508-000-180	237	377-373-A00-055	68	377-T80-00E-055	69	388-455-600-000	160

COD	PAG	COD	PAG	COD	PAG	COD	PAG
388-455-600-055	160	402-373-D00-057	34	402-708-500-055	134	402-C80-20E-004	36
388-455-600-180	160	402-373-D00-180	34	402-708-500-180	134	402-C80-20E-057	36
388-991-400-000	160	402-373-D00-367	34	402-708-500-367	134	402-C80-20E-180	36
388-991-400-055	160	402-373-E00-000	34	402-718-000-000	134	402-C80-20E-367	36
388-991-400-180	160	402-373-E00-004	34	402-718-000-004	134	402-C81-00E-000	27
400-018-200-055	441	402-373-E00-057	34	402-718-000-055	134	402-C81-00E-004	27
400-018-303-055	441	402-373-E00-180	34	402-718-000-180	134	402-C81-00E-057	27
400-090-320-47	308	402-373-E00-367	34	402-718-000-367	134	402-C81-00E-180	27
402-0Q6-000-000	31	402-410-00E-000	35	402-718-300-000	134	402-C81-00E-367	27
402-0Q6-000-367	31	402-410-00E-004	35	402-718-300-004	134	402-C81-10E-000	27
402-310-00E-000	36	402-410-00E-057	35	402-718-300-180	134	402-C81-10E-004	27
402-310-00E-004	36	402-410-00E-180	35	402-718-300-367	134	402-C81-10E-057	27
402-310-00E-057	36	402-410-00E-367	35	402-718-400-000	134	402-C81-10E-180	27
402-310-00E-180	36	402-410-10E-000	35	402-718-400-004	134	402-C81-10E-367	27
402-310-00E-367	36	402-410-10E-004	35	402-718-400-180	134	402-C81-20E-000	27
402-310-10E-000	36	402-410-10E-057	35	402-718-400-367	134	402-C81-20E-004	27
402-310-10E-004	36	402-410-10E-180	35	402-963-A00-000	30	402-C81-20E-057	27
402-310-10E-057	36	402-410-10E-367	35	402-963-A00-004	30	402-C81-20E-180	27
402-310-10E-180	36	402-410-20E-000	35	402-963-A00-057	30	402-C81-20E-367	27
402-310-10E-367	36	402-410-20E-004	35	402-963-A00-367	30	402-T80-00E-000	37
402-310-20E-000	36	402-410-20E-057	35	402-963-B00-000	30	402-T80-00E-004	37
402-310-20E-004	36	402-410-20E-180	35	402-963-B00-004	30	402-T80-00E-057	37
402-310-20E-057	36	402-410-20E-367	35	402-963-B00-057	30	402-T80-00E-180	37
402-310-20E-180	36	402-510-00E-000	35	402-963-B00-367	30	402-T80-00E-367	37
402-310-20E-367	36	402-510-00E-004	35	402-963-E00-000	30	402-T80-10E-000	37
402-371-A00-000	26	402-510-00E-057	35	402-963-E00-004	30	402-T80-10E-004	37
402-371-A00-004	26	402-510-00E-180	35	402-963-E00-057	30	402-T80-10E-057	37
402-371-A00-055	26	402-510-00E-367	35	402-963-E00-367	30	402-T80-10E-180	37
402-371-A00-180	26	402-510-10E-000	35	402-963-G00-000	30	402-T80-10E-367	37
402-371-A00-367	26	402-510-10E-004	35	402-963-G00-004	30	402-T80-20E-000	37
402-371-B00-000	26	402-510-10E-057	35	402-963-G00-057	30	402-T80-20E-004	37
402-371-B00-004	26	402-510-10E-180	35	402-963-G00-367	30	402-T80-20E-057	37
402-371-B00-055	26	402-510-10E-367	35	402-963-H00-000	30	402-T80-20E-180	37
402-371-B00-180	26	402-510-20E-000	35	402-963-H00-004	30	402-T80-20E-367	37
402-371-B00-367	26	402-510-20E-004	35	402-963-H00-057	30	402-T81-00E-000	27
402-371-E00-000	26	402-510-20E-057	35	402-963-H00-367	30	402-T81-00E-004	27
402-371-E00-004	26	402-510-20E-180	35	402-964-100-000	30	402-T81-00E-057	27
402-371-E00-057	26	402-510-20E-367	35	402-964-100-004	30	402-T81-00E-180	27
402-371-E00-180	26	402-512-00E-000	26	402-964-100-057	30	402-T81-00E-367	27
402-371-E00-367	26	402-512-00E-004	26	402-964-100-367	30	402-T81-10E-000	27
402-371-G00-000	26	402-512-00E-057	26	402-964-200-000	30	402-T81-10E-004	27
402-371-G00-004	26	402-512-00E-180	26	402-964-200-004	30	402-T81-10E-057	27
402-371-G00-057	26	402-512-00E-367	26	402-964-200-057	30	402-T81-10E-180	27
402-371-G00-180	26	402-512-0TE-000	27	402-964-200-367	30	402-T81-10E-367	27
402-371-G00-367	26	402-512-0TE-004	27	402-964-600-000	31	402-T81-20E-000	27
402-371-H00-000	26	402-512-0TE-180	27	402-964-600-004	31	402-T81-20E-004	27
402-371-H00-004	26	402-512-0TE-367	27	402-964-600-057	31	402-T81-20E-057	27
402-371-H00-057	26	402-512-1TE-000	27	402-964-600-367	31	402-T81-20E-180	27
402-371-H00-180	26	402-512-1TE-004	27	402-964-700-000	31	402-T81-20E-367	27
402-371-H00-367	26	402-512-1TE-180	27	402-964-700-004	31	402-TQ6-000-000	31
402-373-A00-000	34	402-512-1TE-367	27	402-964-700-057	31	402-TQ6-000-367	31
402-373-A00-004	34	402-512-2TE-000	27	402-964-700-367	31	408-039-000-044	442
402-373-A00-055	34	402-512-2TE-004	27	402-964-800-000	31	409-002-000-044	442
402-373-A00-180	34	402-512-2TE-180	27	402-964-800-004	31	409-008-000-055	438
402-373-A00-367	34	402-512-2TE-367	27	402-964-800-057	31	409-018-100-055	438
402-373-B00-000	34	402-512-10E-000	26	402-964-800-367	31	409-018-200-055	438
402-373-B00-004	34	402-512-10E-004	26	402-C80-00E-000	36	409-018-300-055	438
402-373-B00-055	34	402-512-10E-057	26	402-C80-00E-004	36	409-018-400-055	438
402-373-B00-180	34	402-512-10E-180	26	402-C80-00E-057	36	409-318-100-000	440
402-373-B00-367	34	402-512-10E-367	26	402-C80-00E-180	36	409-318-200-000	440
402-373-C00-000	34	402-512-20E-000	26	402-C80-00E-367	36	409-318-300-000	440
402-373-C00-004	34	402-512-20E-004	26	402-C80-10E-000	36	409-508-000-055	439
402-373-C00-057	34	402-512-20E-057	26	402-C80-10E-004	36	409-518-100-055	439
402-373-C00-180	34	402-512-20E-180	26	402-C80-10E-057	36	409-518-200-055	439
402-373-C00-367	34	402-512-20E-367	26	402-C80-10E-180	36	409-518-300-055	439
402-373-D00-000	34	402-708-500-000	134	402-C80-10E-367	36	409-518-400-055	439
402-373-D00-004	34	402-708-500-004	134	402-C80-20E-000	36	416-354-100-000	88

COD	PAG	COD	PAG	COD	PAG	COD	PAG
416-354-100-066	88	416-C80-10E-055	90	420-508-300-000	254	428-164-000-444	154
416-354-100-367	88	416-C80-10E-066	90	420-508-300-066	254	428-164-400-000	153
416-354-200-000	88	416-C80-10E-367	90	420-508-300-367	254	428-164-400-01M	153
416-354-200-066	88	416-C80-20E-000	90	421-000-000-000	239	428-164-400-066	153
416-354-200-367	88	416-C80-20E-055	90	421-000-000-066	239	428-164-400-367	153
416-354-300-000	89	416-C80-20E-066	90	421-000-000-367	239	428-164-400-444	153
416-354-300-066	89	416-C80-20E-367	90	428-1X3-000-066	241	428-310-00E-000	80
416-354-300-367	89	416-T80-00E-000	91	428-1X3-200-066	242	428-310-00E-066	80
416-354-400-000	89	416-T80-00E-055	91	428-064-000-000	154	428-310-00E-367	80
416-354-400-066	89	416-T80-00E-066	91	428-064-000-01M	154	428-310-00E-444	80
416-354-400-367	89	416-T80-00E-367	91	428-064-000-066	154	428-310-10E-000	80
416-354-600-000	89	416-T80-10E-000	91	428-064-000-367	154	428-310-10E-066	80
416-354-600-066	89	416-T80-10E-055	91	428-064-000-444	154	428-310-10E-367	80
416-354-600-367	89	416-T80-10E-066	91	428-153-000-000	153	428-310-10E-444	80
416-510-000-000	90	416-T80-10E-367	91	428-153-000-01M	153	428-310-20E-000	80
416-510-000-057	90	416-T80-20E-000	91	428-153-000-066	153	428-310-20E-066	80
416-510-000-066	90	416-T80-20E-055	91	428-153-000-367	153	428-310-20E-367	80
416-510-000-367	90	416-T80-20E-066	91	428-153-000-444	153	428-310-20E-444	80
416-510-110-000	90	416-T80-20E-367	91	428-153-100-000	153	428-410-00E-000	79
416-510-110-057	90	417-310-00E-002	85	428-153-100-01M	153	428-410-00E-066	79
416-510-110-066	90	417-310-00E-280	85	428-153-100-066	153	428-410-00E-367	79
416-510-110-367	90	417-310-10E-002	85	428-153-100-367	153	428-410-00E-444	79
416-510-200-000	90	417-310-10E-280	85	428-153-100-444	153	428-410-10E-000	79
416-510-200-057	90	417-310-20E-002	85	428-153-200-000	153	428-410-10E-066	79
416-510-200-066	90	417-310-20E-280	85	428-153-200-01M	153	428-410-10E-367	79
416-510-200-367	90	417-356-100-002	84	428-153-200-066	153	428-410-10E-444	79
416-708-500-000	138	417-356-100-280	84	428-153-200-367	153	428-410-20E-000	79
416-708-500-055	138	417-356-200-002	84	428-153-200-444	153	428-410-20E-066	79
416-708-500-066	138	417-356-200-280	84	428-154-000-000	153	428-410-20E-367	79
416-708-500-367	138	417-356-300-002	85	428-154-000-01M	153	428-410-20E-444	79
416-718-000-000	138	417-356-300-280	85	428-154-000-066	153	428-428-A00-000	78
416-718-000-055	138	417-356-400-002	85	428-154-000-367	153	428-428-A00-066	78
416-718-000-066	138	417-356-400-280	85	428-154-000-444	153	428-428-A00-367	78
416-718-000-367	138	417-356-600-002	85	428-154-100-000	153	428-428-A00-444	78
416-718-300-000	138	417-356-600-280	85	428-154-100-01M	153	428-428-B00-000	78
416-718-300-055	138	417-410-00E-002	85	428-154-100-066	153	428-428-B00-066	78
416-718-300-066	138	417-410-00E-280	85	428-154-100-367	153	428-428-B00-367	78
416-718-300-367	138	417-410-10E-002	85	428-154-100-444	153	428-428-B00-444	78
416-718-400-000	138	417-410-10E-280	85	428-154-200-000	154	428-428-C00-000	78
416-718-400-055	138	417-410-20E-002	85	428-154-200-01M	154	428-428-C00-066	78
416-718-400-066	138	417-410-20E-280	85	428-154-200-066	154	428-428-C00-367	78
416-718-400-367	138	417-708-500-002	138	428-154-200-367	154	428-428-C00-444	78
416-993-A00-000	88	417-708-500-280	138	428-154-200-444	154	428-428-D00-000	78
416-993-A00-055	88	417-718-000-002	138	428-154-300-000	153	428-428-D00-066	78
416-993-A00-066	88	417-718-000-280	138	428-154-300-01M	153	428-428-D00-367	78
416-993-A00-367	88	417-718-300-002	138	428-154-300-066	153	428-428-D00-444	78
416-993-B00-000	88	417-718-300-280	138	428-154-300-367	153	428-428-E00-000	78
416-993-B00-055	88	417-718-400-002	138	428-154-300-444	153	428-428-E00-066	78
416-993-B00-066	88	417-718-400-280	138	428-154-400-000	153	428-428-E00-367	78
416-993-B00-367	88	417-993-A00-002	84	428-154-400-01M	153	428-428-E00-444	78
416-993-C00-000	88	417-993-A00-280	84	428-154-400-066	153	428-510-00E-000	79
416-993-C00-055	88	417-993-B00-002	84	428-154-400-367	153	428-510-00E-066	79
416-993-C00-066	88	417-993-B00-280	84	428-154-400-444	153	428-510-00E-367	79
416-993-C00-367	88	417-993-C00-002	84	428-154-500-000	153	428-510-00E-444	79
416-993-D00-000	88	417-993-C00-280	84	428-154-500-01M	153	428-510-10E-000	79
416-993-D00-055	88	417-993-D00-002	84	428-154-500-066	153	428-510-10E-066	79
416-993-D00-066	88	417-993-D00-280	84	428-154-500-367	153	428-510-10E-367	79
416-993-D00-367	88	417-993-E00-002	84	428-154-500-444	153	428-510-10E-444	79
416-993-E00-000	88	417-993-E00-280	84	428-163-000-000	154	428-510-20E-000	79
416-993-E00-055	88	420-373-K00-000	254	428-163-000-01M	154	428-510-20E-066	79
416-993-E00-066	88	420-373-K00-066	254	428-163-000-066	154	428-510-20E-367	79
416-993-E00-367	88	420-373-K00-367	254	428-163-000-367	154	428-510-20E-444	79
416-C80-00E-000	90	420-508-000-000	236	428-163-000-444	154	428-708-500-000	137
416-C80-00E-055	90	420-508-000-01M	236	428-164-000-000	154	428-708-500-066	137
416-C80-00E-066	90	420-508-000-066	236	428-164-000-01M	154	428-708-500-367	137
416-C80-00E-367	90	420-508-000-180	236	428-164-000-066	154	428-708-500-444	137
416-C80-10E-000	90	420-508-000-367	236	428-164-000-367	154	428-718-000-000	137

COD	PAG	COD	PAG	COD	PAG	COD	PAG
428-718-000-066	137	444-411-110-036	362	462-C80-0RE-036	388	467-D17-900-040	370
428-718-000-367	137	444-411-200-010	362	462-C80-1LE-035	388	467-T80-0LE-040	373
428-718-000-444	137	444-411-200-035	362	462-C80-1LE-036	388	467-T80-0RE-040	373
428-718-300-000	137	444-411-200-036	362	462-C80-1RE-035	388	467-T80-1LE-040	373
428-718-300-066	137	444-706-500-010	411	462-C80-1RE-036	388	467-T80-1RE-040	373
428-718-300-367	137	444-706-500-035	411	462-C80-2LE-035	388	467-T80-2LE-040	373
428-718-300-444	137	444-706-500-036	411	462-C80-2LE-036	388	467-T80-2RE-040	373
428-718-400-000	137	444-716-300-010	411	462-C80-2RE-035	388	611-025-000-000	446
428-718-400-066	137	444-716-300-035	411	462-C80-2RE-036	388	611-025-000-001	446
428-718-400-367	137	444-716-300-036	411	462-D17-031-035	386	694-111-100-85	276
428-718-400-444	137	444-716-400-010	411	462-D17-031-036	386	694-112-000-65	276
428-991-300-000	158	444-716-400-035	411	462-D17-032-035	386	710-000-000-000	165
428-991-300-01M	158	444-716-400-036	411	462-D17-032-036	386	710-000-000-367	165
428-991-300-066	158	444-C80-00E-010	363	462-D17-300-035	386	710-072-100-000	165
428-991-300-367	158	444-C80-00E-035	363	462-D17-300-036	386	710-072-100-367	165
428-991-300-444	158	444-C80-00E-036	363	462-D17-400-035	386	710-072-200-000	165
428-991-400-000	158	444-C80-10E-010	363	462-D17-400-036	386	710-072-200-367	165
428-991-400-01M	158	444-C80-10E-035	363	462-D17-900-035	386	710-991-100-000	161
428-991-400-066	158	444-C80-10E-036	363	462-D17-900-036	386	710-991-100-367	161
428-991-400-367	158	444-C80-20E-010	363	462-T80-0LE-035	389	710-991-200-000	161
428-991-400-444	158	444-C80-20E-035	363	462-T80-0LE-036	389	710-991-200-367	161
428-991-600-000	158	444-C80-20E-036	363	462-T80-0RE-035	389	711-310-00E-000	95
428-991-600-01M	158	444-D17-031-010	362	462-T80-1LE-035	389	711-310-00E-367	95
428-991-600-066	158	444-D17-031-035	362	462-T80-1LE-036	389	711-310-10E-000	95
428-991-600-367	158	444-D17-031-036	362	462-T80-1RE-035	389	711-310-10E-367	95
428-991-600-444	158	444-D17-032-010	362	462-T80-1RE-036	389	711-310-20E-000	95
428-C80-00E-000	80	444-D17-032-035	362	462-T80-2LE-035	389	711-310-20E-367	95
428-C80-00E-066	80	444-D17-032-036	362	462-T80-2LE-036	389	711-410-00E-000	95
428-C80-00E-367	80	444-D17-900-010	362	462-T80-2RE-035	389	711-410-00E-367	95
428-C80-00E-444	80	444-D17-900-035	362	462-T80-2RE-036	389	711-410-10E-000	95
428-C80-10E-000	80	444-D17-900-036	362	463-075-030-035	359	711-410-10E-367	95
428-C80-10E-066	80	444-D17-Y01-010	362	463-075-050-035	359	711-410-20E-000	95
428-C80-10E-367	80	444-D17-Y01-035	362	463-116-000-035	410	711-410-20E-367	95
428-C80-10E-444	80	444-D17-Y01-036	362	463-411-000-035	358	711-428-A00-000	94
428-C80-20E-000	80	444-T80-00E-010	363	463-411-200-035	358	711-428-A00-367	94
428-C80-20E-066	80	444-T80-00E-035	363	463-706-500-035	410	711-428-B00-000	94
428-C80-20E-367	80	444-T80-00E-036	363	463-716-300-035	410	711-428-B00-367	94
428-C80-20E-444	80	444-T80-10E-010	363	463-716-400-035	410	711-428-C00-000	94
428-T80-00E-000	81	444-T80-10E-035	363	463-C80-00E-035	359	711-428-C00-367	94
428-T80-00E-066	81	444-T80-10E-036	363	463-C80-10E-035	359	711-428-D00-000	94
428-T80-00E-367	81	444-T80-20E-010	363	463-C80-20E-035	359	711-428-D00-367	94
428-T80-00E-444	81	444-T80-20E-035	363	463-D17-031-035	358	711-428-E00-000	94
428-T80-10E-000	81	444-T80-20E-036	363	463-D17-032-035	358	711-428-E00-367	94
428-T80-10E-066	81	453-000-000-000	257	463-D17-900-035	358	711-708-500-000	139
428-T80-10E-367	81	453-000-000-001	257	463-D17-Y01-035	358	711-708-500-367	139
428-T80-10E-444	81	453-040-000-000	257	463-QD7-031-035	354	711-710-100-000	94
428-T80-20E-000	81	462-116-000-035	414	463-QD7-032-035	354	711-710-100-367	94
428-T80-20E-066	81	462-116-000-036	414	463-QD7-900-035	354	711-710-200-000	94
428-T80-20E-367	81	462-433-000-035	387	463-QD7-Y03-035	354	711-710-200-367	94
428-T80-20E-444	81	462-433-000-036	387	463-T80-00E-035	359	711-710-300-000	95
444-075-030-010	363	462-433-110-035	387	463-T80-10E-035	359	711-710-300-367	95
444-075-030-035	363	462-433-110-036	387	463-T80-20E-035	359	711-710-400-000	95
444-075-030-036	363	462-433-200-035	387	467-116-000-040	412	711-710-400-367	95
444-075-035-010	363	462-433-200-036	387	467-706-300-040	412	711-710-600-000	95
444-075-035-035	363	462-434-000-035	387	467-706-400-040	412	711-710-600-367	95
444-075-035-036	363	462-434-000-036	387	467-716-300-040	412	711-718-000-000	139
444-075-050-010	363	462-434-110-035	387	467-716-400-040	412	711-718-000-367	139
444-075-050-035	363	462-434-110-036	387	467-C80-0LE-040	372	711-718-300-000	139
444-075-050-036	363	462-434-200-035	387	467-C80-0RE-040	372	711-718-300-367	139
444-116-000-010	411	462-434-200-036	387	467-C80-1LE-040	372	711-718-400-000	139
444-116-000-035	411	462-716-300-035	414	467-C80-1RE-040	372	711-718-400-367	139
444-116-000-036	411	462-716-300-036	414	467-C80-2LE-040	372	900-310-00E-000	56
444-411-000-010	362	462-716-400-035	414	467-C80-2RE-040	372	900-310-00E-066	56
444-411-000-035	362	462-716-400-036	414	467-D17-031-040	370	900-310-00E-367	56
444-411-000-036	362	462-C80-0LE-035	388	467-D17-032-040	370	900-310-00E-444	56
444-411-110-010	362	462-C80-0LE-036	388	467-D17-300-040	370	900-310-10E-000	56
444-411-110-035	362	462-C80-0RE-035	388	467-D17-400-040	370	900-310-10E-066	56

COD	PAG	COD	PAG	COD	PAG	COD	PAG
900-310-10E-367	56	900-993-A00-066	54	901-718-400-367	141	908-C80-2RE-367	48
900-310-10E-444	56	900-993-A00-367	54	901-951-100-000	128	908-T80-0LE-367	49
900-310-20E-000	56	900-993-A00-444	54	901-951-100-01M	128	908-T80-0RE-367	49
900-310-20E-066	56	900-993-B00-000	54	901-951-100-367	128	908-T80-1LE-367	49
900-310-20E-367	56	900-993-B00-066	54	901-951-200-000	128	908-T80-1RE-367	49
900-310-20E-444	56	900-993-B00-367	54	901-951-200-01M	128	908-T80-2LE-367	49
900-410-00E-000	56	900-993-B00-444	54	901-951-200-367	128	908-T80-2RE-367	49
900-410-00E-066	56	900-993-C00-000	54	901-951-300-000	129	913-000-000-000	238
900-410-00E-367	56	900-993-C00-066	54	901-951-300-01M	129	913-000-000-066	238
900-410-00E-444	56	900-993-C00-367	54	901-951-300-367	129	913-000-000-367	238
900-410-10E-000	56	900-993-C00-444	54	901-951-400-000	129	914-050-000-055	237
900-410-10E-066	56	900-993-D00-000	54	901-951-400-01M	129	922-373-K00-367	255
900-410-10E-367	56	900-993-D00-066	54	901-951-400-367	129	922-508-000-000	236
900-410-10E-444	56	900-993-D00-367	54	901-951-600-000	129	922-508-000-066	236
900-410-20E-000	56	900-993-D00-444	54	901-951-600-01M	129	922-508-000-367	236
900-410-20E-066	56	900-993-E00-000	54	901-951-600-367	129	922-508-300-000	255
900-410-20E-367	56	900-993-E00-066	54	904-000-000-000	131	922-508-300-367	255
900-410-20E-444	56	900-993-E00-367	54	904-000-000-367	51	933-310-00E-000	42
900-510-00E-000	55	900-993-E00-444	54	904-000-000-367	131	933-310-00E-367	42
900-510-00E-066	55	900-C80-00E-000	57	904-610-0TE-000	129	933-310-00E-444	42
900-510-00E-367	55	900-C80-00E-0BQ	273	904-610-0TE-367	50	933-310-10E-000	42
900-510-00E-444	55	900-C80-00E-066	57	904-610-0TE-367	129	933-310-10E-367	42
900-510-10E-000	55	900-C80-00E-367	57	904-610-1TE-000	129	933-310-10E-444	42
900-510-10E-066	55	900-C80-00E-444	57	904-610-1TE-367	50	933-310-20E-000	42
900-510-10E-367	55	900-C80-10E-000	57	904-610-1TE-367	129	933-310-20E-367	42
900-510-10E-444	55	900-C80-10E-066	57	904-610-2TE-000	129	933-310-20E-444	42
900-510-20E-000	55	900-C80-10E-367	57	904-610-2TE-367	50	933-410-00E-000	41
900-510-20E-066	55	900-C80-10E-444	57	904-610-2TE-367	129	933-410-00E-367	41
900-510-20E-367	55	900-C80-20E-000	57	904-C80-0TE-000	130	933-410-00E-444	41
900-510-20E-444	55	900-C80-20E-066	57	904-C80-0TE-367	50	933-410-10E-000	41
900-708-500-000	136	900-C80-20E-367	57	904-C80-0TE-367	130	933-410-10E-367	41
900-708-500-066	136	900-C80-20E-444	57	904-C80-1TE-000	130	933-410-10E-444	41
900-708-500-367	136	900-T80-00E-000	57	904-C80-1TE-367	50	933-410-20E-000	41
900-708-500-444	136	900-T80-00E-066	57	904-C80-1TE-367	130	933-410-20E-367	41
900-718-000-000	136	900-T80-00E-367	57	904-C80-2TE-000	130	933-410-20E-444	41
900-718-000-066	136	900-T80-00E-444	57	904-C80-2TE-367	50	933-708-500-000	134
900-718-000-367	136	900-T80-10E-000	57	904-C80-2TE-367	130	933-708-500-367	134
900-718-000-444	136	900-T80-10E-066	57	904-T80-0TE-000	130	933-708-500-444	134
900-718-300-000	136	900-T80-10E-367	57	904-T80-0TE-367	51	933-718-000-000	134
900-718-300-066	136	900-T80-10E-444	57	904-T80-0TE-367	130	933-718-000-367	134
900-718-300-367	136	900-T80-20E-000	57	904-T80-1TE-000	130	933-718-000-444	134
900-718-300-444	136	900-T80-20E-066	57	904-T80-1TE-367	51	933-718-300-000	134
900-718-400-000	136	900-T80-20E-367	57	904-T80-1TE-367	130	933-718-300-367	134
900-718-400-066	136	900-T80-20E-444	57	904-T80-2TE-000	130	933-718-300-444	134
900-718-400-367	136	901-428-A00-000	128	904-T80-2TE-367	51	933-718-400-000	134
900-718-400-444	136	901-428-A00-01M	128	904-T80-2TE-367	130	933-718-400-367	134
900-959-100-000	54	901-428-A00-367	128	908-613-00E-367	47	933-718-400-444	134
900-959-100-066	54	901-428-B00-000	128	908-613-10E-367	47	933-983-100-000	40
900-959-100-367	54	901-428-B00-01M	128	908-613-20E-367	47	933-983-100-367	40
900-959-100-444	54	901-428-B00-367	128	908-614-00E-367	47	933-983-100-444	40
900-959-200-000	54	901-428-C00-000	128	908-614-10E-367	47	933-983-200-000	40
900-959-200-066	54	901-428-C00-01M	128	908-614-20E-367	47	933-983-200-367	40
900-959-200-367	54	901-428-C00-367	128	908-708-300-367	135	933-983-200-444	40
900-959-200-444	54	901-428-D00-000	128	908-708-400-367	135	933-983-300-000	41
900-959-300-000	55	901-428-D00-01M	128	908-718-000-367	135	933-983-300-367	41
900-959-300-066	55	901-428-D00-367	128	908-718-300-367	135	933-983-300-444	41
900-959-300-367	55	901-428-E00-000	128	908-718-400-367	135	933-983-400-000	41
900-959-300-444	55	901-428-E00-01M	128	908-988-100-367	46	933-983-400-367	41
900-959-400-000	55	901-428-E00-367	128	908-988-200-367	46	933-983-400-444	41
900-959-400-066	55	901-718-000-000	141	908-988-300-367	46	933-983-600-000	41
900-959-400-367	55	901-718-000-01M	141	908-988-400-367	46	933-983-600-367	41
900-959-400-444	55	901-718-000-367	141	908-988-600-367	46	933-983-600-444	41
900-959-600-000	55	901-718-300-000	141	908-C80-0LE-367	48	933-984-A00-000	40
900-959-600-066	55	901-718-300-01M	141	908-C80-0RE-367	48	933-984-A00-367	40
900-959-600-367	55	901-718-300-367	141	908-C80-1LE-367	48	933-984-A00-444	40
900-959-600-444	55	901-718-400-000	141	908-C80-1RE-367	48	933-984-B00-000	40
900-993-A00-000	54	901-718-400-01M	141	908-C80-2LE-367	48	933-984-B00-367	40

COD	PAG	COD	PAG	COD	PAG	COD	PAG
933-984-B00-444	40	949-310-20E-118	124	949-510-20E-157	117	949-959-600-112	123
933-984-C00-000	40	949-310-20E-157	118	949-510-20E-367	110	949-959-600-118	123
933-984-C00-367	40	949-310-20E-367	111	949-708-500-000	140	949-959-600-367	109
933-984-C00-444	40	949-410-00E-000	110	949-708-500-002	141	949-990-100-000	109
933-984-D00-000	40	949-410-00E-002	124	949-708-500-004	140	949-990-100-002	123
933-984-D00-367	40	949-410-00E-004	110	949-708-500-008	141	949-990-100-008	123
933-984-D00-444	40	949-410-00E-008	124	949-708-500-012	141	949-990-100-012	123
933-984-E00-000	40	949-410-00E-012	124	949-708-500-018	141	949-990-100-018	123
933-984-E00-367	40	949-410-00E-018	124	949-708-500-055	140	949-990-100-112	123
933-984-E00-444	40	949-410-00E-057	117	949-708-500-112	141	949-990-100-118	123
933-C80-00E-000	42	949-410-00E-112	124	949-708-500-118	141	949-990-100-367	109
933-C80-00E-367	42	949-410-00E-118	124	949-708-500-367	140	949-990-200-000	109
933-C80-00E-444	42	949-410-00E-157	117	949-718-000-000	140	949-990-200-002	123
933-C80-10E-000	42	949-410-00E-367	110	949-718-000-002	141	949-990-200-008	123
933-C80-10E-367	42	949-410-10E-000	110	949-718-000-004	140	949-990-200-012	123
933-C80-10E-444	42	949-410-10E-002	124	949-718-000-008	141	949-990-200-018	123
933-C80-20E-000	42	949-410-10E-004	110	949-718-000-012	141	949-990-200-112	123
933-C80-20E-367	42	949-410-10E-008	124	949-718-000-018	141	949-990-200-118	123
933-C80-20E-444	42	949-410-10E-012	124	949-718-000-055	140	949-990-200-367	109
933-T80-00E-000	43	949-410-10E-018	124	949-718-000-112	141	949-990-300-000	109
933-T80-00E-367	43	949-410-10E-057	117	949-718-000-118	141	949-990-300-002	123
933-T80-00E-444	43	949-410-10E-112	124	949-718-000-367	140	949-990-300-008	123
933-T80-10E-000	43	949-410-10E-118	124	949-718-300-000	140	949-990-300-012	123
933-T80-10E-367	43	949-410-10E-157	117	949-718-300-002	141	949-990-300-018	123
933-T80-10E-444	43	949-410-10E-367	110	949-718-300-004	140	949-990-300-112	123
933-T80-20E-000	43	949-410-20E-000	110	949-718-300-008	141	949-990-300-118	123
933-T80-20E-367	43	949-410-20E-002	124	949-718-300-012	141	949-990-300-367	109
933-T80-20E-444	43	949-410-20E-004	110	949-718-300-018	141	949-990-400-000	109
940-000-000-000	434	949-410-20E-008	124	949-718-300-112	141	949-990-400-002	123
940-000-000-001	434	949-410-20E-012	124	949-718-300-118	141	949-990-400-008	123
940-000-100-000	434	949-410-20E-018	124	949-718-300-367	140	949-990-400-012	123
940-000-100-001	434	949-410-20E-057	117	949-718-400-000	140	949-990-400-018	123
940-000-200-000	434	949-410-20E-112	124	949-718-400-002	141	949-990-400-112	123
940-000-200-001	434	949-410-20E-118	124	949-718-400-004	140	949-990-400-118	123
949-000-000-000	112	949-410-20E-157	117	949-718-400-008	141	949-990-400-367	109
949-000-000-004	112	949-410-20E-367	110	949-718-400-012	141	949-990-600-000	109
949-000-000-367	112	949-510-00E-000	110	949-718-400-018	141	949-990-600-002	123
949-310-00E-000	111	949-510-00E-002	124	949-718-400-112	141	949-990-600-008	123
949-310-00E-002	124	949-510-00E-004	110	949-718-400-118	141	949-990-600-012	123
949-310-00E-004	111	949-510-00E-008	124	949-718-400-367	140	949-990-600-018	123
949-310-00E-008	124	949-510-00E-012	124	949-959-100-000	108	949-990-600-112	123
949-310-00E-012	124	949-510-00E-018	124	949-959-100-012	122	949-990-600-118	123
949-310-00E-018	124	949-510-00E-057	117	949-959-100-018	122	949-990-600-367	109
949-310-00E-057	118	949-510-00E-112	124	949-959-100-112	122	949-992-A00-000	108
949-310-00E-112	124	949-510-00E-118	124	949-959-100-118	122	949-992-A00-002	122
949-310-00E-118	124	949-510-00E-157	117	949-959-100-367	108	949-992-A00-004	108
949-310-00E-157	118	949-510-00E-367	110	949-959-200-000	108	949-992-A00-008	122
949-310-00E-367	111	949-510-10E-000	110	949-959-200-012	122	949-992-A00-012	122
949-310-10E-000	111	949-510-10E-002	124	949-959-200-018	122	949-992-A00-018	122
949-310-10E-002	124	949-510-10E-004	110	949-959-200-112	122	949-992-A00-112	122
949-310-10E-004	111	949-510-10E-008	124	949-959-200-118	122	949-992-A00-118	122
949-310-10E-008	124	949-510-10E-012	124	949-959-200-367	108	949-992-A00-367	108
949-310-10E-012	124	949-510-10E-018	124	949-959-300-000	109	949-992-B00-000	108
949-310-10E-018	124	949-510-10E-057	117	949-959-300-012	123	949-992-B00-002	122
949-310-10E-057	118	949-510-10E-112	124	949-959-300-018	123	949-992-B00-004	108
949-310-10E-112	124	949-510-10E-118	124	949-959-300-112	123	949-992-B00-008	122
949-310-10E-118	124	949-510-10E-157	117	949-959-300-118	123	949-992-B00-012	122
949-310-10E-157	118	949-510-10E-367	110	949-959-300-367	109	949-992-B00-018	122
949-310-10E-367	111	949-510-20E-000	110	949-959-400-000	109	949-992-B00-112	122
949-310-20E-000	111	949-510-20E-002	124	949-959-400-012	123	949-992-B00-118	122
949-310-20E-002	124	949-510-20E-004	110	949-959-400-018	123	949-992-B00-367	108
949-310-20E-004	111	949-510-20E-008	124	949-959-400-112	123	949-992-C00-000	108
949-310-20E-008	124	949-510-20E-012	124	949-959-400-118	123	949-992-C00-002	122
949-310-20E-012	124	949-510-20E-018	124	949-959-400-367	109	949-992-C00-004	108
949-310-20E-018	124	949-510-20E-057	117	949-959-600-000	109	949-992-C00-008	122
949-310-20E-057	118	949-510-20E-112	124	949-959-600-012	123	949-992-C00-012	122
949-310-20E-112	124	949-510-20E-118	124	949-959-600-018	123	949-992-C00-018	122

COD	PAG	COD	PAG	COD	PAG	COD	PAG
949-992-C00-112	122	949-T10-0TE-000	113	951-913-492-066	223	959-192-200-000	166
949-992-C00-118	122	949-T10-0TE-004	113	951-913-492-367	223	959-192-200-001	166
949-992-C00-367	108	949-T10-0TE-367	113	951-913-572-000	223	959-192-200-066	166
949-992-D00-000	108	949-T10-1TE-000	113	951-913-572-066	223	959-192-200-367	166
949-992-D00-002	122	949-T10-1TE-004	113	951-913-572-367	223	959-192-200-444	166
949-992-D00-004	108	949-T10-1TE-367	113	951-913-592-000	223	959-991-100-000	161
949-992-D00-008	122	949-T10-2TE-000	113	951-913-592-066	223	959-991-100-001	161
949-992-D00-012	122	949-T10-2TE-004	113	951-913-592-367	223	959-991-100-066	161
949-992-D00-018	122	949-T10-2TE-367	113	951-991-100-000	162	959-991-100-367	161
949-992-D00-112	122	949-T80-00E-000	112	951-991-100-01M	162	959-991-100-444	161
949-992-D00-118	122	949-T80-00E-002	125	951-991-100-367	162	959-991-200-000	161
949-992-D00-367	108	949-T80-00E-004	112	951-991-200-000	162	959-991-200-001	161
949-992-E00-000	108	949-T80-00E-008	125	951-991-200-01M	162	959-991-200-066	161
949-992-E00-002	122	949-T80-00E-012	125	951-991-200-367	162	959-991-200-367	161
949-992-E00-004	108	949-T80-00E-018	125	952-872-200-055	243	959-991-200-444	161
949-992-E00-008	122	949-T80-00E-055	119	952-872-200-367	243	962-472-200-000	249
949-992-E00-012	122	949-T80-00E-112	125	952-892-200-055	243	962-472-200-01M	249
949-992-E00-018	122	949-T80-00E-118	125	952-892-200-367	243	962-472-200-066	249
949-992-E00-112	122	949-T80-00E-155	119	952-914-472-057	183	962-472-200-180	249
949-992-E00-118	122	949-T80-00E-367	112	952-914-472-057	205	962-472-200-367	249
949-992-E00-367	108	949-T80-10E-000	112	952-914-472-157	183	962-492-200-000	249
949-993-A00-055	116	949-T80-10E-002	125	952-914-492-057	205	962-492-200-01M	249
949-993-A00-155	116	949-T80-10E-004	112	952-914-572-057	183	962-492-200-066	249
949-993-B00-055	116	949-T80-10E-008	125	952-914-572-057	205	962-492-200-180	249
949-993-B00-155	116	949-T80-10E-012	125	952-914-572-157	183	962-492-200-367	249
949-993-C00-057	116	949-T80-10E-018	125	952-914-592-057	205	963-153-000-000	146
949-993-C00-157	116	949-T80-10E-055	119	952-917-072-057	185	963-153-000-004	146
949-993-D00-057	116	949-T80-10E-112	125	952-917-072-157	185	963-153-000-066	146
949-993-D00-157	116	949-T80-10E-118	125	952-X72-200-055	244	963-153-000-367	146
949-993-E00-057	116	949-T80-10E-155	119	952-X92-200-055	244	963-153-100-000	146
949-993-E00-157	116	949-T80-10E-367	112	953-420-072-057	195	963-153-100-004	146
949-C80-00E-000	111	949-T80-20E-000	112	953-420-092-057	195	963-153-100-066	146
949-C80-00E-002	125	949-T80-20E-002	125	955-420-072-057	197	963-153-100-367	146
949-C80-00E-004	111	949-T80-20E-004	112	955-420-072-367	197	963-153-200-000	146
949-C80-00E-008	125	949-T80-20E-008	125	955-420-092-057	197	963-153-200-004	146
949-C80-00E-012	125	949-T80-20E-012	125	955-420-092-367	197	963-153-200-066	146
949-C80-00E-018	125	949-T80-20E-018	125	956-872-200-000	245	963-153-200-367	146
949-C80-00E-055	118	949-T80-20E-055	119	956-872-200-066	245	963-154-000-000	146
949-C80-00E-112	125	949-T80-20E-112	125	956-872-200-367	245	963-154-000-004	146
949-C80-00E-118	125	949-T80-20E-118	125	956-892-200-000	245	963-154-000-066	146
949-C80-00E-155	118	949-T80-20E-155	119	956-892-200-066	245	963-154-000-367	146
949-C80-00E-367	111	949-T80-20E-367	112	956-892-200-367	245	963-154-100-000	146
949-C80-10E-000	111	950-420-072-000	231	957-X72-200-000	246	963-154-100-004	146
949-C80-10E-002	125	950-420-072-367	231	957-X72-200-180	246	963-154-100-066	146
949-C80-10E-004	111	950-420-092-000	231	957-X72-200-367	246	963-154-100-367	146
949-C80-10E-008	125	950-420-092-367	231	957-X92-200-000	246	963-154-200-000	147
949-C80-10E-012	125	950-913-472-000	233	957-X92-200-180	246	963-154-200-004	147
949-C80-10E-018	125	950-913-472-367	233	957-X92-200-367	246	963-154-200-066	147
949-C80-10E-055	118	950-913-492-000	233	958-872-200-000	247	963-154-200-367	147
949-C80-10E-112	125	950-913-492-367	233	958-872-200-367	247	963-154-300-000	146
949-C80-10E-118	125	950-913-572-000	233	958-892-200-000	247	963-154-300-004	146
949-C80-10E-155	118	950-913-572-367	233	958-892-200-367	247	963-154-300-066	146
949-C80-10E-367	111	950-913-592-000	233	959-000-000-000	166	963-154-300-367	146
949-C80-20E-000	111	950-913-592-367	233	959-000-000-001	166	963-154-400-000	146
949-C80-20E-002	125	951-000-000-000	167	959-000-000-066	166	963-154-400-004	146
949-C80-20E-004	111	951-000-000-01M	167	959-000-000-367	166	963-154-400-066	146
949-C80-20E-008	125	951-000-000-367	167	959-000-000-444	166	963-154-400-367	146
949-C80-20E-012	125	951-072-100-000	167	959-072-100-000	166	963-154-500-000	146
949-C80-20E-018	125	951-072-100-01M	167	959-072-100-001	166	963-154-500-004	146
949-C80-20E-055	118	951-072-100-367	167	959-072-100-066	166	963-154-500-066	146
949-C80-20E-112	125	951-072-200-000	167	959-072-100-367	166	963-154-500-367	146
949-C80-20E-118	125	951-072-200-01M	167	959-072-100-444	166	963-163-000-000	147
949-C80-20E-155	118	951-072-200-367	167	959-072-200-000	166	963-163-000-004	147
949-C80-20E-367	111	951-913-472-000	223	959-072-200-001	166	963-163-000-066	147
949-T00-000-000	112	951-913-472-066	223	959-072-200-066	166	963-163-000-367	147
949-T00-000-004	112	951-913-472-367	223	959-072-200-367	166	963-164-000-000	147
949-T00-000-367	112	951-913-492-000	223	959-072-200-444	166	963-164-000-004	147

COD	PAG	COD	PAG	COD	PAG	COD	PAG
963-164-000-066	147	973-374-492-367	209	984-153-200-000	148	992-154-000-180	149
963-164-000-367	147	973-374-572-000	209	984-153-200-367	148	992-154-000-367	149
963-164-100-000	147	973-374-572-057	209	984-153-200-444	148	992-154-100-000	149
963-164-100-004	147	973-374-572-157	209	984-154-100-000	148	992-154-100-004	149
963-164-100-066	147	973-374-572-367	209	984-154-100-367	148	992-154-100-180	149
963-164-100-367	147	973-374-592-000	209	984-154-100-444	148	992-154-100-367	149
963-164-400-000	146	973-374-592-057	209	984-154-200-000	148	992-154-200-000	150
963-164-400-004	146	973-374-592-157	209	984-154-200-367	148	992-154-200-004	150
963-164-400-066	146	973-374-592-367	209	984-154-200-444	148	992-154-200-180	150
963-164-400-367	146	973-872-200-000	243	984-154-400-000	148	992-154-200-367	150
963-455-300-000	159	973-872-200-055	243	984-154-400-367	148	992-154-300-000	149
963-455-300-004	159	973-892-200-000	243	984-154-400-444	148	992-154-300-004	149
963-455-300-066	159	973-892-200-055	243	984-154-500-000	148	992-154-300-180	149
963-455-300-367	159	973-914-472-057	187	984-154-500-367	148	992-154-300-367	149
963-455-600-000	159	973-914-472-157	187	984-154-500-444	148	992-154-400-000	149
963-455-600-004	159	973-914-572-057	187	984-163-000-000	148	992-154-400-004	149
963-455-600-066	159	973-914-572-157	187	984-163-000-367	148	992-154-400-180	149
963-455-600-367	159	973-917-072-057	189	984-163-000-444	148	992-154-400-367	149
963-991-400-000	159	973-917-072-157	189	984-164-000-000	148	992-154-500-000	149
963-991-400-004	159	973-X72-200-000	244	984-164-000-367	148	992-154-500-004	149
963-991-400-066	159	973-X72-200-055	244	984-164-000-444	148	992-154-500-180	149
963-991-400-367	159	973-X72-200-155	244	984-164-400-000	148	992-154-500-367	149
964-000-000-000	169	973-X72-200-367	244	984-164-400-367	148	992-163-000-000	150
964-000-000-004	169	973-X92-200-000	244	984-164-400-444	148	992-163-000-004	150
964-000-000-066	169	973-X92-200-055	244	984-164-400-444	148	992-163-000-180	150
964-000-000-180	169	973-X92-200-155	244	984-991-C00-000	157	992-163-000-367	150
964-000-000-367	169	973-X92-200-367	244	984-991-C00-367	157	992-164-000-000	150
964-072-100-000	169	976-373-072-000	199	984-991-C00-444	157	992-164-000-004	150
964-072-100-004	169	976-373-072-057	199	984-991-D00-000	157	992-164-000-004	150
964-072-100-066	169	976-373-092-000	199	984-991-D00-367	157	992-164-000-180	150
964-072-100-180	169	976-373-092-057	199	984-991-D00-444	157	992-164-000-367	150
964-072-100-367	169	976-374-472-000	201	984-991-E00-000	157	992-164-100-000	150
964-072-200-000	169	976-374-472-057	201	984-991-E00-367	157	992-164-100-004	150
964-072-200-004	169	976-374-492-000	201	984-991-E00-444	157	992-164-100-180	150
964-072-200-066	169	976-374-492-057	201	988-000-000-367	167	992-164-100-367	150
964-072-200-180	169	976-374-572-000	201	988-072-100-367	167	992-164-400-000	149
964-072-200-367	169	976-374-572-057	201	988-072-200-367	167	992-164-400-004	149
964-125-000-000	434	976-374-592-000	201	988-991-100-367	162	992-164-400-180	149
964-125-100-000	434	976-374-592-057	201	988-991-200-367	162	992-164-400-367	149
964-192-200-000	169	977-X72-200-000	245	990-010-000-000	168	992-991-600-000	158
964-192-200-004	169	977-X72-200-180	245	990-010-000-001	168	992-991-600-004	158
964-192-200-066	169	977-X92-200-000	245	990-010-000-367	168	992-991-600-367	158
964-192-200-180	169	977-X92-200-180	245	990-072-100-000	168	992-991-700-000	158
964-192-200-367	169	978-872-200-000	247	990-072-100-001	168	992-991-700-004	158
964-455-100-000	164	978-872-200-066	247	990-072-100-367	168	992-991-700-367	158
964-455-100-004	164	978-892-200-000	247	990-072-200-000	168	992-991-900-000	158
964-455-100-066	164	978-892-200-066	247	990-072-200-001	168	992-991-900-004	158
964-455-100-367	164	982-922-072-057	191	990-072-200-367	168	992-991-900-367	158
964-991-200-000	164	982-922-072-157	191	990-991-100-000	163	993-1X3-000-055	240
964-991-200-004	164	983-000-000-000	166	990-991-100-01M	163	993-1X3-200-055	241
964-991-200-066	164	983-000-000-367	166	990-991-100-367	163	993-153-000-000	144
964-991-200-367	164	983-000-000-444	166	990-991-200-000	163	993-153-000-055	144
966-472-200-000	249	983-000-000-444	166	990-991-200-01M	163	993-153-000-066	144
966-472-200-066	249	983-072-100-000	166	990-991-200-367	163	993-153-000-367	144
966-472-200-367	249	983-072-100-367	166	992-153-000-000	149	993-153-000-444	144
966-492-200-000	249	983-072-100-444	166	992-153-000-004	149	993-153-100-000	144
966-492-200-066	249	983-072-200-000	166	992-153-000-180	149	993-153-100-055	144
966-492-200-367	249	983-072-200-367	166	992-153-000-367	149	993-153-100-066	144
973-373-072-057	207	983-072-200-444	166	992-153-100-000	149	993-153-100-155	144
973-373-092-057	207	983-991-100-000	162	992-153-100-004	149	993-153-100-367	144
973-374-472-000	209	983-991-100-367	162	992-153-100-180	149	993-153-100-444	144
973-374-472-057	209	983-991-100-444	162	992-153-100-367	149	993-153-200-000	144
973-374-472-157	209	983-991-200-000	162	992-153-200-000	149	993-153-200-055	144
973-374-472-367	209	983-991-200-367	162	992-153-200-004	149	993-153-200-066	144
973-374-492-000	209	983-991-200-444	162	992-153-200-180	149	993-153-200-155	144
973-374-492-057	209	984-153-100-000	148	992-153-200-367	149	993-153-200-367	144
973-374-492-157	209	984-153-100-367	148	992-154-000-000	149	993-153-200-444	144
973-374-492-157	209	984-153-100-444	148	992-154-000-004	149	993-154-000-000	144

COD	PAG
993-154-000-055	144
993-154-000-066	144
993-154-000-367	144
993-154-000-444	144
993-154-100-000	144
993-154-100-055	144
993-154-100-066	144
993-154-100-155	144
993-154-100-367	144
993-154-100-444	144
993-154-200-000	145
993-154-200-055	145
993-154-200-066	145
993-154-200-155	145
993-154-200-367	145
993-154-200-444	145
993-154-300-000	144
993-154-300-055	144
993-154-300-066	144
993-154-300-155	144
993-154-300-367	144
993-154-300-444	144
993-154-400-000	144
993-154-400-055	144
993-154-400-066	144
993-154-400-155	144
993-154-400-367	144
993-154-400-444	144
993-154-500-000	144
993-154-500-055	144
993-154-500-066	144
993-154-500-155	144
993-154-500-367	144
993-154-500-444	144
993-163-000-000	145
993-163-000-055	145
993-163-000-066	145
993-163-000-155	145
993-163-000-367	145
993-163-000-444	145
993-164-000-000	145
993-164-000-055	145
993-164-000-066	145
993-164-000-155	145
993-164-000-367	145
993-164-000-444	145
993-164-100-000	145
993-164-100-066	145
993-164-100-367	145
993-164-100-444	145
993-164-400-000	144
993-164-400-055	144
993-164-400-066	144
993-164-400-155	144
993-164-400-367	144
993-164-400-444	144
993-922-072-057	203
993-922-092-057	203
993-991-600-000	157
993-991-600-055	157
993-991-600-066	157
993-991-600-367	157
993-991-600-444	157
993-991-700-000	157
993-991-700-055	157
993-991-700-066	157
993-991-700-367	157

COD	PAG
993-991-700-444	157
993-991-900-000	157
993-991-900-055	157
993-991-900-066	157
993-991-900-367	157
993-991-900-444	157
D17-154-300-000	416
D17-154-300-0BQ	416
D17-154-300-001	416
D17-154-300-01M	416
D17-154-300-08F	416
D17-154-300-040	416
D17-154-300-047	416
D17-154-300-180	416
D17-154-300-367	416
D17-154-400-000	415
D17-154-400-0BQ	415
D17-154-400-001	415
D17-154-400-01M	415
D17-154-400-08F	415
D17-154-400-040	415
D17-154-400-047	415
D17-154-400-180	415
D17-154-400-367	415
D17-154-500-000	416
D17-154-500-0BQ	416
D17-154-500-001	416
D17-154-500-01M	416
D17-154-500-08F	416
D17-154-500-040	416
D17-154-500-047	416
D17-154-500-180	416
D17-154-500-367	416
D17-164-400-000	415
D17-164-400-0BQ	415
D17-164-400-001	415
D17-164-400-01M	415
D17-164-400-08F	415
D17-164-400-040	415
D17-164-400-047	415
D17-164-400-180	415
D17-164-400-367	415
D17-512-900-000	417
D17-512-900-0BQ	417
D17-512-900-001	417
D17-512-900-01M	417
D17-512-900-08F	417
D17-512-900-040	417
D17-512-900-047	417
D17-512-900-180	417
D17-512-900-367	417
J40-075-030-180	331
J40-075-035-180	331
J40-075-050-180	331
J40-383-031-180	334
J40-383-032-180	334
J40-383-900-180	334
J40-411-000-180	330
J40-411-110-180	330
J40-411-200-180	330
J40-511-000-180	326
J40-511-110-180	326
J40-511-200-180	326
J40-706-500-180	408
J40-716-000-180	408
J40-716-300-180	408
J40-716-400-180	408

COD	PAG
J40-C80-00E-180	331
J40-C80-10E-180	331
J40-C80-20E-180	331
J40-C81-00E-180	327
J40-C81-10E-180	327
J40-C81-20E-180	327
J40-D17-031-180	330
J40-D17-032-180	330
J40-D17-900-180	330
J40-D17-Y01-180	330
J40-Q75-030-180	327
J40-Q75-035-180	327
J40-Q75-050-180	327
J40-QD7-031-180	326
J40-QD7-032-180	326
J40-QD7-900-180	326
J40-QD7-Y03-180	326
J40-T80-00E-180	331
J40-T80-10E-180	331
J40-T80-20E-180	331
J40-T81-00E-180	327
J40-T81-10E-180	327
J40-T81-20E-180	327
QD7-124-900-180	417
QD7-154-300-180	417
QD7-154-400-180	416
QD7-154-500-180	416
QD7-164-400-180	416

 +39 0365 896186

 salesreguitti@tyman.com

 tyman-international.com

 Località Fondi
25071 Agnosine (BS) Italy



CREDITS

Der Katalog und die gezeigten Produkte sind Gegenstand von Aktualisierungen. Reguitti S.p.A. behält sich das Recht vor, alle Reguitti S.p.A. behält sich das Recht vor, ästhetische und technische Änderungen an seinen Produkten vorzunehmen, die seiner Meinung nach notwendig sind. Die Texturen und Farben der Oberflächen haben einen repräsentativen Wert. Die angegebenen Maße sind in Millimetern ausgedrückt.

The catalogue and the products shown are subject to updates. Reguitti S.p.A. reserves the right to make any aesthetic and technical changes to its products that in his opinion are necessary. The textures and colors of the finishes have a representative value. The indicated measures are expressed in millimeters.

Dieser Preisliste annulliert und ersetzt die vorherigen Jatc Preisliste
The present price list cancels and replaces all previous Reguitti price lists.

Im April 2024 fertig gedruckt
Printed on April 2024

OBERFLÄCHEN FINISHES

MATERIALEN: EDELSTAHL
MATERIAL: STAINLESS STEEL











































































































MATERIALEN: MESSING
MATERIAL: BRASS

MATERIALEN: ALUMINIUM
MATERIAL: ALUMINIUM

MATERIALEN: PORZELLAN
MATERIAL: PORCELAIN

MATERIALEN: TEKNOMETAL
MATERIAL: TEKNOMETAL

MATERIALEN: HOLZ
MATERIAL: WOOD

	02 Messing Poliert <i>Polished varnished</i>				8F Messing Brüniert 800 <i>Matt brushed bronzed</i>	
	05 Chrom <i>Polished chrome</i>				8N Porzellan Champagne / Messing Brüniert <i>Champagne porcelain / Matt brushed bronzed</i>	 
	09 Nickel Poliert <i>Polished nickel</i>				96 Ultra Schwarz Matt <i>PVD Satin black</i>	
	18 Schwarz RAL 9005 <i>Matt black RAL 9005</i>	 			98 Ultra Mattnickel <i>PVD Satin inox</i>	
	1M Messing Rustik <i>Rustic brass</i>				AC Alu Chrom <i>Chrome aluminium</i>	
	26 Messing Poliert / Chrom <i>Polished varnished / Chrome</i>				AN Alu Mattnickel <i>Brushed Nickel</i>	
	31 Mattnickel <i>Satin nickel</i>	 			BQ Messing Antik Braun <i>Antique brass</i>	
	43 Velourschrom <i>Matt silver</i>				F6 Edelstahl / Chrom <i>Stainless steel / Chrome</i>	 
	46 Ultra Messing <i>PVD Gold</i>				K1 Nickel Spiegelpoliert Plus <i>Polished nickel plus</i>	 
	47 Messing Altgrau <i>Old silver</i>				L6 Chrom / Schwarz <i>Chrome / Dark wood</i>	 
	52 Porzellan Weiß / Ultra Messing <i>White porcelain / PVD Gold</i>	 			NO A-Plus Satin Schwarz <i>Satin black</i>	
	53 Porzellan Schwarz / Ultra Messing <i>Black porcelain / PVD Gold</i>	 			NR A-Plus Schwarz RAL 9005 <i>Matt black RAL 9005</i>	
	54 Porzellan Weiß / Messing Altgrau <i>White porcelain / Old silver</i>	 			NW A-Plus Weiß RAL 9016 <i>Matt white RAL 9016</i>	
	56 Porzellan Schwarz / Messing Poliert <i>Black porcelain / Polished varnished</i>	 			P4 Porzellan Schwarz / Chrom <i>Black porcelain / Chrome</i>	 
	59 Porzellan Champagne / Messing Antik Braun <i>Champagne porcelain / Antique brass</i>	 			P5 Porzellan Schwarz / Satin Chrom <i>Black porcelain / Satin chrome</i>	 
	5E Messing Poliert / Edelstahl <i>Polished varnished / Stainless steel</i>	 			P6 Porzellan Weiß / Chrom <i>White porcelain / Chrome</i>	 
	50 Edelstahl Spiegelpoliert <i>Polished stainless steel</i>				P7 Porzellan Weiß / Satin Chrom <i>White porcelain / Satin chrome</i>	 
	5P Edelstahl / Schwarz <i>Stainless steel / Matt black</i>					
	5S Edelstahl <i>Stainless steel 304</i>					
	61 Porzellan Weiß / Messing Poliert <i>White porcelain / Polished varnished</i>	 				
	65 Porzellan Weiß / Messing Antik Braun <i>White porcelain / Antique brass</i>	 				
	6P Ultra Mettnickel / Schwarz <i>PVD Satin inox / Dark wood</i>	 				
	85 Porzellan Schwarz / Messing Altgrau <i>Black porcelain / Old silver</i>	 				
	8B Antik Nickel <i>Antique nickel</i>					
	8E Porzellan Champagne / Messing Rustik <i>Champagne porcelain / Rustic brass</i>	 				

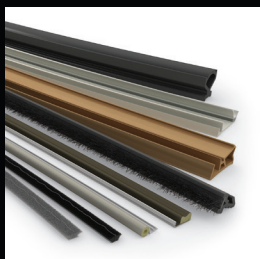

Schlegel

High performance sealing solutions



GIESSE

Innovative engineered hardware



REGUITTI

Italian design handles



DATEC

Timeless exclusive handles



 **TYMAN**
International

GIESSE S.p.A. Via Tubertini 1, 40054 Budrio (BO), Italia
Tel: +39 051 8850000 | email: info.it@tyman.com

UVCSPVUGENJA24XXX
05/2024

